

WebCal[®] Software Manual
EchoPod[®] DL10, DL14, DL24, DL34, DS14, DX10 & DX20 Series
EchoSonic[®] LU23, LU27, LU28 & LU29 Series
EchoWave[®] LG10 & LG11 Series

Configuration
Updates
Demo

Model Number DL24

Config

Number of Pumps

Switch/Alarms Only

Pump/Valve Action

Not Applicable

Pump/Valve Mode

Not Applicable

Relay Fail-Safe

Relays Off

Switch/Alarm Configuration

4-High

Switch Hysteresis/Deadband

No Hysteresis

Loop Fail-Safe

Hold Last Value

Output at Empty

4 mA at Bottom

Config #40

FLOWLINE[™]

Part Type: DL24, Serial Number: 1001 Firmware: LC3p00
Description: Switch, Cont & Trans, 118.1"(3.0m), 4 relays FW Rev: 1

Relay Units	Height Units	Sensor Height	Fill Height
Inches	Inches	118.1	114.1

Levels

Level	Height (Inches)
Hi-4	85.0
Hi-3	16.0
Hi-2	12.0
Hi-1	8.0

Vertical Cylinder

20mA

Sensor Height

Fill Height

4mA

Volumetric Mode

Notes

Write to Unit

Wiring Diagram

Advanced

Factory Config

Clear Screen

Config File Name

Open Config File

Save Config File

Print Config File

Help

WebCal® configuration software is a PC utility program that allows users to easily configure their EchoPod®, EchoSonic® or EchoWave® level sensors using pre-programmed function menus as the tank graphics and set point fields automatically change to match your configuration. Then input your level set point values, click **Write to Unit** and your configuration will be uploaded into the sensor. Last, click **Wiring Diagram** to open a wiring schematic of your configuration, print the document and wire the sensor per the schematic. It's that simple.

TABLE OF CONTENTS

System Requirements:	3
Safety Precautions:	4
Getting Started:	5
USB® Fob Interface:	6
Configuring EchoPod®, EchoSonic® or EchoWave® with WebCal®:	7
Sensor Configuration:	8
DL14, DL24, DL34 & DS14 Series:	8-14
DL10, LU23, LU27, LU28 & LU29 Series:	15-16
DX10 & DX20 Series:	17-19
LG10 & LG11 Series:	20-22
Dimensional Entry:	23
Distance vs. Volumetric Mode:	23
Shape Selection Window:	23
Vertical Cylindrical Tank Example:	24-25
Horizontal Cylindrical Tank Example:	26-27
Rectangular Tank Example:	28-29
Setting Relay Values:	30
Relay Configuration Examples:	31
Tank Level Configuration:	32
Write to Unit:	34
Wiring Diagram Sample:	35
Advanced Features:	36
Appendix:	38
Sample Program:	38
Updating WebCal® Software:	39
Updating Sensor Firmware:	40
Demo Page (LD10, LD14, LD24, DL34, DS14, DX10, DX20, LU23, LU27, LU28 & LU29 Series Only):	41
Diagnostics Page (LG10 & LG11 Series Only):	42-43
Strapping Table:	44
Linear vs. Non-Linear:	45-46
Troubleshooting:	47
Warranty, Returns and Limitations:	48

COMPUTER REQUIREMENTS

- Windows® 2000, XP, Vista, 7, 8, 10
- 32 or 64-bit system
- 1 USB® 2.0 port
- 10 mB hard drive space
- 256 mB RAM
- Internet connection

SENSOR REQUIREMENTS

EchoPod® Sensors	
DL10 Series	DL10-00, DL10-01, DL10-10, DL10-11
DL14 Series	DL14-00, DL14-01, DL14-10, DL14-11
DL24 Series	DL24-00, DL24-01, DL24-10, DL24-11
DL34 Series	DL34-00, DL34-01, DL34-10, DL34-11
DS14 Series	DS14-00, DS14-01, DS14-10, DS14-11
DX10 Series	DX10-00, DX10-01, DX10-10, DX10-11
DX20 Series	DX20-00, DX20-01, DX20-10, DX20-11

EchoSonic® Sensors	
LU23 Series	LU23-00, LU23-01, LU23-10, LU23-11, LU23-40, LU23-41, LU23-50, LU23-51
LU27 Series	LU27-00, LU27-01, LU27-10, LU27-11, LU27-40, LU27-41, LU27-50, LU27-51
LU28 Series	LU28-00, LU28-01, LU28-10, LU28-11, LU28-40, LU28-41, LU28-50, LU28-51, LU28-60, LU28-61, LU28-70, LU28-71
LU29 Series	LU29-00, LU29-01, LU29-10, LU29-11, LU29-40, LU29-41, LU29-50, LU29-51, LU29-60, LU29-61, LU28-90, LU29-71

EchoWave® Sensors	
LG10 Series	LG10-0003, LG10-0013, LG10-1003, LG10-1013, LG10-1103, LG10-1113
LG11 Series	LG11-2003, LG11-2013

INTERFACE REQUIREMENTS

- A Key Fob (LI99-1001) is required to interface the sensor with a computer. Sensors are sold with or without Fobs, and Fobs can be purchased separately.

■ **About this Manual:** PLEASE READ THE ENTIRE MANUAL PRIOR TO CONFIGURING A SENSOR, INSTALLING A SENSOR OR USING THIS SOFTWARE. This manual includes information on the WebCal® configuration software from FLOWLINE. Please refer to the sensor part number located on the sensor label to verify the exact model and its compatibility with WebCal® software.

■ **User's Responsibility for Safety:** FLOWLINE manufactures a broad range of level sensing technologies. While each of these sensors is designed to operate in a wide variety of applications, it is the user's responsibility to select a sensor model that is appropriate for the application, install it properly, perform tests on the installed system and maintain all components. The failure to do so could result in property damage or serious injury.

■ **Safety**

- Installation should always be done by properly trained staff.
- Supply voltage should never exceed a maximum of 28 VDC.
- The sensor must be chemically compatible with the application.
- Design a fail-safe system for possible sensor and/or power failure.
- Never configure the sensor in environments classified hazardous.

■ **Make a Fail-Safe System:** Design a fail-safe system that accommodates the possibility of sensor and/or power failure. FLOWLINE recommends the use of redundant backup systems and alarms in addition to the primary level system.

■ **Flammable, Explosive or Hazardous Applications:** WebCal® should not be used within classified hazardous environments.

DOWNLOAD AND INSTALL WEBCAL®

EchoPod®, EchoSonic® and EchoWave® are configured through WebCal® configuration software. **You must download and install WebCal® prior to plugging in the USB® Fob.** WebCal® is a free download. Go to www.flowline.com, select your language version, and download WebCal® to a compatible PC. Then double-click the WebCal® icon to install the software, and any missing drivers.

WebCal® Software

WebCal software is a PC utility program that enables users to easily configure and test compatible Flowline level sensors to their measurement and control requirements. Download your free copy in English or Chinese and connect your sensor through our Fob USB® adapter. Sensors are sold with and without Fobs. When connected to your level sensor, WebCal displays the factory or user configuration that was last written to the sensors non-volatile memory.

System Requirements

- Windows® XP, Vista, 7, 8
- 32 or 64-bit system
- USB® 2.0
- 10 mB hard disk space
- 256 mB RAM

Sensor Configuration

Downloads

English
WebCal Software
Manual

Chinese
WebCal 軟件

- A** Configure your sensor, update the firmware or demo your configuration prior to installation
- B** Select from preprogrammed drop down menus to create your level configuration
- C** Supports up to 175 sensor configurations
- D** View your sensor part number, serial number, description and firmware
- E** Customize set points to your level measurement or control requirements
- F** Change the proportional signal output from distance to linearized volume using the standard tank shapes or custom strapping table

CONNECT THE USB® FOB

EchoPod®, EchoSonic® and EchoWave® communicate with WebCal® through a USB® Fob interface. **Before plugging the Fob into your computer’s USB® port, make sure that you have installed WebCal® on your computer and all external power is disconnected from the sensor.** Then connect the Red, Green, White and Black wires from the sensor to the corresponding colored terminals on the Fob, tighten the screws on the terminals and plug the Fob into the USB® port on your computer.

EchoPod® & EchoSonic® (with NEMA 6 Enclosure) Wiring

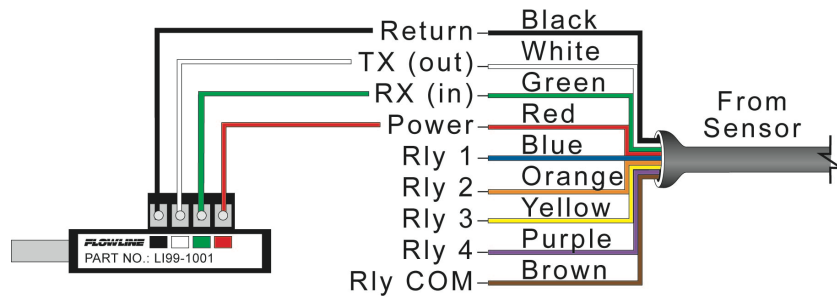

EchoPod® & EchoSonic® (with NEMA 4X Enclosure) Wiring

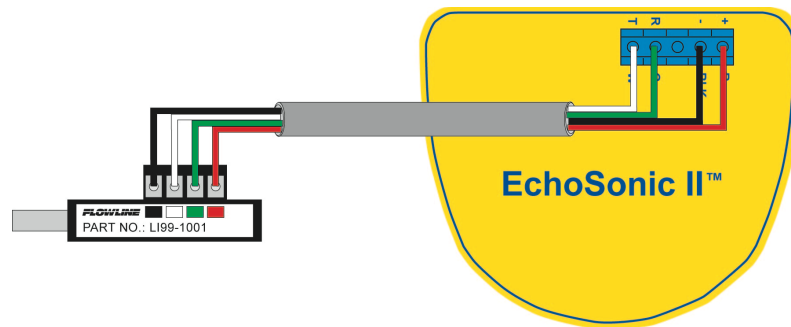

EchoWave® Wiring

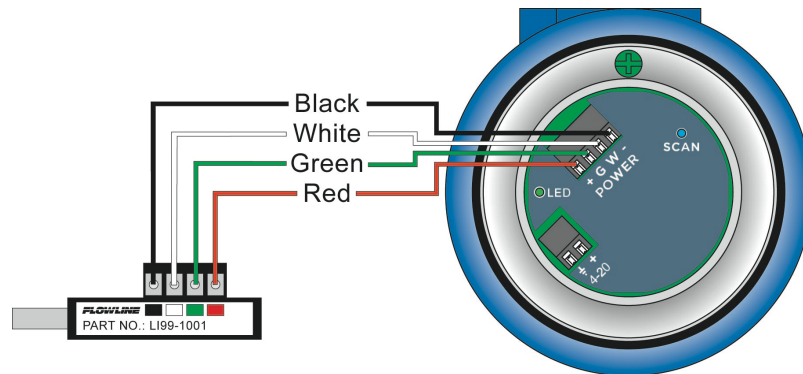

Wiring to the USB® Fob is identical for all sensors. Only use the Red, Black, Green and White wires. All other sensor wires and terminals are not used when connecting to the USB® Fob.

- When configuring the sensor, the maximum cable distance between the computer and sensor is 15’.
- Once the sensor is configured and prior to installation, isolate the White and Green wires from active power to prevent a short of the configuration circuit.
- When using the Fob, do not add external VDC or VAC power. When connected to the computer, the Fob will provide the required power to the sensor.

With EchoPod®, EchoSonic® or EchoWave® connected to your computer; open the WebCal® software by clicking on the WebCal® icon. Follow the steps below to configure the sensor. Click “Help” in the lower right hand corner and open the help menu of WebCal® for instructions on WebCal®.

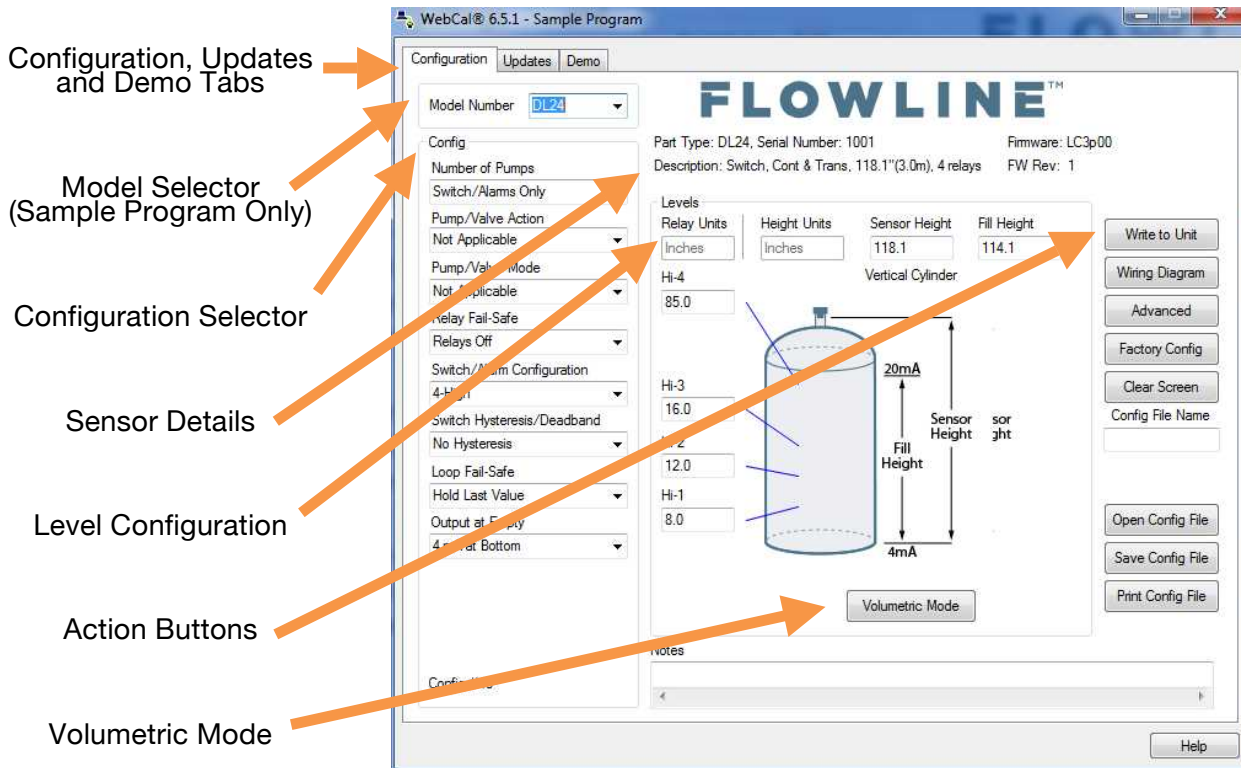

EchoPod® DL24 Series Screen Capture

CONFIGURING ECHOPOD® ECHOSONIC® OR ECHOWAVE® WITH WEBCAL®

1. Output Configuration
 - a. Defines the relay pump, valve or alarm and/or output operational settings.
 - b. Defines the relay and output (current, voltage or frequency) fail-safe settings.
2. Dimensional Configuration
 - a. Distance Mode (default)
 - i. Defines the dimensional information (Sensor Height, Probe Length & Maximum Fill-Height) with respect to the sensor’s location on the tank.
 - b. Volumetric Mode
 - i. To configure in volume versus distance (factory default), defines the tank shape and dimensional information with respect to the sensor’s location on the tank.
3. Setting Relay Values
 - a. This step is only active for DL14, DL24, DL34 and DS14 Series.
4. Tank Level Configuration
 - a. Defines the relay activation and output operational set points.
5. Write to Unit
 - a. Uploads the configuration into the sensor.
 - b. Prints a custom PDF wiring schematic.
 - c. Saves the configuration file for future use.

This section of WebCal® is where you select the level configuration settings. Start from the top and work to the bottom, choosing the selections that are applicable to your configuration. “**Not Applicable**” will automatically show when a selection doesn’t apply to your configuration settings, and you may move on. All configuration settings must be selected or have “**Not Applicable**” before you can continue to the next step.

Note: Pressing the Clear Screen button will reset the configuration table and allow access to all features.

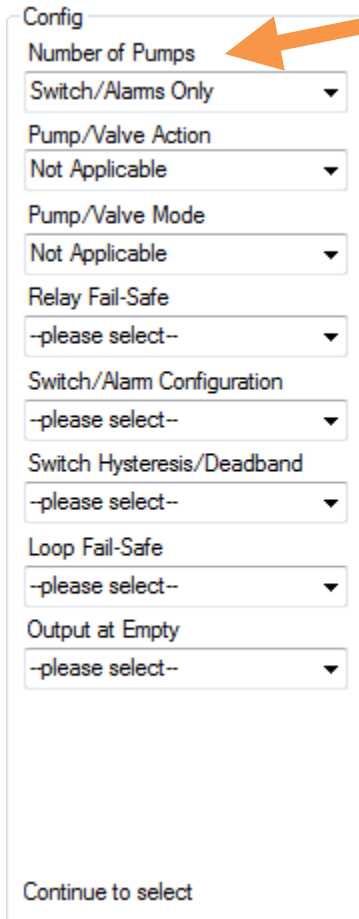

Config

Number of Pumps  Switch/Alarms Only ▼

Pump/Valve Action
Not Applicable ▼

Pump/Valve Mode
Not Applicable ▼

Relay Fail-Safe
-please select- ▼

Switch/Alarm Configuration
-please select- ▼

Switch Hysteresis/Deadband
-please select- ▼

Loop Fail-Safe
-please select- ▼

Output at Empty
-please select- ▼

Continue to select

Number of Pumps

This feature allows you to select the number of pumps or valves used with EchoPod®. This setting activates the control capabilities of one or two relays. Control relays are often referred to as latching relays.

- **Switch/Alarms Only** – The relays will be standard single point non-latching relays. Use this setting for high and/or low alarms.
- **1-Pump/Valve** – One relay will be configured as a control or latching relay (relay will have a start level and a separate stop level). Use this setting to control one pump or valve for automatic filling or emptying of a tank.
- **2-Pumps/Valves** – Two relays are configured as control or latching relays. Each relay will have a unique start level and a common stop level. Use this setting to control two pumps or valves for automatic filling or emptying of a tank.
- **4-20mA Transmitter Only** – This setting will disengage all of the relays. Use this function if you are not using any relays and using only the 4-20 mA current output.

Note: Right click on any item to open the help menu.

Note: To reset the configuration table, press the Clear Screen button.

Config

Number of Pumps
2-Pumps/Valves

Pump/Valve Action
Empties Tank

Pump/Valve Mode
-please select-

Relay Fail-Safe
-please select-

Switch/Alarm Configuration
-please select-

Switch Hysteresis/Deadband
-please select-

Loop Fail-Safe
-please select-

Output at Empty
-please select-

Continue to select

Pump/Valve Action

This feature allows you to select whether the pumps or valves will be used to automatically fill or empty the tank. For 2-Pump/Valve mode, both devices must be used in the same (automatic fill or empty) way. You cannot set one relay for fill and the other for empty.

- **Empties Tank** – Sets the relay(s) to automatically empty a tank. The start level will be above the Stop level for each relay.
- **Fills Tank** – Sets the relay(s) to automatically fill a tank. The start level will be below the Stop level for each relay.
- **Not Applicable** – Appears when this function is not available based on previous selections.

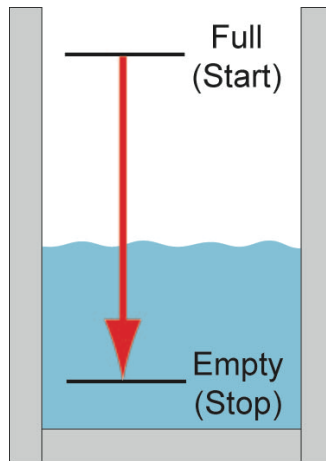

**Empties Tank
(Auto Empty)**

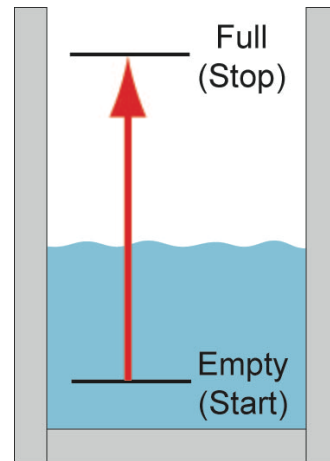

**Fills Tank
(Auto Fill)**

Note: Right click on any item to open the help menu.

Note: To reset the configuration table, press the Clear Screen button.

Config

Number of Pumps
2-Pumps/Valves

Pump/Valve Action
Empties Tank

Pump/Valve Mode
Duplex

Relay Fail-Safe
-please select-

Switch/Alarm Configuration
-please select-

Switch Hysteresis/Deadband
-please select-

Loop Fail-Safe
-please select-

Output at Empty
-please select-

Continue to select

Pump/Valve Mode

This feature allows you to select the control mode for a latching relay. Pump/Valve mode is not active for Switch/Alarms Only or 4-20 mA Transmitter Only.

- **Simplex** – Allows the relay to be used for automatic fill or empty. This is the default and only mode when **1-Pump/Valve** is selected.

- **Simplex used to Empty Tank**

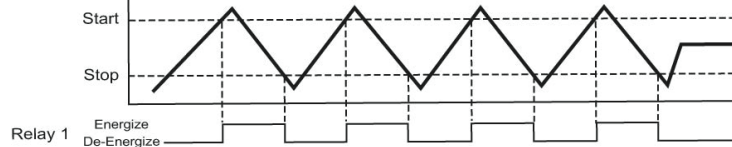

- **Lead/Lag** – Allows two relays to have unique start levels and a common stop level. The first relay will be identified as the lead relay and the second relay as the lag. Each time the lead level is reached, the first relay will always start. The lag relay will only start when the lag level is reached. All relays will stop at the common off level.

- **Lead/Lag used to Empty Tank**

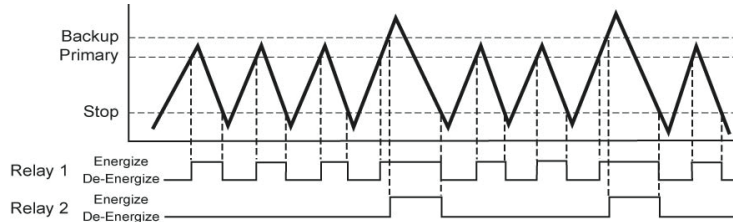

- **Duplex** – Allows two relays to have two different start levels, a common stop level and will alternate the relays when the first start level is reached. The two relays will alternate each time the lead level is reached and the remaining relay will start when the lag level is reached. All relays will stop at the common off level.

- **Duplex used to Empty Tank**

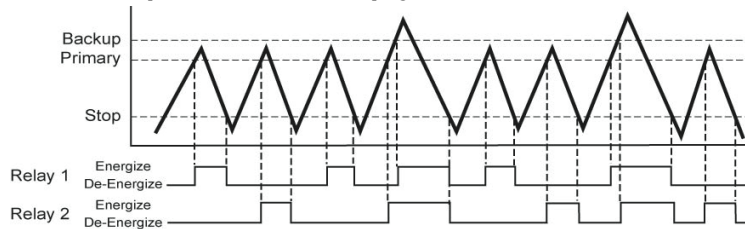

- **Not Applicable** – Appears when this function is not available based on previous selections.

Note: Right click on any item to open the help menu.

Note: To reset the configuration table, press the Clear Screen button.

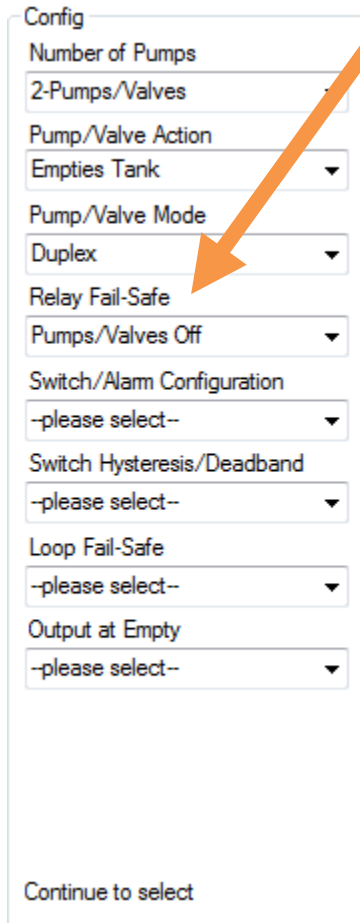

Config

Number of Pumps
2-Pumps/Valves

Pump/Valve Action
Empties Tank

Pump/Valve Mode
Duplex

Relay Fail-Safe
Pumps/Valves Off

Switch/Alarm Configuration
-please select-

Switch Hysteresis/Deadband
-please select-

Loop Fail-Safe
-please select-

Output at Empty
-please select-

Continue to select

Relay Fail-Safe

This feature allows you to select the fail-safe mode for the relays in the event that the sensor loses echo confidence. When the sensor regains echo confidence, the output current will revert back to the current level condition.

- **Relays Off** – The relays will revert to the OFF state. This appears when **Switch/Alarms Only** is selected.
- **Relays On** – The relays will revert to the ON state. This appears when **Switch/Alarms Only** is selected.
- **Hold State** – The relay(s) will remain in the same state as the last confident echo detected. When the sensor regains echo confidence, the relays will revert to the current level.
- **Pump/Valves Off** – The relays will revert to the OFF state. This appears when **1-Pump/Valve** or **2-Pumps/Valves** are selected.
- **Pump/Valves On** – The relays will revert to the ON state. This appears when **1-Pump/Valve** or **2-Pumps/Valves** are selected.
- **Not Applicable** – Appears when this function is not available based on previous selections.

Note: Right click on any item to open the help menu.

Note: To reset the configuration table, press the Clear Screen button.

Config

Number of Pumps
2-Pumps/Valves

Pump/Valve Action
Empties Tank

Pump/Valve Mode
Duplex

Relay Fail-Safe
Pumps/Valves Off

Switch/Alarm Configuration
1-Low, 1-High

Switch Hysteresis/Deadband
-please select-

Loop Fail-Safe
-please select-

Output at Empty
-please select-

Finish Selections

Switch/Alarm Configuration

This feature allows you to select the relay operation for the switch / alarm (used as a high or low alarm). The number of available relays is based upon the previous settings.

- **No Alarm** – Turns OFF all remaining relays.
- **High Alarms** – Sets 1 to 4 High Alarms (**1-High, 2-High, 3-High, 4-High**).
- **Low Alarms** – Set 1 to 4 Low Alarms (**1-Low, 2-Low, 3-Low or 4-Low**).
- **Combination Alarms** – Sets a combination of High and Low Alarms (**1-Low 1-High, 1-Low 2-High, 2-Low 1-High, 2-Low 2-High, 1-Low 3-High, 3-Low 1-High**).
- **Not Applicable** – Appears when this function is not available based on previous selections.

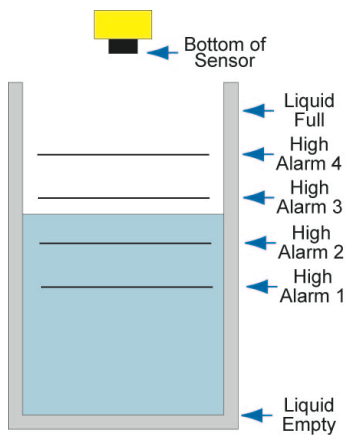

**High Alarm
(4 High)**

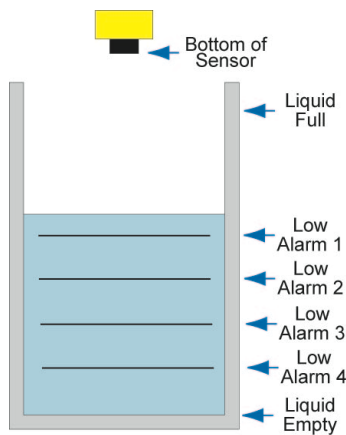

**Low Alarms
(4 Low)**

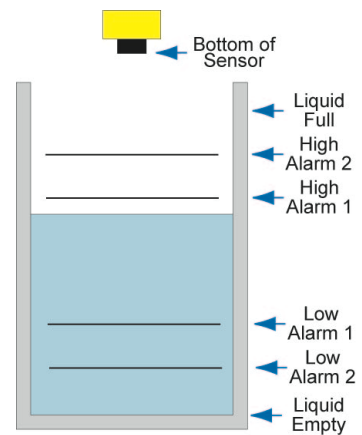

**Combination Alarms
(2 High and 2 Low)**

Note: Right click on any item to open the help menu.

Note: To reset the configuration table, press the Clear Screen button.

Config

Number of Pumps
2-Pumps/Valves

Pump/Valve Action
Empties Tank

Pump/Valve Mode
Duplex

Relay Fail-Safe
Pumps/Valves Off

Switch/Alarm Configuration
1-Low, 1-High

Switch Hysteresis/Deadband
Fixed 1/2"

Loop Fail-Safe
-please select-

Output at Empty
-please select-

Finish Selections

Switch Hysteresis/Dead band

This feature allows you to select a hysteresis or dead band for the remaining high and/or low alarms.

- Options for Hysteresis/Dead band – No Hysteresis, 1/4", 1/2", 1", 2", 1/2 cm, 1cm, 2 cm, 5 cm or Not Applicable.
- High Alarms** – Relay activates above the set point. Relay will deactivate when the level goes below the set point plus the value of the hysteresis.
- Low Alarms** – Relay activates below the set point. Relay will deactivate when the level goes above the set point plus the value of the hysteresis.

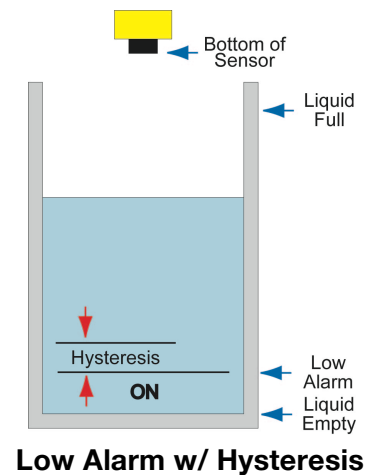
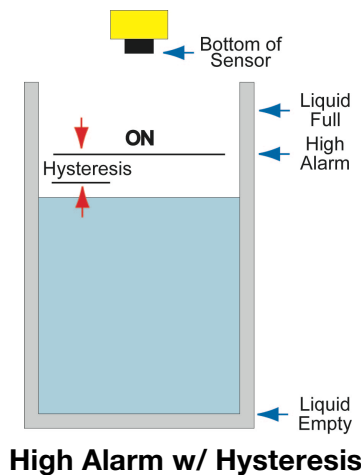

Note: Right click on any item to open the help menu.

Note: To reset the configuration table, press the Clear Screen button

Config #16

Config

Number of Pumps
2-Pumps/Valves

Pump/Valve Action
Empties Tank

Pump/Valve Mode
Duplex

Relay Fail-Safe
Pumps/Valves Off

Switch/Alarm Configuration
1-Low, 1-High

Switch Hysteresis/Deadband
Fixed 1/2"

Loop Fail-Safe
Empty

Output at Empty
4 mA at Bottom

Loop Fail-Safe – (Not Available on DS14 series)

This feature allows you to select the fail-safe current output if the sensor loses echo confidence. When the sensor regains echo confidence, the output current will revert back to the current level condition.

- **Hold Last Value** – The output will remain in the same state as the last confident echo detected. Example: If the output was 6.7 mA just prior to the lost signal, the sensor will continue to output 6.7 mA until echo confidence is regained.
- **Empty** - The output will revert to the current value for an empty condition. When **4 mA at Bottom** is selected, the sensor will output 4 mA during a fail-safe condition. If **20 mA at Bottom** is selected, the sensor will output 20 mA during a fail-safe condition.
- **Full** – The output will revert to the current value for a full condition. When **4 mA at Bottom** is selected, the sensor will output 20 mA during a fail-safe condition. If **20 mA at Bottom** is selected, the sensor will output 4 mA during a fail-safe condition.
- **Overfill (21mA)** – The sensor will output 21mA during a fail-safe condition.
- **Overfill (22mA)** – The sensor will output 22mA during a fail-safe condition.

Output at Empty – (Not Available on DS14 series)

This feature allows you to select the orientation of the 4 to 20mA output (4 to 20 mA or 20 to 4 mA). Choose which output setting best fits the application. Typical applications are set with **4 mA at Bottom**. Factory default is 4mA at bottom and 20mA at top. When connecting your sensor to a display, you must account for your output orientation setting.

- **4mA at Bottom** – The output current will be 4mA when the sensor measures an empty tank and 20mA when the sensor measures a full tank.
- **20mA at Bottom** – The output current will be 20mA when the sensor measures an empty tank and 4mA when the sensor measures a full tank.

Note: Right click on any item to open the help menu.

Note: To reset the configuration table, press the Clear Screen button

Config

Loop Fail-Safe
Hold Last Value

Output at Empty
4 mA at Bottom

Startup Condition
Empty

Config #0

Loop Fail-Safe

This feature allows you to select the fail-safe current output if the sensor loses echo confidence. When the sensor regains echo confidence, the output current will revert back to the current level condition.

- **Hold Last Value** – The output will remain in the same state as the last confident echo detected. Example: If the output was 6.7 mA just prior to the lost signal, the sensor will continue to output 6.7 mA until echo confidence is regained.
- **Empty** - The output will revert to the current value for an empty condition. When **4 mA at Bottom** is selected, the sensor will output 4 mA during a fail-safe condition. If **20 mA at Bottom** is selected, the sensor will output 20 mA during a fail-safe condition.
- **Full** – The output will revert to the current value for a full condition. When **4 mA at Bottom** is selected, the sensor will output 20 mA during a fail-safe condition. If **20 mA at Bottom** is selected, the sensor will output 4 mA during a fail-safe condition.
- **Overfill (21mA)** – The sensor will output 21mA during a fail-safe condition.
- **Overfill (22mA)** – The sensor will output 22mA during a fail-safe condition.

Output at Empty

This feature allows you to select the orientation of the 4 to 20mA output (4 to 20 mA or 20 to 4 mA). Choose which output setting best fits the application. Typical applications are set with **4 mA at Bottom**. Factory default is 4mA at bottom and 20mA at top. When connecting your sensor to a display, you must account for your output orientation setting.

- **4mA at Bottom** – The output current will be 4mA when the sensor measures an empty tank and 20mA when the sensor measures a full tank.
- **20mA at Bottom** – The output current will be 20mA when the sensor measures an empty tank and 4mA when the sensor measures a full tank.

Note: Right click on any item to open the help menu.

Note: To reset the configuration table, press the Clear Screen button

Config

Loop Fail-Safe

Hold Last Value

Output at Empty

4 mA at Bottom

Startup Condition

Empty

Config #0

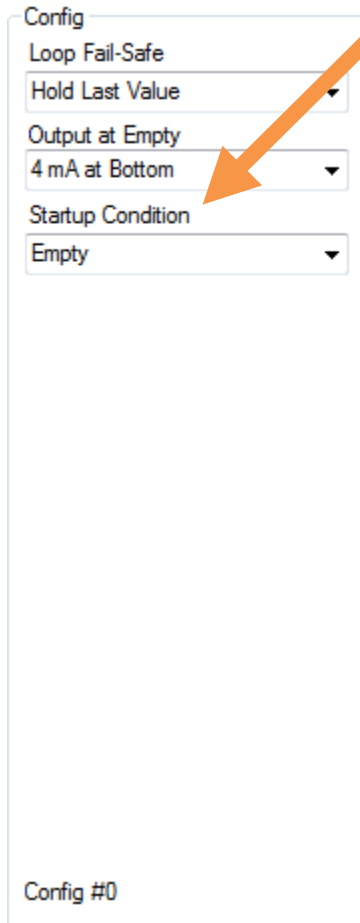

Startup Condition

This feature allows you to select the startup current when power is first applied to the sensor. The sensor will consume the selected power while it is acquiring the liquid level. When the correct level has been identified, the output will adjust to the level output. Use this feature to avoid false alarms with the controller when power is first applied to the sensor.

- **Empty** - The current output will revert to the current value for an empty condition. When **4 mA at Bottom** is selected, the sensor will output 4 mA while the sensor powers up. If **20 mA at Bottom** is selected, the sensor will output 20 mA while the sensor powers up.
- **Mid Tank (12 mA)** – The sensor will output 12 mA while the sensor powers up.
- **Full** – The output will revert to the current value for a full condition. When **4 mA at Bottom** is selected, the sensor will output 20 mA while the sensor powers up. If **20 mA at Bottom** is selected, the sensor will output 4 mA while the sensor powers up.
- **Overfill (22mA)** – The sensor will output 22mA while the sensor powers up.

Note: Right click on any item to open the help menu.

Note: To reset the configuration table, press the Clear Screen button

Config

Select Output
-please select-

Maximum Output
-please select-

Minimum Output
-please select-

Output at Empty
-please select-

Fail-Safe Output
-please select-

Startup Condition
-please select-

Continue to select

Select Output

This feature allows you to select the output for the DX10 & DX20 series. The output can either be voltage or frequency.

- **Voltage** – Select this option for a voltage output. You will be able to select voltage scale of 0-2.5V, 0-3.3V, 0-5V or 0-10V.
- **Frequency** – Select this option for a frequency/pulse output. The output will be fixed from 976 to 2000 Hz.

Maximum Output

This sets the maximum output for the DX10 & DX20 series. If voltage is selected, then the maximum value will be in volts. If frequency is selected, then the maximum value will be in hertz.

- **Voltage** – Choose from: 2.5 volts, 3.3 volts, 5 volts or 10 volts.
- **Frequency** – This value is fixed at 2000 Hz.

Minimum Output

This sets the minimum output for the DX10 & DX20 series. If voltage is selected, then the minimum value will be in volts. If frequency is selected, then the minimum value will be in hertz.

- **Voltage** – Choose from: 0.25 volts, 0.5 volts, 0.833 volts, 1 volt or 2 volts.
- **Frequency** – This value is fixed at 976 Hz.

Note: Right click on any item to open the help menu.

Note: To reset the configuration table, press the Clear Screen button

Config

Select Output
-please select-

Maximum Output
-please select-

Minimum Output
-please select-

Output at Empty
-please select-

Fail-Safe Output
-please select-

Startup Condition
-please select-

Continue to select

Output at Empty

This feature allows you to select the orientation of the voltage or frequency output (ex. Empty = 1 volt and full = 10 volts vs. empty = 10 volts and full = 1 volt). Choose which output setting best fits the application. Typical installations are set with **Minimum Output**. When connecting your sensor to a display, you must account for your output orientation setting.

- **Minimum Output** – The output will be the smallest value. If reading in voltage, this will be the minimum output voltage. If reading in frequency, this will be 976 Hz.
- **Maximum Output** – The output will be the largest value. If reading in voltage, this will be the maximum output voltage. If reading in frequency, this will be 2000 Hz.

Fail-Safe Output

This feature allows you to select the fail-safe output if the sensor loses signal confidence. When the sensor regains echo confidence, the output will revert back to the current level condition.

- **Hold Last Value** – The output will remain in the same state as the last confident echo detected. Example: If the output was 6.7 volts just prior to the lost signal, the device will continue to output 6.7 volts until echo confidence is regained.
- **Empty** - The output will revert to the set value for an empty condition. When **Minimum Output** is selected, the sensor will output the lowest voltage or frequency value during a fail-safe condition. If **Maximum Output** is selected, the sensor will output the highest voltage or frequency value during a fail-safe condition.
- **Full** – The output will revert to the set value for a full condition. When **Minimum Output** is selected, the sensor will output the highest voltage or frequency value during a fail-safe condition. If **Maximum Output** is selected, the sensor will output the lowest voltage or frequency value during a fail-safe condition.

Note: Right click on any item to open the help menu.

Note: To reset the configuration table, press the Clear Screen button

Config

Select Output
-please select-

Maximum Output
-please select-

Minimum Output
-please select-

Output at Empty
-please select-

Fail-Safe Output
-please select-

Startup Condition
-please select-

Continue to select

Startup Condition

This feature allows you to select the startup output when power is first applied to the sensor. The sensor will output the selected signal while it is acquiring the liquid level. When the correct level has been identified, the output will adjust to the level output. Use this feature to avoid false alarms with the controller when power is first applied to the sensor.

- **Empty** - The output will revert to the set value for an empty condition. When **Minimum Output** is selected, the sensor will output the lowest voltage or frequency value until the level is acquired. If **Maximum Output** is selected, the sensor will output the highest voltage or frequency value until the level is acquired.
- **Mid Tank** - The output will hold at the mid level of the **Minimum** and **Maximum Output** until the level is acquired.
- **Full** - The output will revert to the set value for a full condition. When **Minimum Output** is selected, the sensor will output the highest voltage or frequency value until the level is acquired. If **Maximum Output** is selected, the sensor will output the lowest voltage or frequency value until the level is acquired.

Note: Right click on any item to open the help menu.

Note: To reset the configuration table, press the Clear Screen button

This section of WebCal® is where you select the level configuration settings. Start from the top and work to the bottom, choosing the selections that are applicable to your configuration. “**Not Applicable**” will automatically show when a selection doesn’t apply to your configuration settings, and you may move on. All configuration settings must be selected or have “**Not Applicable**” before you can continue to the next step.

Note: Pressing the Clear Screen button will reset the configuration table and allow access to all features.

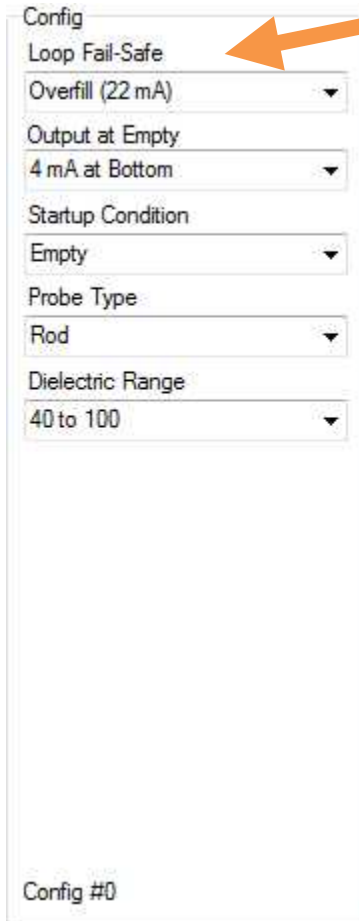

Config

Loop Fail-Safe

Overfill (22 mA) ▼

Output at Empty

4 mA at Bottom ▼

Startup Condition

Empty ▼

Probe Type

Rod ▼

Dielectric Range

40 to 100 ▼

Config #0

Loop Fail-Safe

This feature allows you to select the fail-safe current output if the sensor loses echo confidence. When the sensor regains echo confidence, the output current will revert back to the current level condition.

- **Hold Last Value** – The output will remain in the same state as the last confident echo detected. Example: If the output was 6.7 mA just prior to the lost signal, the sensor will continue to output 6.7 mA until echo confidence is regained.
- **Empty** - The output will revert to the current value for an empty condition. When **4 mA at Bottom** is selected, the sensor will output 4 mA during a fail-safe condition. If **20 mA at Bottom** is selected, the sensor will output 20 mA during a fail-safe condition.
- **Full** – The output will revert to the current value for a full condition. When **4 mA at Bottom** is selected, the sensor will output 20 mA during a fail-safe condition. If **20 mA at Bottom** is selected, the sensor will output 4 mA during a fail-safe condition.
- **Overfill (21mA)** – The sensor will output 21mA during a fail-safe condition.
- **Overfill (22mA)** – The sensor will output 22mA during a fail-safe condition.

Note: Right click on any item to open the help menu.

Note: To reset the configuration table, press the Clear Screen button.

Config

Loop Fail-Safe

Overfill (22 mA) ▼

Output at Empty ▼

4 mA at Bottom ▼

Startup Condition ▼

Empty ▼

Probe Type ▼

Rod ▼

Dielectric Range

40 to 100

Config #0

Output at Empty – (Not Available on DS14 series)

This feature allows you to select the orientation of the 4 to 20mA output (4 to 20 mA or 20 to 4 mA). Choose which output setting best fits the application. Typical applications are set with **4 mA at Bottom**. Factory default is 4mA at bottom and 20mA at top. When connecting your sensor to a display, you must account for your output orientation setting.

- 4mA at Bottom – The output current will be 4mA when the sensor measures an empty tank and 20mA when the sensor measures a full tank.
- 20mA at Bottom – The output current will be 20mA when the sensor measures an empty tank and 4mA when the sensor measures a full tank.

Startup Condition

This feature allows you to select the startup current when power is first applied to the sensor. The sensor will consume the selected power while it is acquiring the liquid level. When the correct level has been identified, the output will adjust to the level output. Use this feature to avoid false alarms with the controller when power is first applied to the sensor.

- **Empty** - The current output will revert to the current value for an empty condition. When **4 mA at Bottom** is selected, the sensor will output 4 mA while the sensor powers up. If **20 mA at Bottom** is selected, the sensor will output 20 mA while the sensor powers up.
- **Mid Tank (12 mA)** – The sensor will output 12 mA while the sensor powers up.
- **Full** – The output will revert to the current value for a full condition. When **4 mA at Bottom** is selected, the sensor will output 20 mA while the sensor powers up. If **20 mA at Bottom** is selected, the sensor will output 4 mA while the sensor powers up.
- **Overfill (22mA)** – The sensor will output 22mA while the sensor powers up.

Note: Right click on any item to open the help menu.

Note: To reset the configuration table, press the Clear Screen button.

Config

Loop Fail-Safe

Overfill (22 mA)

Output at Empty

4 mA at Bottom

Startup Condition

Empty

Probe Type

Rod

Dielectric Range

40 to 100

Config #0

Probe Type

This feature allows you to select the type of probe attached to the feed-through. It is critical to select the correct type of probe.

- **Rod** - Recommended for installations in liquids, in bypass chambers and stilling wells (when combined together with the rod emulate a coaxial probe).
- **Cable** - Recommended for installations in tall tanks and where limited headroom is available.
- **Coaxial** - Recommended for the use with clean liquids only. It cannot be used with viscous, crystallizing, adhesive, coating, or sticky liquids; fibrous liquids, sludge, slurry, pulp or any liquids containing solid particles.

Dielectric Range

This feature allows you to select the dielectric range, which sets the amplitude threshold within the sensor.

- Water based media (water, H2SO4, HCl)
 - **40 to 100**
 - **20 to 39.9**
 - **10 to 19.9**
- Varying dielectrics (Alcohols, Ethyl Acetate, Caster Oil)

○ 9 to 9.9	○ 5 to 5.9
○ 8 to 8.9	○ 4 to 4.9
○ 7 to 7.9	○ 3 to 3.9
○ 6 to 6.9	
- Typical Hydrocarbons (Diesel Fuel, Mineral Oil, Solvents)
 - **2 to 2.9**

Note: Right click on any item to open the help menu.

Note: To reset the configuration table, press the Clear Screen button.

DISTANCE VS. VOLUMETRIC MODE

1. **Distance Mode (default):** Output of sensor is based on the distance (height of liquid) in the tank. Any change in liquid level will reflect linearly to the current output. **Note:** Most applications will fall into this category. Distance (height of liquid) will be configured and referenced in units of inches, cm, feet or meters.
 - a. **Ultrasonic Sensors:** The two settings you must enter for Distance Mode are Sensor Height and Fill-Height. Both settings can be entered on the main configuration screen.
 - b. **GWR Sensors:** The three settings you must enter for Distance Mode are Sensor Height, Probe Length and Maximum Fill-Height. All three settings can be entered on the main configuration screen.
2. **Volumetric Mode:** Allows the end user to switch from the standard distance output to an output based upon the volumetric shape of the tank. In Volumetric Mode, the shape of the tank is first selected followed by the entry of dimensional information for the tank with respect to the sensor's location on the tank. Volume will be configured in units of inches, cm, feet or meters and referenced in units of gallons or liters.

Press the Volumetric Mode button (on main Configuration Window) to begin the dimensional entry. Upon clicking, use the Shape Selection Window to choose a tank shape that best matches your application.

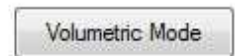

SHAPE SELECTION WINDOW

This window will show the different tank shape options available in WebCal®.

- **Vertical Cylindrical**
- **Vertical Cylindrical with Cone Bottom**
- **Horizontal Cylindrical with End Caps**
- **Horizontal Cylindrical with Spherical Ends**
- **Spherical**
- **Rectangular**
- **Strapping Table** – Use this feature for manual entry of measured tank distances and volumes.

Select any of the above tank shapes and press OK to confirm.

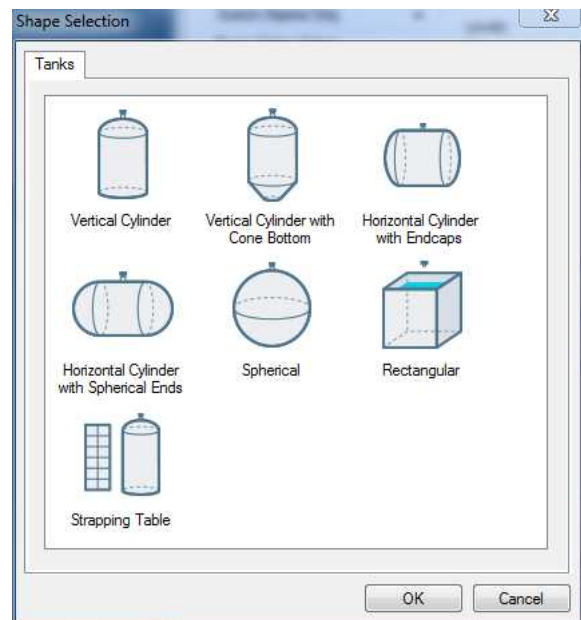

Note: While in Volumetric Mode, the sensor may be switched between Distance and Volumetric outputs (under Sensor Output Units). When Distance is selected the units are inches, cm, feet or meters. When Volume is selected, the units are Gallons or Liters. The type of configuration output (Volumetric or Distance) and the measured units may be changed under Sensor Output Units.

VERTICAL CYLINDRICAL TANK EXAMPLE

Choose the Sensor Output Units as Distance or Volume. After choosing the Sensor Output Units, select the units of measurement in the pull down to the left.



Units of Measurement	
Distance	Volume
Inches	Gallons
Cm	Liters
Feet	
Meters	

Distance – Sensor Output Units:

Enter the dimensions of the tank. You must enter data in all fields shown.

Sensor Height: Distance from the bottom of the tank to the bottom of the transducer.

Fill Height: Distance from the bottom of the tank to the maximum liquid height.

Riser Height: Distance the sensor is recessed within a riser, measured from the bottom of the sensor to the inside of the tank.

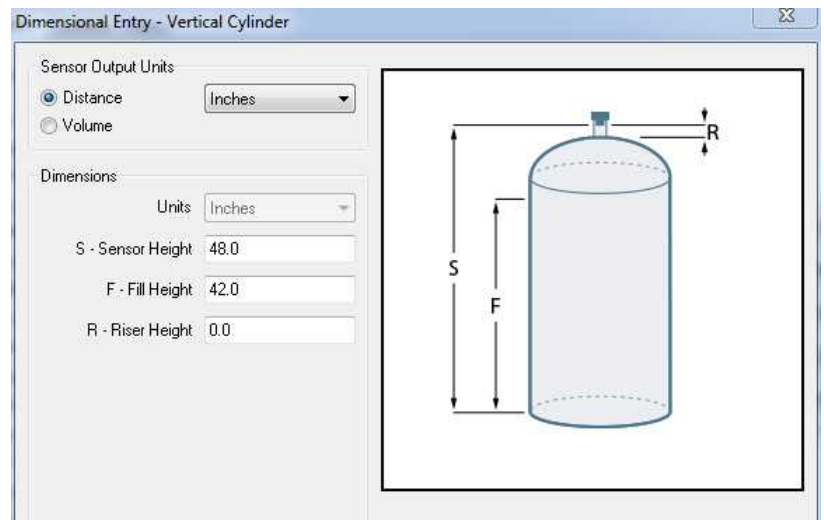

Volume – Sensor Output Units:

Enter the dimensions of the tank. You must enter data in all fields shown.

Sensor Height: Distance from the bottom of the tank to the bottom of the transducer.

Fill Height: Distance from the bottom of the tank to the maximum liquid height.

Riser Height: Distance the sensor is recessed within a riser, measured from the bottom of the sensor to the inside of the tank.

Tank Height: Distance from the bottom of the tank to the top of the straight side wall.

Diameter: Distance of the inside tank diameter.

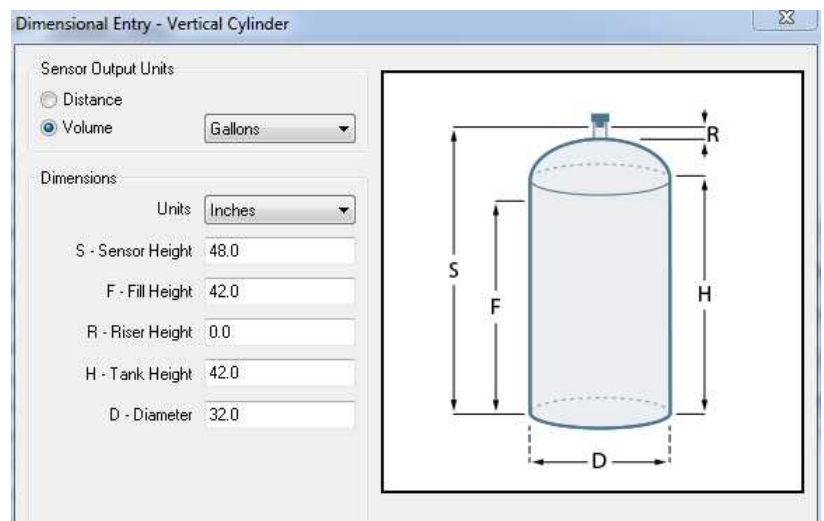

Volume – Tank Capacity: After entering the dimensions, press the Capacity button to show the Calculated Capacity of the tank. If the Calculated Capacity is slightly different than the expected capacity, click on the Adjust Capacity box and enter the expected capacity of the tank. If the Adjusted Capacity is more than 10% of the Calculated Capacity, recheck the dimensions information entered above.



The image shows two side-by-side screenshots of a software dialog box titled "Volume".

The left screenshot shows a "Capacity" button, a text field containing "146.23", an unchecked "Adjust Capacity" checkbox, and an empty "Capacity" text field.

The right screenshot shows the same "Capacity" button and "146.23" text field. The "Adjust Capacity" checkbox is now checked, and the "Capacity" text field below it contains the value "150.0".

When all dimensions are entered, press the Apply button to return to the previous Configuration window.



The image shows a horizontal row of four buttons within a dialog box:

- Apply
- Select Tank Shape
- Cancel
- Help

- **Apply** – Transfers the dimensions to the original Configuration window.
- **Tanks** – Returns to the previous Shape Selection window.
- **Cancel** – Returns to the Configuration window without saving any information.
- **Help** – Jumps to the Help menu.

HORIZONTAL CYLINDRICAL TANK WITH END CAPS EXAMPLE

Choose the Sensor Output Units as Distance or Volume. After choosing the Sensor Output Units, select the units of measurement in the pull down to the left.



Units of Measurement	
Distance	Volume
Inches	Gallons
Cm	Liters
Feet	
Meters	

Distance – Sensor Output Units:

Enter the dimensions of the tank. You must enter data in all fields shown.

Sensor Height: Distance from the bottom of the tank to the bottom of the transducer.

Fill Height: Distance from the bottom of the tank to the maximum liquid height.

Riser Height: Distance the sensor is recessed within a riser, measured from the bottom of the sensor to the inside of the tank.

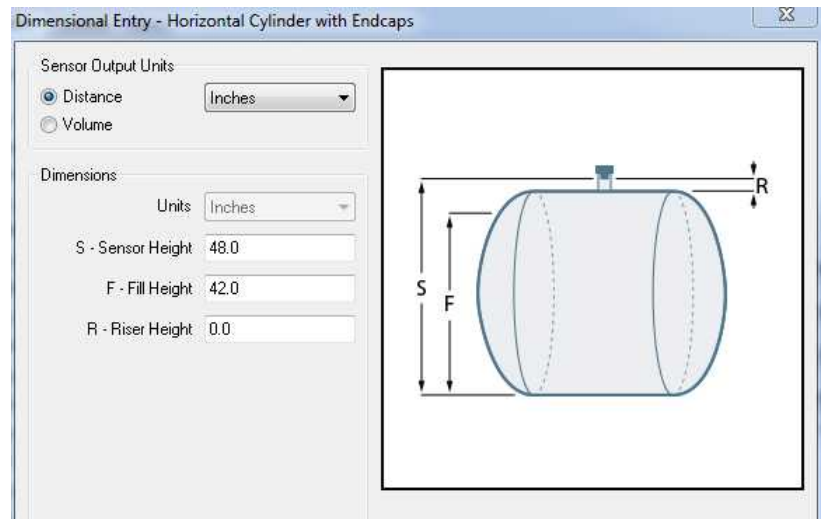

Volume – Sensor Output Units:

Enter the dimensions of the tank. You must enter data in all fields shown.

Sensor Height: Distance from the bottom of the tank to the bottom of the transducer.

Fill Height: Distance from the bottom of the tank to the maximum liquid height.

Riser Height: Distance the sensor is recessed within a riser, measured from the bottom of the sensor to the inside of the tank.

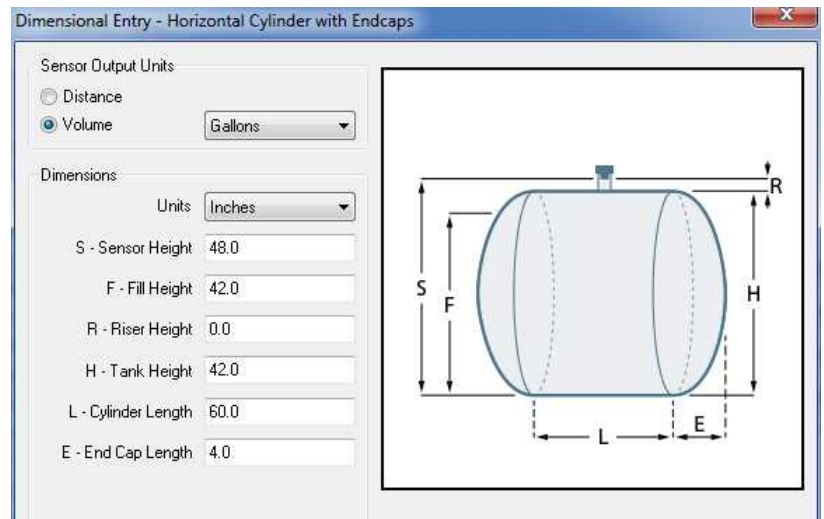

Tank Height: Distance from the bottom of the tank to the top of the straight side wall.

Cylinder Length: Distance of the straight length of the tank.

End Cap Length: Distance of one end cap. Both end caps will be used in the volume calculation.

Volume – Tank Capacity: Upon entering the dimensions, press the Capacity button to show the Calculated Capacity of the tank. If the Calculated Capacity is slightly different than the expected capacity, click on the Adjust Capacity box and enter the expected capacity of the tank. If the Adjusted Capacity is more than 10% of the Calculated Capacity, recheck the dimensions entered above.



The image shows two side-by-side screenshots of a software interface. Both screenshots are titled 'Volume:'.
The left screenshot shows a 'Capacity' button highlighted in blue, with a text box next to it containing the value '391.84'. Below this is an unchecked checkbox labeled 'Adjust Capacity' and an empty text box labeled 'Capacity'.
The right screenshot shows the same interface, but the 'Adjust Capacity' checkbox is now checked. The 'Capacity' text box now contains the value '400.0'.

When all dimensions are entered is completed, press the Apply button to return to the previous Configuration window.



The image shows a horizontal row of four buttons within a light gray rectangular frame. From left to right, the buttons are labeled 'Apply', 'Select Tank Shape', 'Cancel', and 'Help'.

- **Apply** – Transfers the dimensions back to the original Configuration window.
- **Tanks** – Returns to the previous Shape Selection window.
- **Cancel** – Returns to the Configuration window without saving any information.
- **Help** – Jumps to the Help menu.

RECTANGULAR TANK EXAMPLE

Choose the Sensor Output Units as Distance or Volume. After choosing the Sensor Output Units, select the units of measurement in the pull down to the left.



Units of Measurement	
Distance	Volume
Inches	Gallons
Cm	Liters
Feet	
Meters	

Distance – Sensor Output Units:

Enter the dimensions of the tank. You must enter data in all fields shown.

Sensor Height: Distance from the bottom of the tank to the bottom of the transducer.

Fmax - Fill Height: Distance from the bottom of the tank to the maximum liquid height.

Probe Length: Distance from the bottom of the threads to the end of the probe.

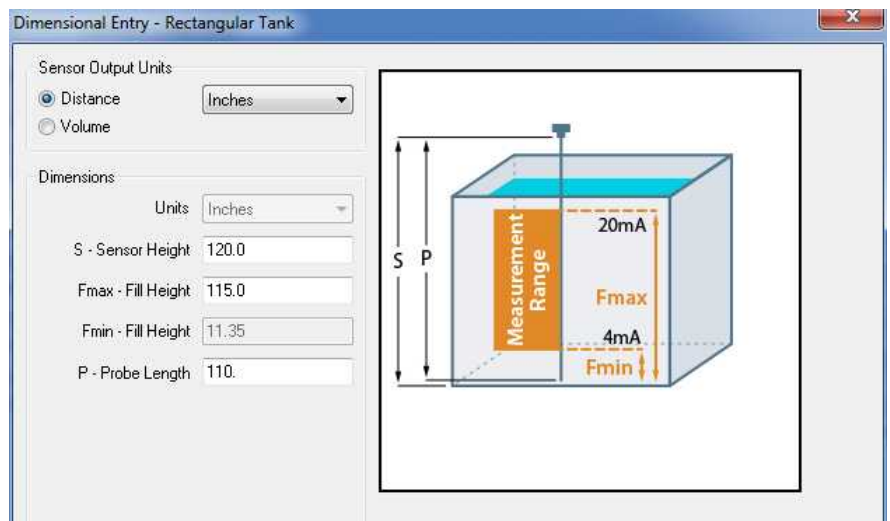

Volume – Sensor Output Units:

Enter the dimensions of the tank. You must enter data in all fields shown.

Sensor Height: Distance from the bottom of the tank to the bottom of the transducer.

Fmax - Fill Height: Distance from the bottom of the tank to the maximum liquid height.

Probe Length: Distance from the bottom of the threads to the end of the probe.

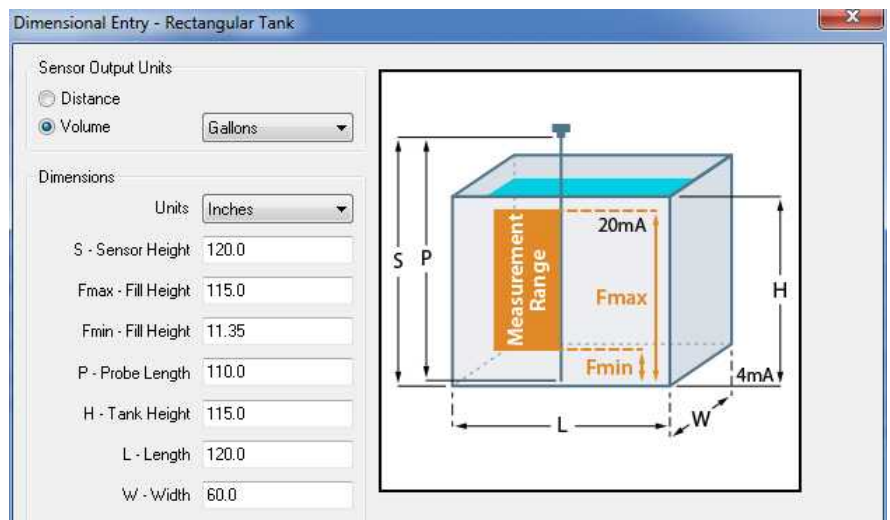

Tank Height: Distance from the bottom of the tank to the top of the tank.

Length: Distance of the straight length of the tank.

Width: Distance of the straight width of the tank.

Volume – Tank Capacity: Upon entering the dimensions, press the Capacity button to show the Calculated Capacity of the tank. If the Calculated Capacity is slightly different than the expected capacity, click on the Adjust Capacity box and enter the expected capacity of the tank. If the Adjusted Capacity is more than 10% of the Calculated Capacity, recheck the dimensions entered above.

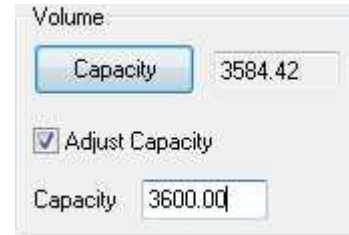
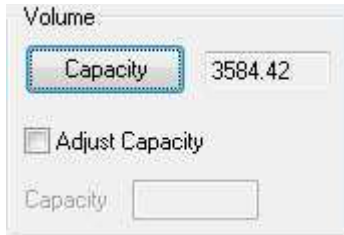

Minimum Current / Minimum Volume: When in Volume mode, the 4mA output is placed at the bottom of the tank (4.0mA = empty tank). Because of the dead band at the end of the probe as well as the probe may not extend to the bottom of the tank, there is a blank space where liquid will not be measured. WebCal can calculate the current and volume at this level in the tank. This is known as the Minimum Current and Minimum Volume. Click on the Min Current/Volume to show the calculated values. This is the lowest current and volume that the sensor will measure.

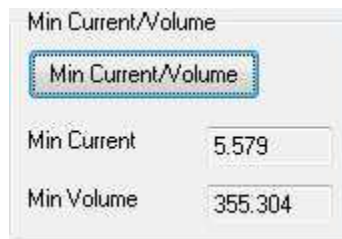

When all dimensions are entered is completed, press the Apply button to return to the previous Configuration window.



- **Apply** – Transfers the dimensions back to the original Configuration window.
- **Tanks** – Returns to the previous Shape Selection window.
- **Cancel** – Returns to the Configuration window without saving any information.

Help – Jumps to the Help menu.

The operational values for the relays are entered in this section. You must enter values within all fields shown. All values must be in the unit of operation listed under Relay Units. To change units, go back to the Dimensional entry page. **Note:** All relay values must be greater than an empty tank (0 units) and less than a full tank (Fill Height or Capacity Volume).

Configuration | Updates | Demo

Model Number: DL24

Part Type: DL24, **Serial Number:** 1001, **Firmware:** LC3p00
Description: Switch, Cont & Trans, 118.1"(3.0m), 4 relays, **FW Rev:** 1

Relay Units: Inches | **Height Units:** Inches | **Sensor Height:** 118.1 | **Fill Height:** 114.1

Level	Value
Hi-4	85.0
Hi-3	16.0
Hi-2	12.0
Hi-1	8.0

Vertical Cylinder
 20mA (Sensor Height)
 4mA (Fill Height)
 Volumetric Mode

Notes:

Config #40

Buttons: Write to Unit, Wiring Diagram, Advanced, Factory Config, Clear Screen, Config File Name, Open Config File, Save Config File, Print Config File, Help

RELAY CONFIGURATION EXAMPLES

4 High Level Alarms:

This example features 4-high Level Alarms. All values are configured in inches.

- Hi-4 = 20.0"
- Hi-3 = 16.0"
- Hi-2 = 12.0"
- Hi-1 = 8.0"

As the level increases (from the bottom up), each relay will energize. As the level lowers, the relay will de-energize in reverse order.

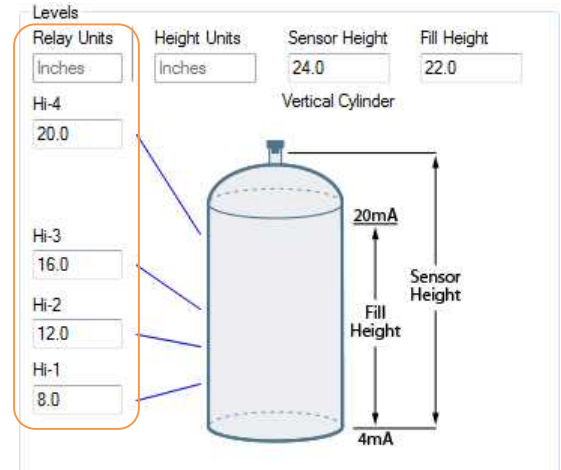

Lead/Lag Pump Empty with High Level Alarm:

This example features dual pumps in a lead lag configuration. There is also a high alarm used to warn of a tank overflow. All values are configured in inches.

- Hi = 38.0"
- On = 36.0"
- Off = 34.0"
- Low = 10.0"

Typically, the level is maintained between the ON (34") and Off (12") level for the pump empty. If the level ever reaches the Lag level (36"), the second pump will activate to help empty the tank. If the level ever reaches the High Alarm level (38"), then an alarm will be activated.

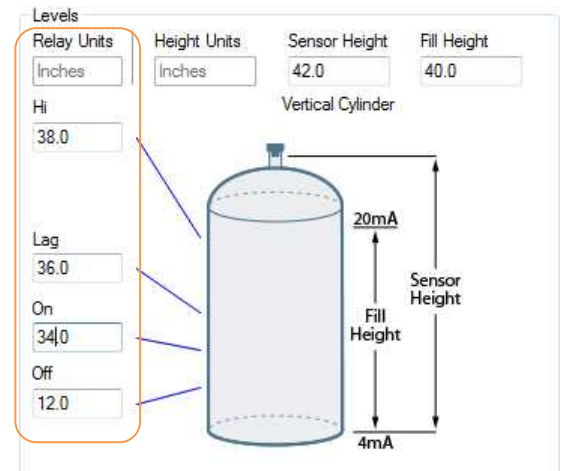

Pump Fill with High and Low Level Alarm:

This example features a single pump designed to automatically fill with both a high alarm and low level alarm. All values are configured in gallons (Relay Units shows Gallons).

- High – 185.0 gallons
- Off = 180.0 gallons
- On = 50.0 gallons
- Low = 40.0 gallons

Typically, the level is maintained between the ON and Off level for the automatic pump fill. If the level ever reaches the high level or falls below the low level, the respective relay will energize the alarms. Note: The total volume of the tank is shown under Capacity (located in lower left corner).

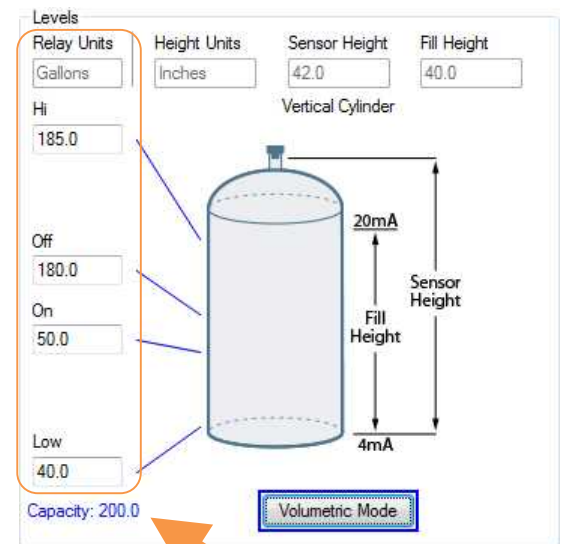

DL10, LU23, LU27, LU28 & LU29 series only: Verify the Height Units, Sensor Height, Fill-Height and Capacity. All values were calculated in the previous Dimensional Entry window. To adjust these settings, click on **Volumetric Modes**.

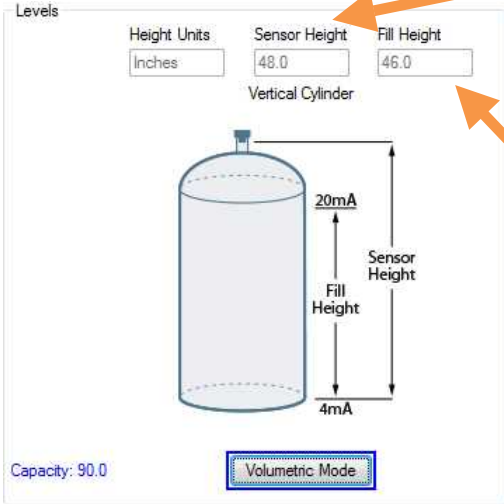

Sensor Height: Distance from the bottom of the tank (empty) to the bottom of the transducer (sensor).

Fill Height: Distance from the bottom of the tank to the maximum liquid height (full).

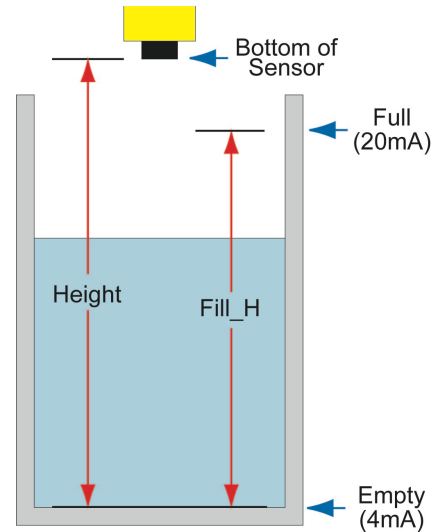

- For the DL10, LU23, LU27, LU28 and LU29 series, the Sensor Height and Fill Height values determine the operational range for the 4-20 mA output.

DL14, DL24, DL34 & DS14 series only: Verify the Relay Units, Height Units, Sensor Height, Fill-Height and Capacity as well as all of the Relay Settings. All values (except relay settings) were calculated in the previous Dimensional Entry window. To adjust these settings, click on **Volumetric Modes**.

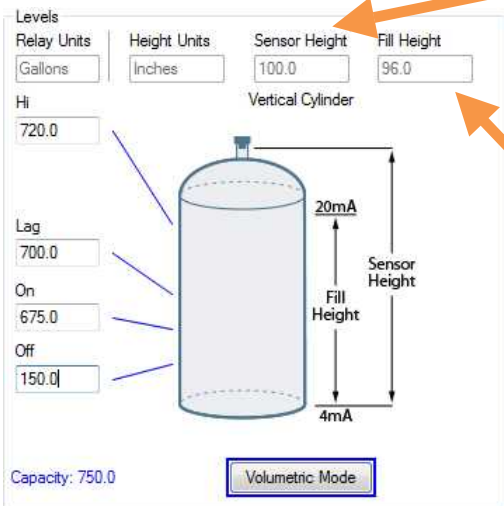

Sensor Height: Distance from the bottom of the tank (empty) to the bottom of the transducer (sensor).

Fill Height: Distance from the bottom of the tank to the maximum liquid height (full).

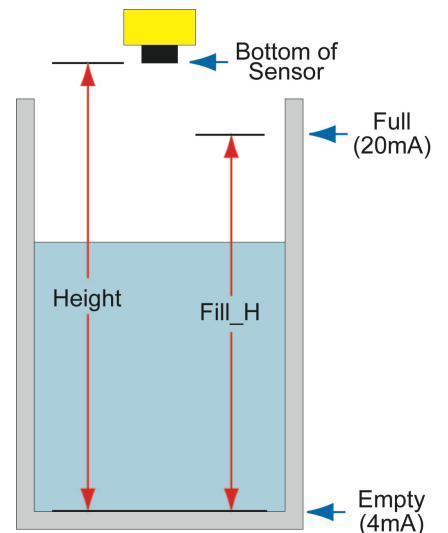

- For the DL14, DL24 and DL34 series, the Sensor Height and Fill Height values determine the operational range for the 4-20 mA output.
- There is no 4-20 mA output with the DS14 series.

DX10 & DX20 series only: Verify the Height Units, Sensor Height, Fill-Height and Capacity. All values were calculated in the previous Dimensional Entry window. To adjust these settings, click on **Volumetric Modes**.

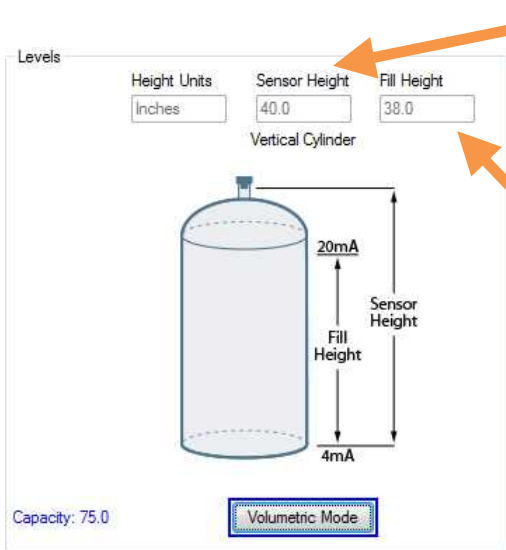

Sensor Height: Distance from the bottom of the tank (empty) to the bottom of the transducer (sensor).

Fill Height: Distance from the bottom of the tank to the maximum liquid height (full).

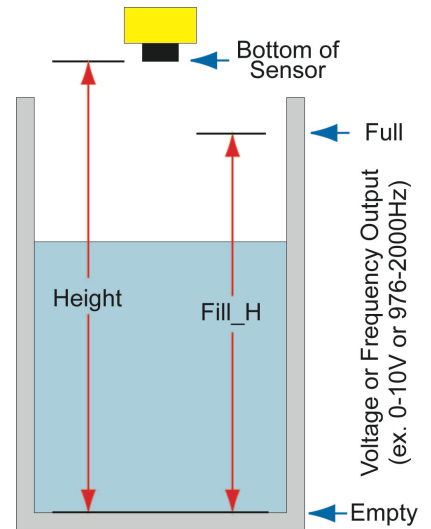

- For the DX10 & DX20 series, the Sensor Height and Fill Height values determine the operational range for the voltage or frequency output.

LG10 & LG11 series only: Verify the Height Units, Sensor Height, Probe Length, Maximum Fill-Height, Minimum Fill-Height and Capacity as well as the Max. / Min. Volume and Max. / Min. Current. All values were calculated in the previous Dimensional Entry window. To adjust these settings, click on **Volumetric Modes**.

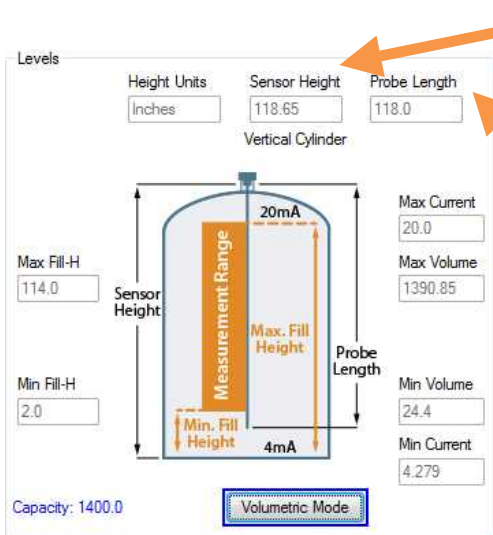

Sensor Height: Distance from the bottom of the tank to the top of the sensor threads.

Probe Length: Distance from the bottom of the threads to the end of the probe.

Max. Fill Height: Distance from the bottom of the tank to the maximum liquid height (full).

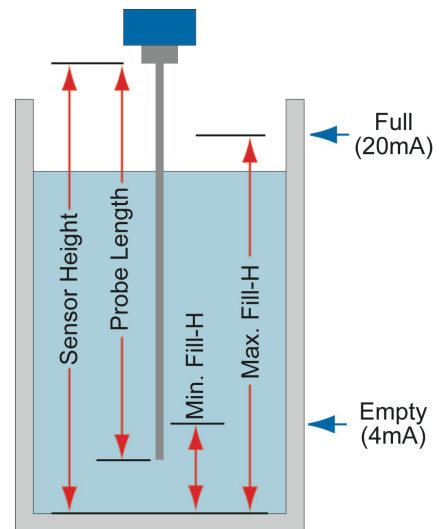

Min. Fill Height: Distance from the bottom of the tank to the minimum liquid height (empty).

- For the LG10 and LG11 series, the Sensor Height, Probe Length, Maximum Fill-Height and Minimum Fill-Height values determine the operational range for the 4-20 ma output.

Note: The location of 4mA for the LG10 and LG11 series is based upon the Minimum Fill Height. This value is dependent on the probe's distance above the bottom of the tank plus the lower dead band (2").

Write to Unit – After all values, settings and dimensions have been entered, the configuration still needs to be sent to the sensor. To transfer/upload the information to the sensor, click **“Write to Unit”**. When completed, this configuration will remain inside the sensor memory and will not change unless the sensor is connected to WebCal® and a new configuration is written to the sensor. Loss of power will not change or lose the configuration within sensor memory.

Next, use the file management features to save your configuration by clicking **“Save Config File”** and print your wiring diagram by clicking **“Wiring Diagram.”**

“Save Config File” will save this configuration as a text file which can be loaded back into WebCal® by pressing the **“Open Config File”** button. It is good practice to save the configuration file for each different configuration with a unique name for easy identification. If using multiple sensors in identical applications, then use of a single configuration file is recommended.

“Wiring Diagram” will display a PDF file showing the unique wiring for the specific configuration created in WebCal®. The PDF can be printed or emailed. It is good practice to save the wiring diagram as a backup.

Tech Tips:

- **4-20 mA Output Only:** If only the 4-20 mA output is required with a DL14, DL24 or DL34 (and no relays are used), under **Number of Pumps**, select **4-20mA Transmitter Only** to simplify the configuration.
- **Relay Set Points:** Never set relays set points at the extreme end of the operational range (empty or full). A relay requires the level to pass the set point before it switches. Example – If a low alarm is set to 0 gallons, it will never trigger because the level must pass below 0 gallons for it to activate. Best practice is to set the low alarm with a slight buffer.
- **Alarm Prevention:** Always set relay alarm set points where there is time to react to prevent an issue. Example – Setting an alarm where a tank overflows is not advisable. Best practice is to set a high level alarm where operators have plenty of time to prevent an overflow.

WIRING DIAGRAM – SAMPLE

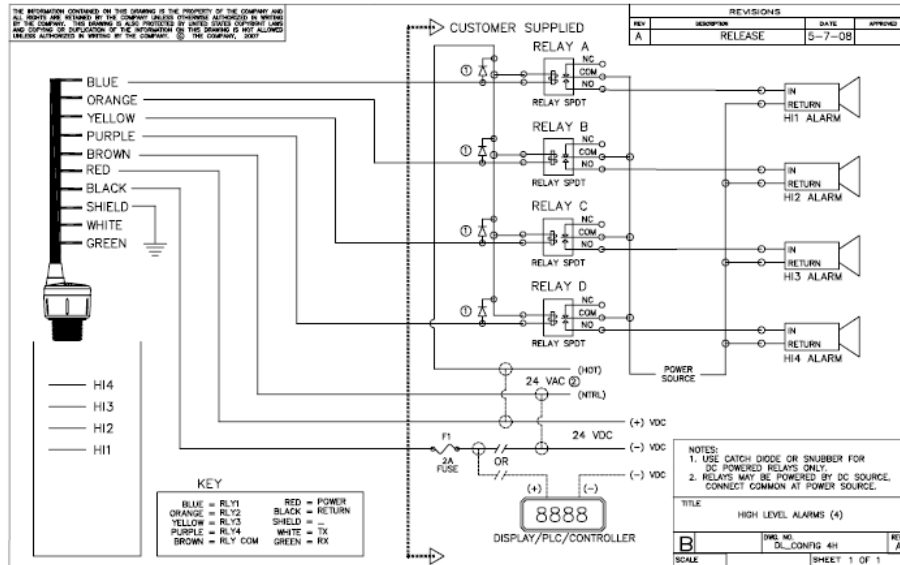

Diagrams change based upon each unique sensor configuration.

The diagram shown above is only a sample and should not be used as a wiring diagram.

Sensor Wiring: Once the sensor has been installed, follow the Wiring Diagram provided by the WebCal® software. A typical wiring diagram is shown above. Flowline recommends using a qualified licensed electrician to wire EchoPod®, EchoSonic® or EchoWave® with your application’s components.

- Configure your sensor with WebCal® and use the wiring diagram button to view the appropriate diagram. Each configuration will have its own unique diagram. The diagram shown above is only a sample and should not be used as a wiring diagram.
- Always use stepper relays between the sensor and external loads. For DC circuits, always use a catch diode such as 1N4148, shown on the Wiring diagram above supplied by WebCal®.
- Once the sensor is configured, isolate the white and green wires from active power to prevent a short of the configuration circuit.

General notes for electrical connections, usage and safety:

- Where personal safety or significant property damage can occur due to a spill, the installation must have a redundant backup safety system.
- Wiring should always be completed by a licensed electrician.
- Supply voltage should never exceed 28 VDC.
- Protect the sensor from excessive electrical spikes by isolating the power, whenever possible.
- The sensor materials must be chemically compatible with the liquids to be measured.
- Design a fail-safe system for possible sensor and/or power failure.
- Never use the sensor in environments classified as **hazardous**.

The advanced features settings are designed to help solve performance or operational issues for specific applications. Changing these setting will alter the factory default performance or operation, of your sensor. Please read through this HELP file to assist you in making adjustments or if you are still unclear about a specific issue, please contact FLOWLINE applications engineering.

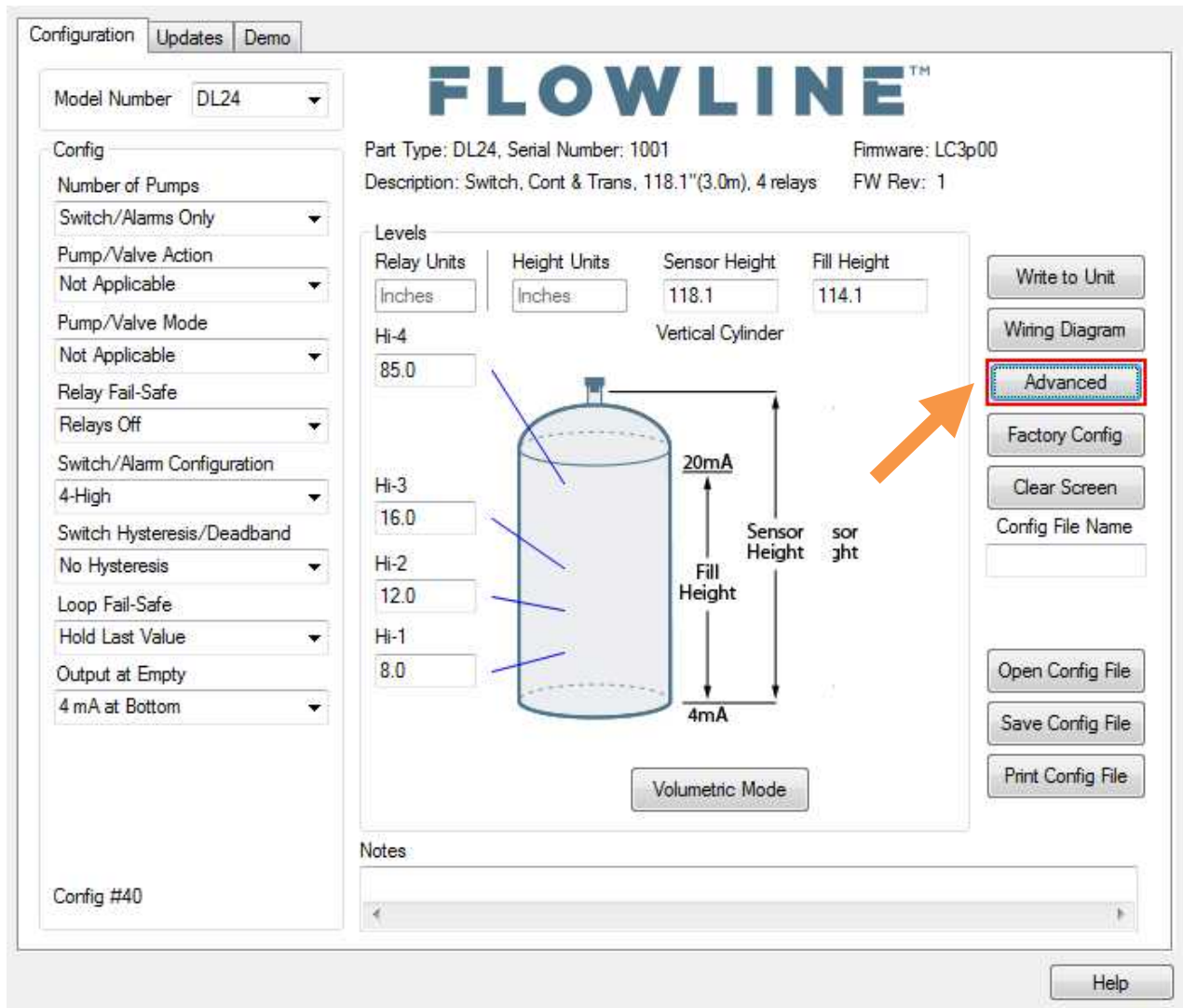

Note: When the Advanced Button is highlighted with a RED border, this indicates you have selected an advanced feature.

Additional Features, Invert Relay & Fail-Safe:

For DL10, DL24, DL34 and DS14 Series

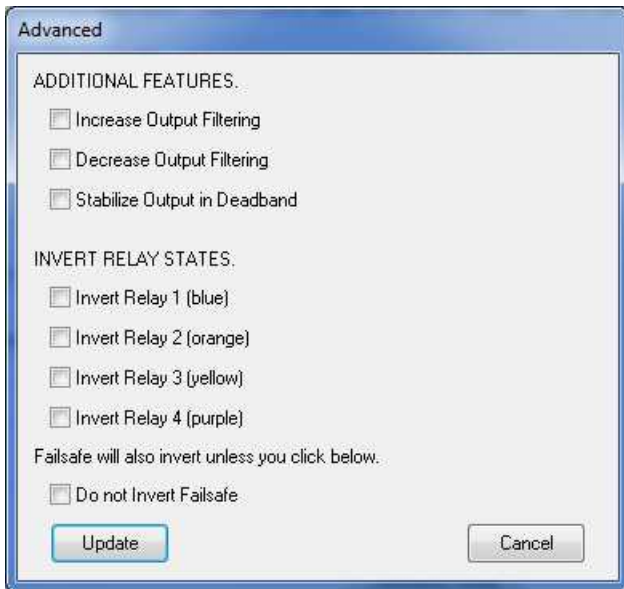

For DL10, DX10, DX20, LG10, LG11, LU23, LU27, LU28 & LU29 Series

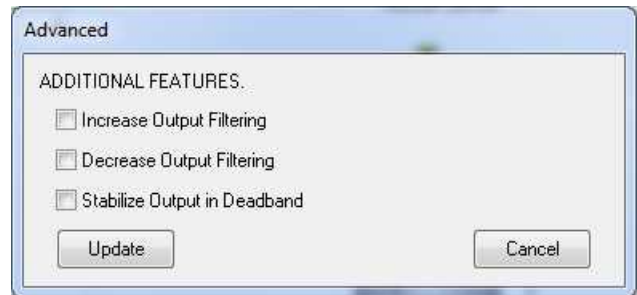

Note: Stabilize Output in Dead Band does not apply to the LG10 & LG11 Series.

- **Increase Output Filtering:** Placing a check mark in the box will increase the filtering (averaging) of the analog output. Use this filter if the 4 to 20 mA output requires a smoother output for the application such as open channel flow measurement.
- **Decrease Output Filtering:** Placing a check mark in the box will eliminate all filtering (averaging) of the analog output which enables a pulse by pulse level reading. Use this filter to see changes in level after every echo pulse.

Note: Never check increase output filtering and decrease output filtering at the same time.

- **Stabilize Output in Dead Band:** Placing a check mark in the box will activate a filter to hold the output at Full if the level enters the dead band of the EchoPod® and EchoSonic®. This filter requires the level to leave the dead band at a smooth and steady rate.
- **Invert Relay States:** Placing a check mark in any of the four boxes will reverse the state of that relay. For example, if relay 4 is a high alarm that energizes above 50.0” of liquid, checking the invert box will reverse its state so the relay will energize when the level is below 50” of liquid. Inverting the relay will also invert the fail-safe of the relay. If the relay is fail-safe On, inverting the relay will make it fail-safe Off.
- **Fail-Safe will also invert unless you check below:** Placing a check mark in the box will not invert the fail-safe when a relay is inverted.

SAMPLE PROGRAM

A sample version of WebCal® is available anytime a sensor is not attached to WebCal®. The Sample Program shows all the features in the Configuration Tab of WebCal®. Any configuration can be opened (Open Config File), Saved (Save Config File) or Printed (Print Config File) with the Sample Program. Sample Program cannot be viewed if a sensor is attached to the computer via the LI99-1001 Fob. To view the Sample Program, start WebCal® when a sensor is not attached to the computer. At the opening screen, select **Sample Program**.

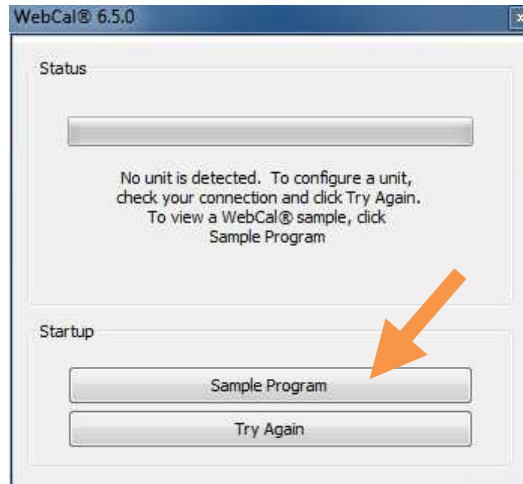

Select your model type in the upper right-hand corner. **Note:** When saving or opening a configuration, make sure the Model Number matches the sensors you intend to use.

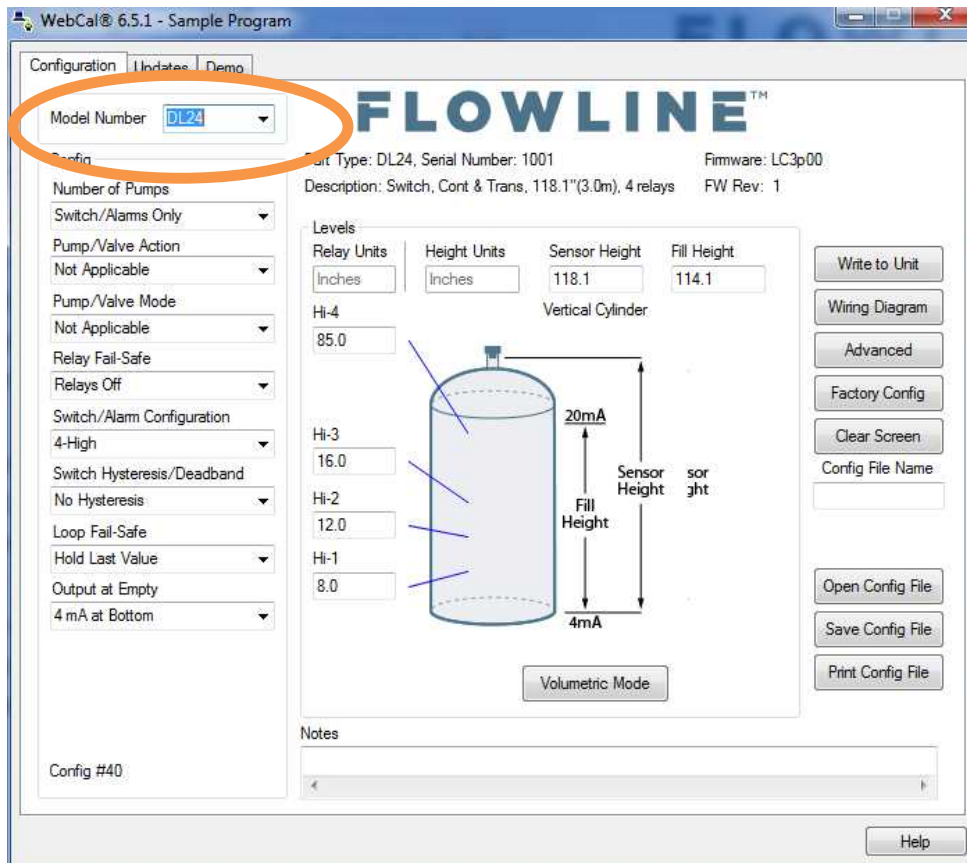

UPDATING WEBCAL® SOFTWARE

WebCal® can be updated directly from the software. Click on the **Updates** Tab at the top of the window and press the **Download** button. Make sure that your computer has access to the Internet. If not, an error window will appear.

Press the **Download** button and the software will check the version of software you are using with the most recent software version at Flowline. If the versions are the same, a window will open indicating that the most recent version is installed. If not, then a window will open asking you to download the latest version. Follow the instructions for installing the latest version.

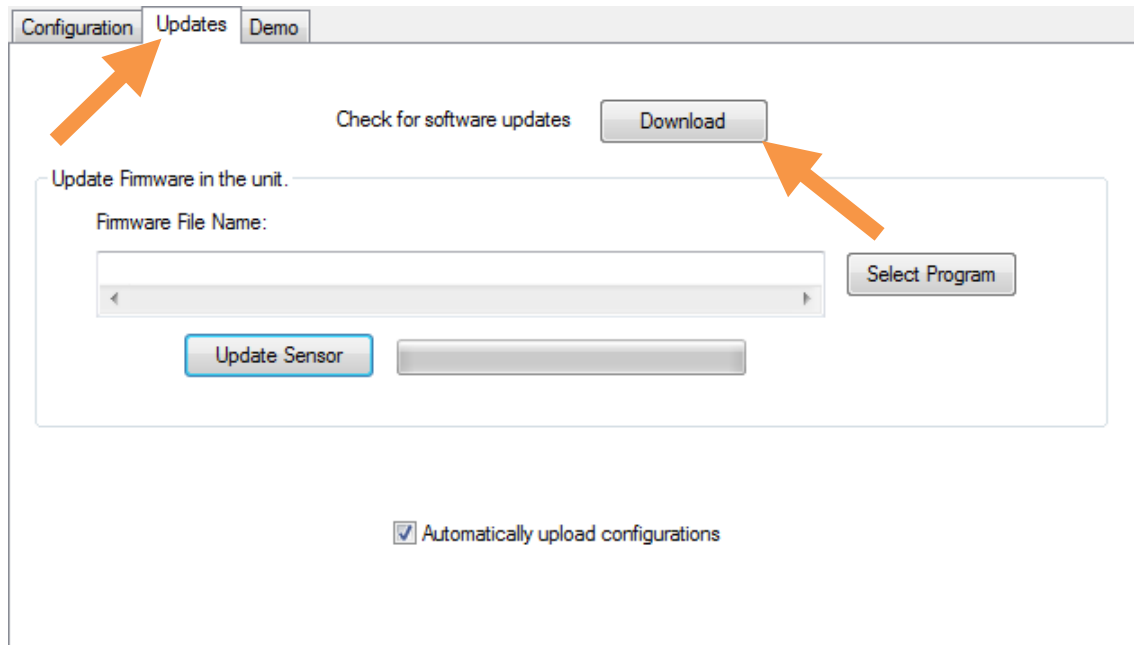

UPDATING SENSOR FIRMWARE

WebCal® can also be used to update the internal firmware for your sensor. The update will include the latest features and enhancements. To begin the update, open WebCal® with a sensor connected and the latest version of WebCal® installed on your computer.

- **When updating the sensor firmware, disconnect the sensor from all other devices including displays, controllers, power supplies, PLC's, pumps, valves and alarms. Connect the devices back after the firmware has been updated.**

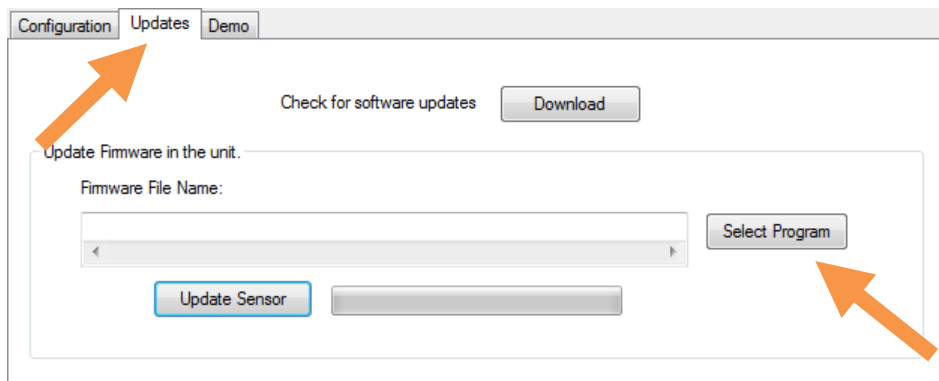

Click on the **Updates** Tab and then click on **Select Program** to select the firmware update.

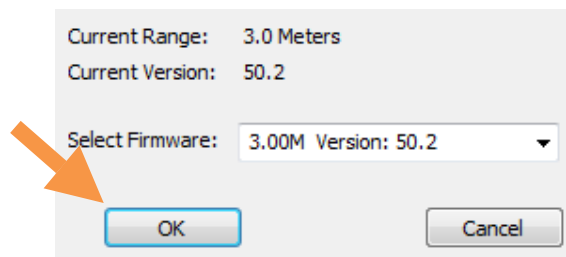

Select the latest version of the firmware file and click OK.

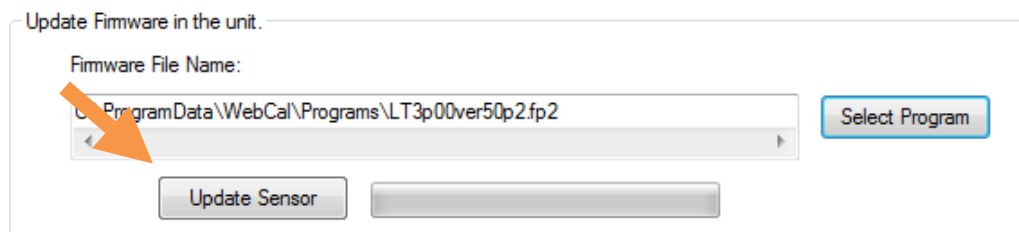

Confirm that the address is correct and then click on **Update Sensor** to begin the firmware update. This step should take less than 1 minute. You can follow the progress with the status bar to the right of the Update Sensor button. When completed, click on the Configuration tab to configure the sensor. **Note:** When the firmware has been updated, the unit will return to its original factory settings.

- If there is a communication interruption during the update, the process will stop. It is then OK to click on Update Sensor to start the process over again.

DEMO PAGE (DL10, DL14, DL24, DL24, DS14, DX10, DX20, LU23, LU27, LU28 & LU29 SERIES ONLY)

The Demo Page gives you the ability to test the sensors operation against a fixed target, including the confirmation of the switching points for the relays.

- The large top number shows the liquid level value in the units list just below to the right.
- The bottom smaller number shows the distance from the sensor face to the target in the same units.
 - Adding both numbers will equal the Sensor Height value.
- The Activity button will light every time the sensor pulses.
- The Relay buttons (Relay 1, 2, 3 & 4) will light when their corresponding relay is energized.
 - **Note:** This feature is only a simulation. The relays are not physically opening and closing.

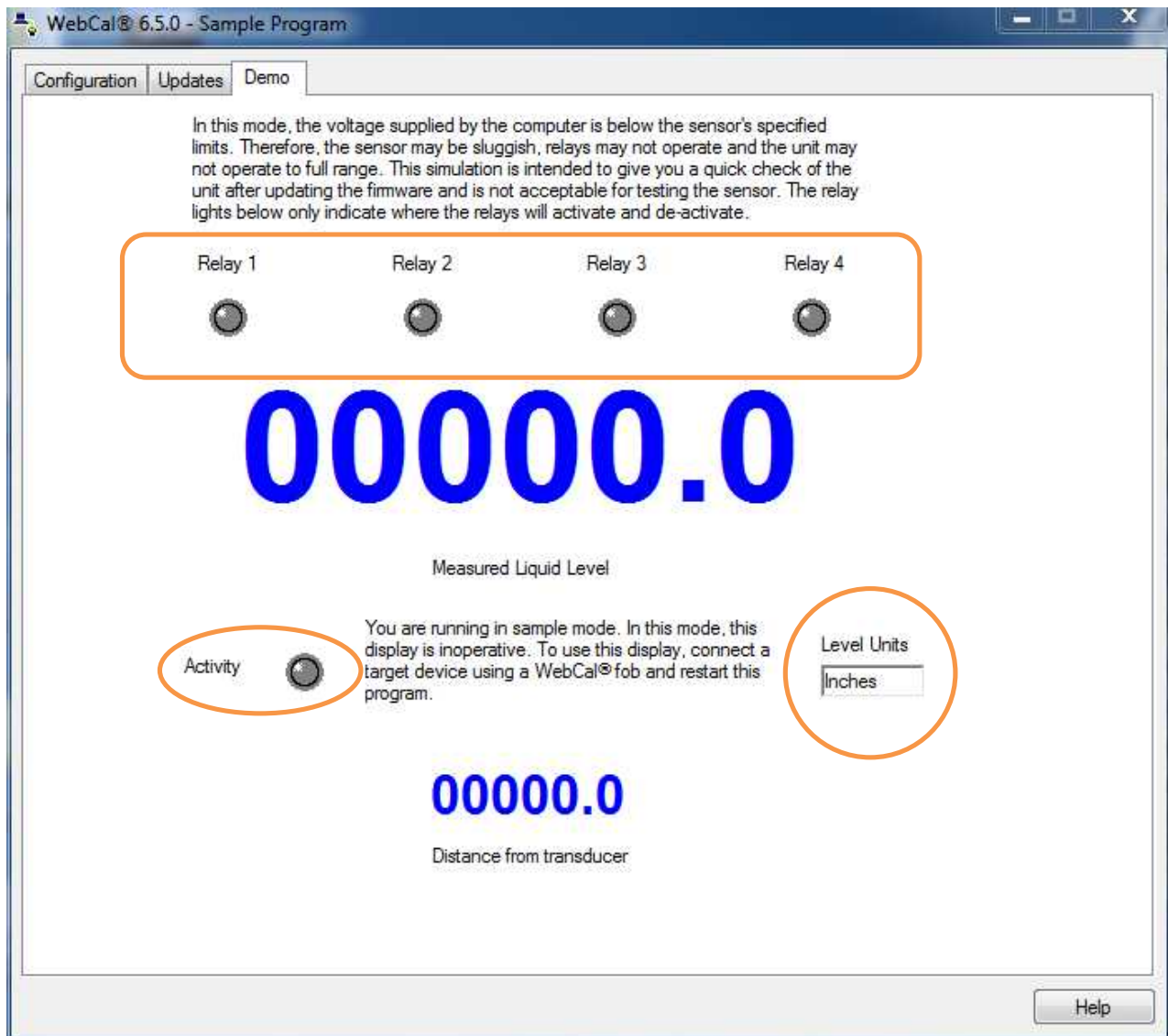

Note: In this mode, the voltage supplied by the computer is below the sensor's specified limits. Therefore, the sensor may be sluggish, relays may not operate and the unit may not operate to full range. This simulation is intended to give you a quick functional check after updating the firmware.

DIAGNOSTICS PAGE (FOR LG10 & LG11 SERIES ONLY)

The Diagnostics Page provides the ability to View the Empty Signal Scan and EchoCurve for the Guided Wave Radar sensors. **Note:** This feature does not work with any Ultrasonic sensor.

Viewing the Empty Signal Scan

The Empty Signal Scan can be viewed with the WebCal® software (version 6.5 and greater). **Note:** Always consult a Flowline® representative for reviewing of the signal data. To view, follow the directions below:

1. Activate an empty signal scan (see instruction manual for the LG10 & LG11 series sensor).
2. Connect EchoWave® to WebCal® software via Fob
3. Click on Diagnostics Tab on the main WebCal® screen
4. In the Select Signal Data pull down, select Empty Scan.
5. The empty signal scan will be displayed in the window.

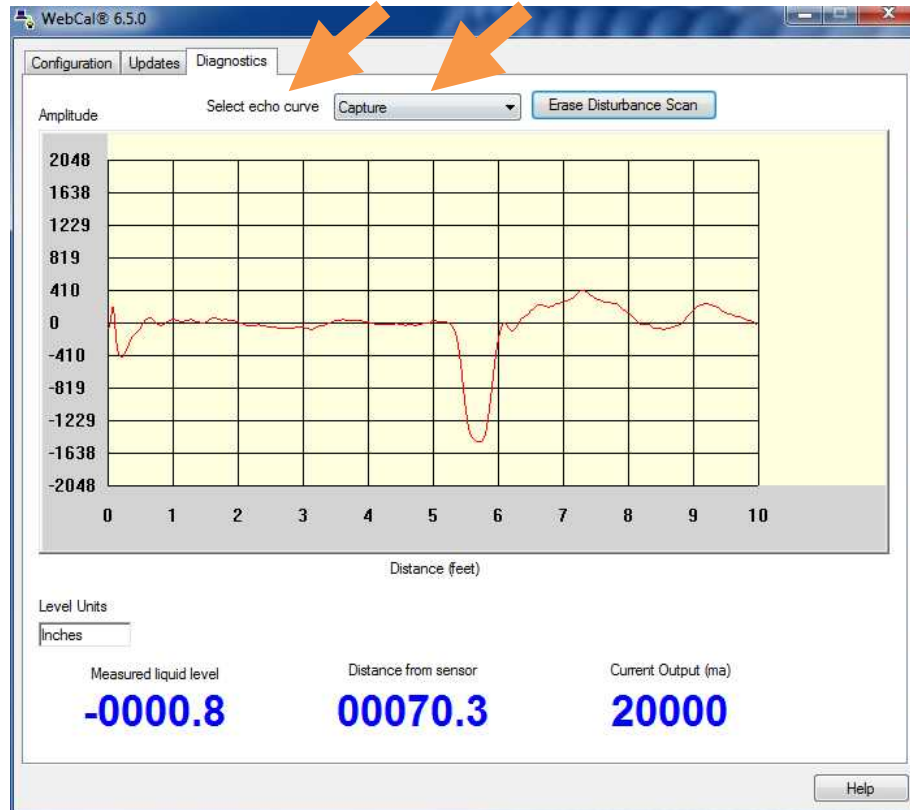
**Erase Empty Signal Scan with WebCal®**

If there is a need to erase or turn off the empty signal scan, perform the following:

1. Disconnect the sensor from the application wiring.
2. Connect EchoWave® to WebCal® software via Fob.
3. Click on Diagnostics Tab on the main WebCal® screen.
4. Click on Erase Empty Signal Scan.

Echo Curve

This function displays the primary echo return(s) that the sensor is seeing graphically as well as the location and amplitude of the return(s). It can be used to confirm the correct level reading by the sensor or to troubleshoot any false signals. There is a two step process involving the creating and viewing of an echo curve. **Note:** Always consult a Flowline® representative for reviewing of the signal data.

Create an Echo Curve

See instruction manual for the LG10 & LG11 series sensor

Viewing the Echo Curve

The echo curve(s) scan can be viewed with the WebCal® software (version 6.5 and greater). To view, follow the directions below:

1. Create an echo curve (see instructions above).
2. Connect EchoWave® to WebCal® software via Fob
3. Click on Diagnostics Tab on the main WebCal® screen
4. In the Select Signal Data pull down, select Echo Curve.
5. The echo curve will be displayed in the window.

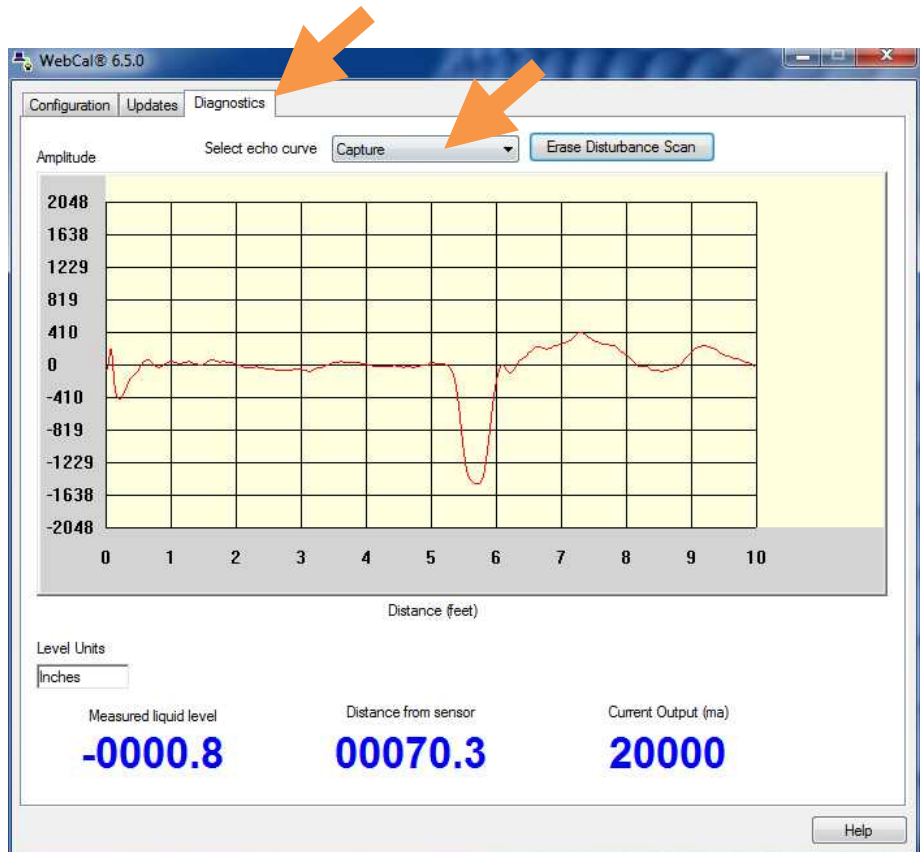

STRAPPING TABLE

WebCal® features a strapping table that enables you to enter up to 16 custom reference points instead of using the standard tank shapes. This feature is ideal for odd shaped tanks or tanks where specific levels are known volumes of liquid.

To access the Strapping Table, click on **Strapping Table** in the Shape Selection Window and press “OK”.

- Enter the Sensor Height, Fill Height, Riser Height and Tank Height. This information is used to configure the sensor to the tank.
- The Strapping Table also has two columns of 16 points for entering the known tank data.
- Select the dimensions and/or volume at the top of the two columns and enter the tank data.
- When done, press “Apply” to transfer the data and return to the Configuration window.

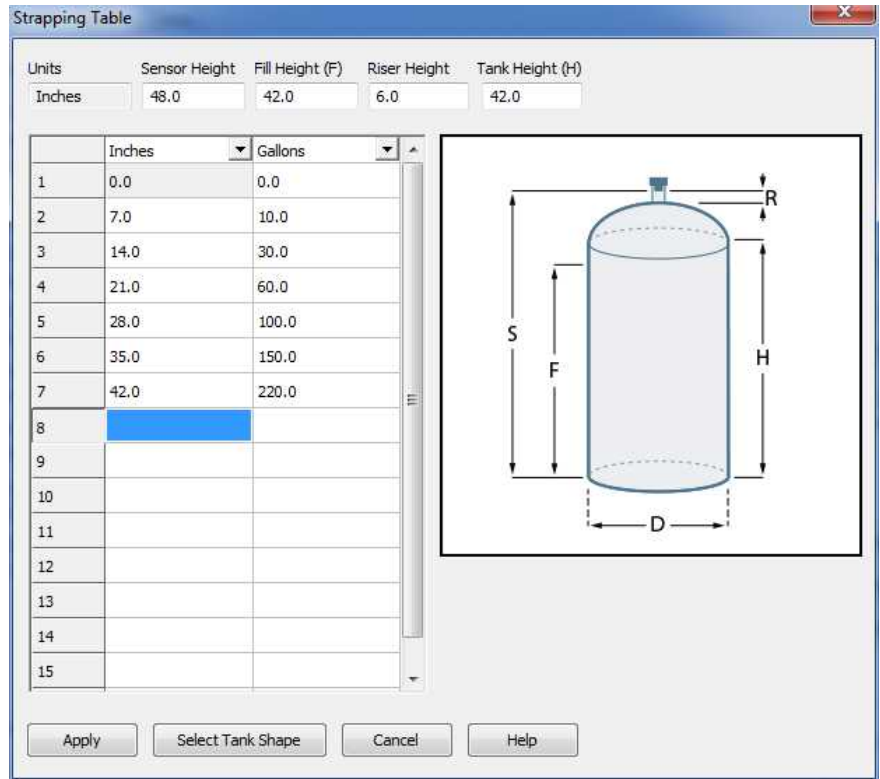

LINEAR VS. NON-LINEAR

Two of the shapes (Vertical Cylinder Tank and Rectangular Tank) will always provide a linear output, regardless of selecting Distance or Volume. The remaining four shapes (Vertical Cylinder Tank with Cone Bottom, Horizontal Cylinder Tank with End Caps, Horizontal Cylinder Tank with Spherical End Caps and Spherical Tank) will have a linear output when Distance is selected, but will have a non-linear output when volume is selected.

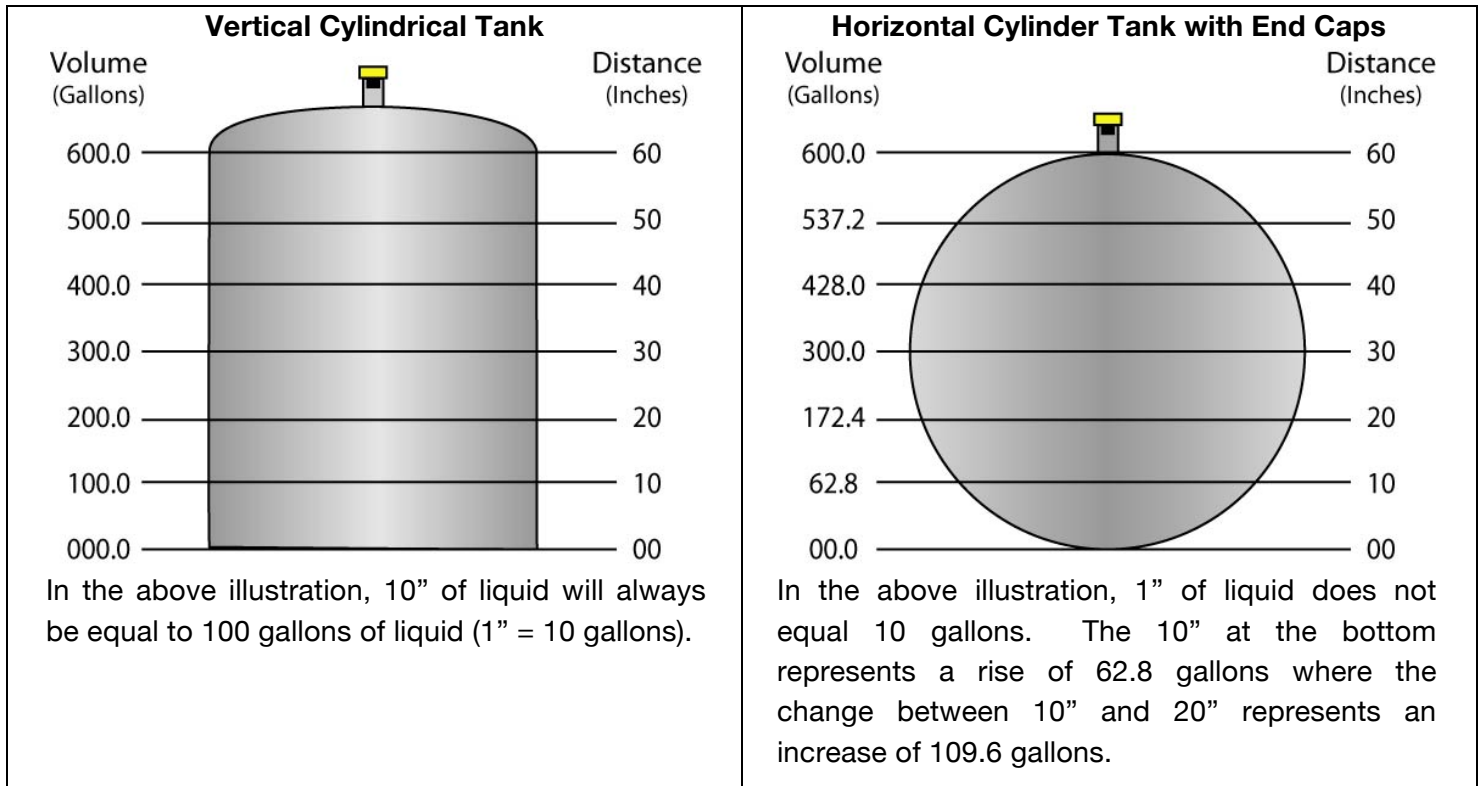

When volume is selected, the 4-20 mA output from the sensor will be proportional to the volume of the tank, not the height of the tank. This means that the current output will track the volume of the tank (in gallons or liters) within a non-linear tank (Vertical Cylinder Tank with Cone Bottom, Horizontal Cylinder Tank with End Caps, Horizontal Cylinder Tank with Spherical End Caps or Spherical Tank).

When connecting the signal output to a display, the signal will follow the volume of the tank. The display will also reflect the volume of the tank and not the height of the liquid.

Example #1 (Volume Output): in the above illustrations, @ 20" of liquid, the display will show 200.0 gallons in the Vertical Cylindrical Tank. However, in the Horizontal Cylinder Tank with End Caps, the same level of 20" would show 172.4 gallons.

Example #2 (Current Output): In the illustrations on the previous page, the 4mA signal is set at 0" (0.0 gallons) and the 20 mA signal is set to 60" (600.0 gallons). In the Vertical Cylindrical Tank, 40" of liquid will output a current signal of 14.67mA. However, in the Horizontal Cylindrical Tank with End Caps, 50" of liquid will output a current signal of 15.41mA. A simple loop display set with 4mA = 0 gallons and 20 mA = 600 gallons will show two different volumes based upon the tank shape configuration. Vertical Cylindrical Tank will show 400.0 gallons while Horizontal Cylindrical Tank with End Caps will show 428.0 gallons.

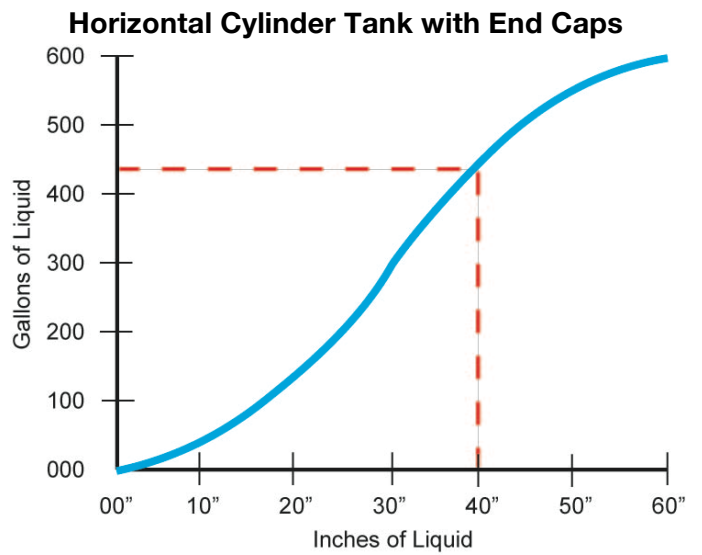
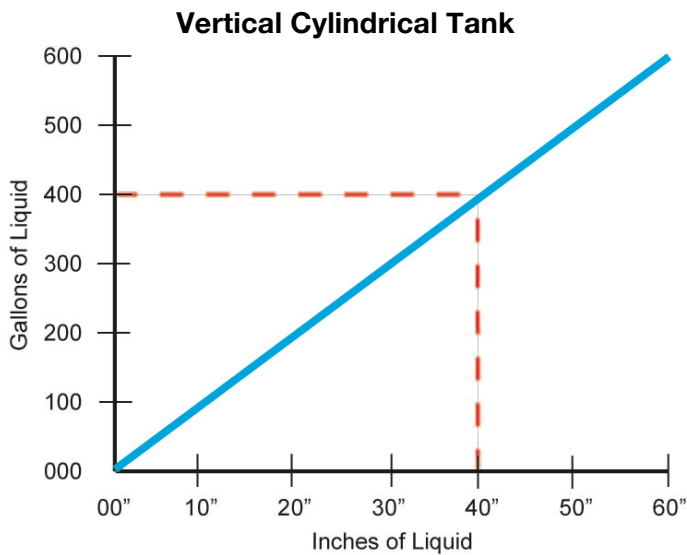

In the above illustration, 10" of liquid will always be equal to 100 gallons of liquid (1" = 10 gallons).

In the above illustration, 1" of liquid does not equal 10 gallons. The 10" at the bottom represents a rise of 62.8 gallons where the change between 10" and 20" represents an increase of 109.6 gallons.

TROUBLESHOOTING

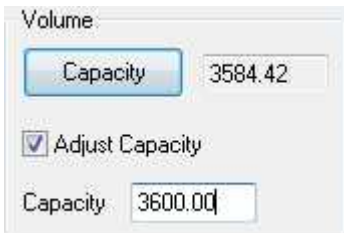
PROBLEM	SOLUTION
<p>No Unit Detected in WebCal®.</p>	<p>WebCal® cannot detect an EchoPod®, EchoSonic® or EchoWave® connected to the computer.</p> <ul style="list-style-type: none"> • Check that the Fob is connected to the USB® port. • Check that all four wires (Red, Black, White and Green) are securely attached to the Fob. • Check Device Manager and confirm that both drivers (WebCal® Configuration & EchoFob) are present. • Make sure the cable length between the computer and the sensor is less than 15' (4.57m)
<p>Drivers not found or missing. Also, USB® Fob (LI99-1001) was plugged into computer before WebCal® software was installed.</p>	<p>WebCal® cannot detect the driver for the USB® Fob (LI99-1001) or an incorrect driver was installed. To correct this, install WebCal® software while in safe mode. To access safe mode, press and hold F8 during computer boot up. Once in safe mode, install the WebCal® software. Test software while in safe mode. When done, re-boot computer to return to normal operation. WebCal® will be operational as well.</p>
<p>Internet error. The server name or address could not be resolved.</p>	<p>This is a warning indicating that the computer configuring EchoPod®, EchoSonic® or EchoWave® is not connected to the Internet. Click OK to continue. Flowline® recommends being connecting to the Internet during configuration. Not being connected to the Internet will not prevent EchoPod®, EchoSonic® or EchoWave® from being configured.</p> <p>To turn off this warning, go to the Updates Tab and click on the check box “Automatically upload configurations”. Click on NO in the new window and the previous check box will become unchecked. WebCal® will no longer attempt to connect to the internet. Clicking on the check box will restore this feature.</p>
<p>Cannot access some of the configuration features in WebCal®.</p>	<p>As choices are made in Configuration, WebCal® will begin to eliminate functions that are not applicable to a configuration. To reset Configuration or get access to all the features, click on the Clear Screen button.</p>
<p>Capacity will not change regardless of changes to dimension.</p>	<p>As long as the Adjust Capacity box is checked, the Capacity cannot be changed. Simple uncheck the box and press Capacity to view the calculated tank capacity.</p> 

WARRANTY

Flowline warrants to the original purchaser of its products that such products will be free from defects in material and workmanship under normal use and service in accordance with instructions furnished by Flowline for a period of two years from the date of manufacture of such products. Flowline's obligation under this warranty is solely and exclusively limited to the repair or replacement, at Flowline's option, of the products or components, which Flowline's examination determines to its satisfaction to be defective in material or workmanship within the warranty period. Flowline must be notified pursuant to the instructions below of any claim under this warranty within thirty (30) days of any claimed lack of conformity of the product. Any product repaired under this warranty will be warranted only for the remainder of the original warranty period. Any product provided as a replacement under this warranty will be warranted for the full two years from the date of manufacture.

RETURNS

Products cannot be returned to Flowline without Flowline's prior authorization. To return a product that is thought to be defective, go to www.flowline.com, and submit a customer return (MRA) request form and follow the instructions therein. All warranty and non-warranty product returns to Flowline must be shipped prepaid and insured. Flowline will not be responsible for any products lost or damaged in shipment.

LIMITATIONS

This warranty does not apply to products which: 1) are beyond the warranty period or are products for which the original purchaser does not follow the warranty procedures outlined above; 2) have been subjected to electrical, mechanical or chemical damage due to improper, accidental or negligent use; 3) have been modified or altered; 4) anyone other than service personnel authorized by Flowline have attempted to repair; 5) have been involved in accidents or natural disasters; or 6) are damaged during return shipment to Flowline. Flowline reserves the right to unilaterally waive this warranty and dispose of any product returned to Flowline where: 1) there is evidence of a potentially hazardous material present with the product; or 2) the product has remained unclaimed at Flowline for more than 30 days after Flowline has dutifully requested disposition. This warranty contains the sole express warranty made by Flowline in connection with its products. ALL IMPLIED WARRANTIES, INCLUDING WITHOUT LIMITATION, THE WARRANTIES OF MERCHANTABILITY AND FITNESS FOR A PARTICULAR PURPOSE, ARE EXPRESSLY DISCLAIMED. The remedies of repair or replacement as stated above are the exclusive remedies for the breach of this warranty. IN NO EVENT SHALL FLOWLINE BE LIABLE FOR ANY INCIDENTAL OR CONSEQUENTIAL DAMAGES OF ANY KIND INCLUDING PERSONAL OR REAL PROPERTY OR FOR INJURY TO ANY PERSON. THIS WARRANTY CONSTITUTES THE FINAL, COMPLETE AND EXCLUSIVE STATEMENT OF WARRANTY TERMS AND NO PERSON IS AUTHORIZED TO MAKE ANY OTHER WARRANTIES OR REPRESENTATIONS ON BEHALF OF FLOWLINE. This warranty will be interpreted pursuant to the laws of the State of California. If any portion of this warranty is held to be invalid or unenforceable for any reason, such finding will not invalidate any other provision of this warranty.

For complete product documentation and technical support, go to flowline.com. For phone support, call 562-598-3015 from 8am to 5pm PST, Monday-Friday. Please have the Part and Serial number available.