

Warranty, Service & Repair

To register your product with the manufacturer, fill out the enclosed warranty card and return it immediately to:

Flowline Inc.
10500 Humbolt Street
Los Alamitos, CA 90720.

If for some reason your product must be returned for factory service, contact Flowline Inc. to receive a Material Return Authorization number (MRA) first, providing the following information:

1. Part Number, Serial Number
2. Name and telephone number of someone who can answer technical questions related to the product and its application.
3. Return Shipping Address
4. Brief Description of the Symptom
5. Brief Description of the Application

Once you have received a Material Return Authorization number, ship the product prepaid in its original packing to:

Flowline Factory Service
MRA _____
10500 Humbolt Street
Los Alamitos, CA 90720

To avoid delays in processing your repair, write the MRA on the shipping label. Please include the information about the malfunction with your product. This information enables our service technicians to process your repair order as quickly as possible.

FLOWLINE®

Continuous Relay Controller LC52 Series Owner's Manual



Version 4.2

© 2005 FLOWLINE Inc.

All rights reserved.

Manual # LC900007

05/05

WARRANTY

Flowline warrants to the original purchaser of its products that such products will be free from defects in material and workmanship under normal use and service for a period which is equal to the shorter of one year from the date of purchase of such products or two years from the date of manufacture of such products.

This warranty covers only those components of the products which are non-moving and not subject to normal wear. Moreover, products which are modified or altered, and electrical cables which are cut to length during installation are not covered by this warranty.

FLOWLINE's obligation under this warranty is solely and exclusively limited to the repair or replacement, at FLOWLINE's option, of the products (or components thereof) which FLOWLINE's examination proves to its satisfaction to be defective. FLOWLINE SHALL HAVE NO OBLIGATION FOR CONSEQUENTIAL DAMAGES TO PERSONAL OR REAL PROPERTY, OR FOR INJURY TO ANY PERSON.

This warranty does not apply to products which have been subject to electrical or chemical damage due to improper use, accident, negligence, abuse or misuse. Abuse shall be assumed when indicated by electrical damage to relays, reed switches or other components. The warranty does not apply to products which are damaged during shipment back to FLOWLINE's factory or designated service center or are returned without the original casing on the products. Moreover, this warranty becomes immediately null and void if anyone other than service personnel authorized by Flowline attempts to repair the defective products.

Products which are thought to be defective must be shipped prepaid and insured to FLOWLINE's factory or a designated service center (the identity and address of which will be provided upon request) within 30 days of the discovery of the defect. Such defective products must be accompanied by proof of the date of purchase.

Flowline further reserves the right to unilaterally waive this warranty and to dispose of any product returned to Flowline where:

- a. There is evidence of a potentially hazardous material present with product.
- b. The product has remained unclaimed at Flowline for longer than 30 days after dutifully requesting disposition of the product.

THERE ARE NO WARRANTIES WHICH EXTEND BEYOND THE DESCRIPTION ON THE FACE OF THIS WARRANTY. This warranty and the obligations and liabilities of Flowline under it are exclusive and instead of, and the original purchaser hereby waives, all other remedies, warranties, guarantees or liabilities, express or implied. EXCLUDED FROM THIS WARRANTY IS THE IMPLIED WARRANTY OF FITNESS OF THE PRODUCTS FOR A PARTICULAR PURPOSE OR USE AND THE IMPLIED WARRANTY OF MERCHANT ABILITY OF THE PRODUCTS.

This warranty may not be extended, altered or varied except by a written instrument signed by a duly-authorized officer of Flowline, Inc.

SPECIFICATIONS

Step One

Supply voltage: 120 VAC (240 VAC), 50 - 60 Hz.
 Consumption: 5 Watt
 Sensor input: (1) Transmitter
 Sensor supply: 24 VDC @ 1.5 Watts
 Loop power: 4-20 mA, 18 VDC
 Set point adjustment: Push button
 Configuration: 1: High or low level alarm
 2: High and low level alarm
 3: Automatic fill or empty
 4: Automatic fill or empty with alarm

LED display: Alphanumeric, 3.5 digit
 LED indicators: Power and relay status
 Bar graph display: 4-20 mA with set points
 Alarm indication: Amber: < 4 mA
 Red: > 20 mA

Security: Lock out mode
 Relay types: (1) SPDT
 (1) Latched SPDT
 Relay rating: 250 VAC, 10A, 1/2 hp.
 Relay mode: Selectable, NO or NC
 Relay latch: ON or OFF
 Time delay: 0-60 seconds
 Repeater output: 4-20 mA, 12-36 VDC
 Fail safety: Power fail-safe
 Temperature range: F: -40° to 158°
 C: -40° to 70°

Enclosure mounting: 35 mm DIN (EN 50 022)
 Enclosure material: Polypropylene
 (U.L. 94 VO)

CE Compliance: EN 50082-2 immunity
 EN 55011 emission
 EN 61010-1 Safety

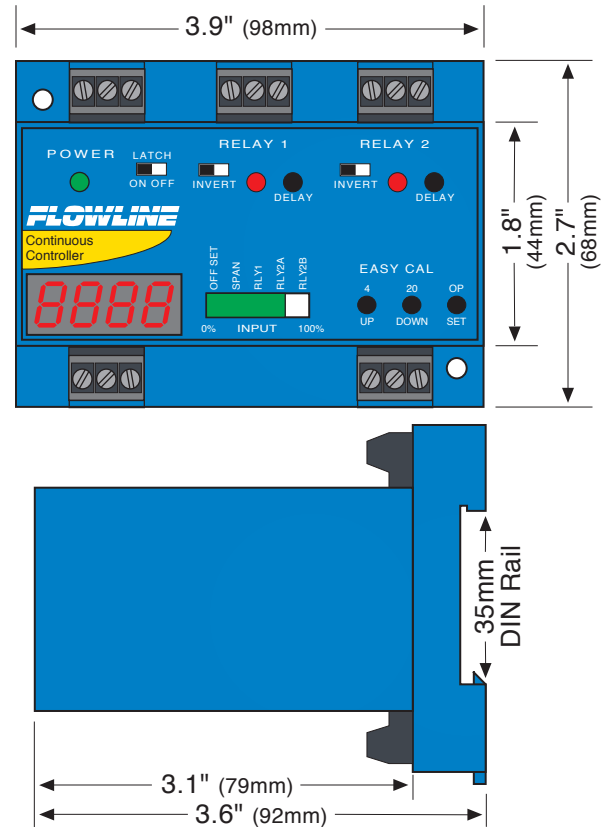

Internal Wiring Logic

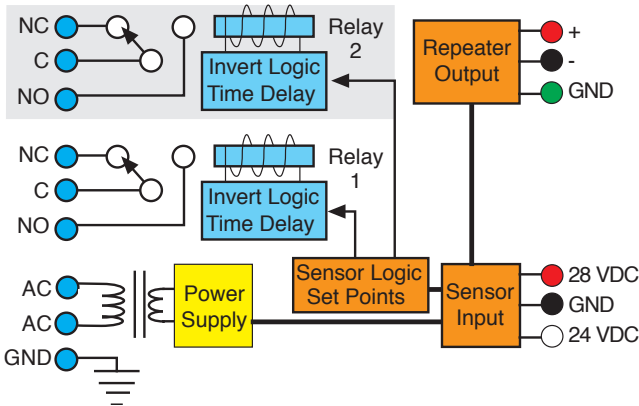

Relay Logic Table:

Relay 2 can either be a independent relay similar to relay 1 or can be a latching relay with latch ON. With Latch Off, relay 2 will only respond to the RLY2A setting. RLY2B will be ignored.

Invert OFF		Latch OFF	
RLY 2A	RLY 2B	Relay	
ON	No Effect	ON	
OFF	No Effect	OFF	

Invert ON		Latch OFF	
RLY 2A	RLY 2B	Relay	
ON	No Effect	OFF	
OFF	No Effect	ON	

With Latch ON, relay 2 will actuate when RLY2A and RLY2B are in the same condition. The relay will not change its condition until both inputs reverse their state.

Invert OFF		Latch ON	
RLY 2A	RLY 2B	Relay	
ON	ON	ON	
OFF	ON	No Change	
ON	OFF	No Change	
OFF	OFF	OFF	

Invert ON		Latch ON	
RLY 2A	RLY 2B	Relay	
ON	ON	OFF	
OFF	ON	No Change	
ON	OFF	No Change	
OFF	OFF	ON	

SAFETY PRECAUTIONS

Step Two

⚠ About This Manual:

PLEASE READ THE ENTIRE MANUAL PRIOR TO INSTALLING OR USING THIS PRODUCT. This manual includes information on the Continuous Relay Controllers from Flowline: LC52-1001.

⚠ User's Responsibility for Safety:

Flowline manufactures several models of controller, with different mounting and switching configurations. It is the user's responsibility to select a controller model that is appropriate for the application, install it properly, perform tests of the installed system, and maintain all components.

⚠ Electrical Shock Hazard:

It is possible to contact components on the controller that carry high voltage, causing serious injury or death. All power to the controller and the relay circuit(s) it controls should be turned OFF prior to working on the controller. If it is necessary to make adjustments during powered operation, use extreme caution and use only insulated tools. Making adjustments to powered controllers is not recommended.

⚠ Flammable or Explosive Applications:

LC52 series remote mount controllers should not be used with explosive or flammable liquids, which require an intrinsically safe rating. If you are unsure of the suitability of a controller for your installation, consult your Flowline representative for further information.

⚠ Install In a Dry Location:

The controller housing is not designed to be immersed. It should be mounted in such a way that it does not come into contact with liquid. Its case is made out of PP (polypropylene). Refer to an industry reference to ensure that compounds that may splash onto the controller housing will not damage it. Such damage is not covered by the warranty.

⚠ Relay Contact Rating:

The relay is rated for a 10 amp resistive load. Many loads (such as a motor during start-up or incandescent lights) are reactive and have an inrush current characteristic that may be 10 to 20 times their steady-state load rating. The use of a contact protection circuit may be necessary for your installation if the 10 amp rating does not provide an ample margin for such inrush currents. In critical applications, redundant backup systems and alarms must be used in addition to the primary system. Such backup systems should use different sensor technologies where possible.

⚠ Make a Fail-Safe System:

Design a fail-safe system that accommodates the possibility of relay or power failure. If power is cut off to the controller, it will de-energize the relay. Make sure that the de-energized state of the relay is the safe state in your process. For example, if controller power is lost, a pump filling a tank will turn off if it is connected to the Normally Open side of the relay.

While the internal relay is reliable, over the course of time relay failure is possible in two modes: under a heavy load the contacts may be "welded" or stuck into the energized position, or corrosion may build up on a contact so that it will not complete the circuit when it should. In critical applications, redundant backup systems and alarms must be used in addition to the primary system. Such backup systems should use different sensor technologies where possible.

While this manual offers some examples and suggestions to help explain the operation of Flowline products, such examples are for information only and are not intended as a complete guide to installing any specific system.

GUIDE TO CONTROLS

Step Three

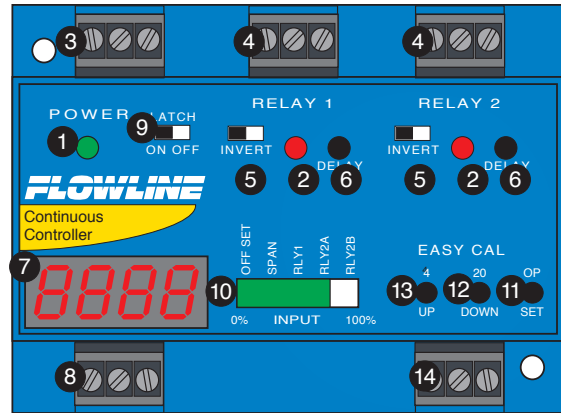

- 1. Power indicator:** This Green LED lights when AC power is ON.
- 2. Relay indicator:** This Red LED will light whenever the controller energizes the relay, in response to the transmitter input and after the time delay.
- 3. AC Power terminals:** Connection of 120 VAC power to the controller. The setting may be changed to 240 VAC if desired. This requires changing internal jumpers; this is covered in the Installation section of the manual. Polarity (neutral and hot) does not matter.
- 4. Relay terminals (NC, C, NO):** Connect the device you wish to control (pump, alarm etc.) to these terminals: supply to the COM terminal, and the device to the NO or NC terminal as required. The switched device should be a non-inductive load of not more than 10 amps; for reactive loads the current must be derated or protection circuits used. When the red LED is ON and the relay is in the energized state, the NO terminal will be closed and the NC terminal will be open.
- 5. Invert switch:** This switch reverses the logic of the relay control in response to the switch(es): conditions that used to energize the relay will now de-energize the relay and vice versa.
- 6. Time delay:** Sets delay from 0 to 60 seconds. Hold Delay button to increase delay in 5 second increments.
- 7. Digital display:** Shows the current 4-20 mA signal in engineering units.
- 8. Input terminals:** Connect the transmitter wires to these terminals: A 24 VDC power is provided for current loop with an additional 28 VDC power terminal if required.
- 9. Latch switch (relay 2):** This switch determines how the relay will be energized in response to the two set points. When LATCH is OFF, the relay responds to set point RLY2A only; when LATCH is ON, the relay will energize or de-energize only when both set points (RLY2A and RLY2B) are in the same condition (both wet or both dry). The relay will remain latched until both set points change conditions.
- 10. Bar Graph:** Displays 4-20 mA signal as a percentage of the range.
- 11. OP / SET:** Used to scroll between set points during programming.
- 12. 20 / Down:** Used to decrease display value during programming and for EasyCal™ Span set up.
- 13. 4 / Up:** Used to increase display value during programming and for EasyCal™ Offset set up.
- 14. Repeater Output:** Isolated terminal which reproduces the input 4-20 mA signal. Terminal requires 12-36 VDC power for operation.

INSTALLATION

Step Four

Panel DIN Rail Mounting

The controller may be mounted by either a back panel using two screws through mounting holes located at the corners of the controller or by snapping the controller on 35 mm DIN Rail.

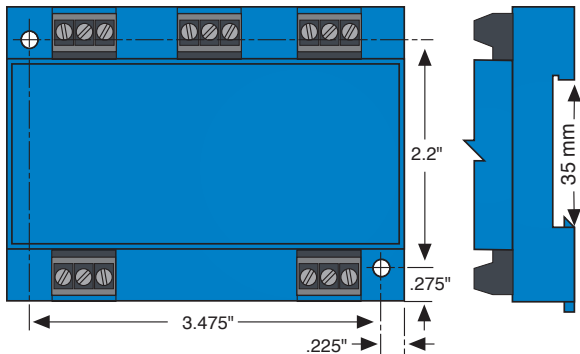

Note: Always install the controller in a location where it does not come into contact with liquid.

Setting Input Polarity:

The LC52 can be set in one of two modes, sourcing and sinking. The LC52 is shipped from the factory in the sourcing mode. This is compatible with the LA12-0_1, LA15-50_1, LP75-20_1, LU20-50_1, LU30-50_4 and LU35-50_4 with no adjustment required. If using a LU30-50_3, LU35-50_3 and LU20-50_1-IS, follow the instructions below.

1. Remove the back panel of the controller and gently slide the printed circuit board (PCB) from the housing. Use caution when removing the PCB.
2. Locate jumpers JWA and JWB on the PCB.
3. To change from sourcing to sinking, remove jumper from JWA and place on JWB. The LC52 is shipped from the factory in the sourcing mode (JWA active).
4. Gently return PCB into housing and replace back panel.

Note: Loop powered devices can operate in either the sourcing or sinking modes. Please see step 4 for proper wiring instructions.

Changing from 120 to 240 VAC:

Sourcing Mode

Sinking Mode



No Change Required	LU30-50_4, LU50-70_4, LU20-50_1, LU05-5_1, LU1_-5_1, LU8_-51_1, LV5_-S001 & LD1_-S001	Sinking or Loop Devices
Change Required	LU30-50_3, LU50-70_3 & LU20-50_1-IS	Sourcing Device

1. Remove the back panel of the controller and gently slide the printed circuit board from the housing. Use caution when removing the PCB.
2. Located jumpers JW1, JW2 and JW3 on the PCB.
3. To change to 240 VAC, remove jumpers from JW1 and JW2 and place a single jumper across JW3. To change to 120 VAC, remove jumper JW3 and place jumpers across JW1 and JW2.
4. Gently return PCB into housing and replace back panel.

120 VAC

240 VAC



WIRING

Step Five

Wiring to Input Terminals

Signal input is always through the 24 VDC terminal. The 28 VDC terminal is used as an alternative power supply for three-wire devices. Please note a difference between 2-wire and 3-wire level transmitters and sourcing and sinking modes below.

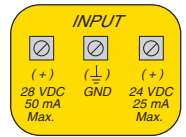

Two-wire Transmitter (Sourcing Mode / JWA)

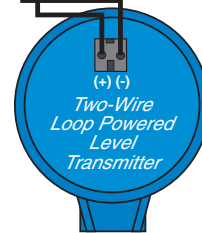
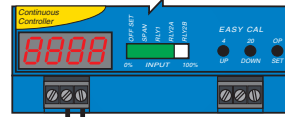

Two-wire Transmitter (Sinking Mode / JWB)

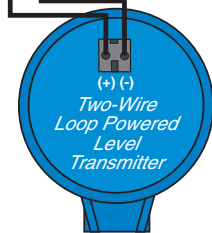
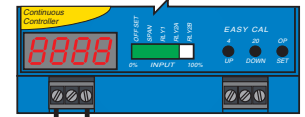

Three-wire Transmitter (Sourcing Mode / JWA)

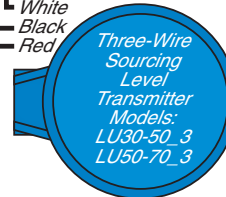
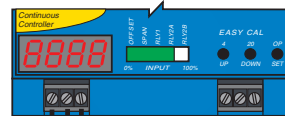

Three-wire Transmitter (Sinking Mode / JWB)

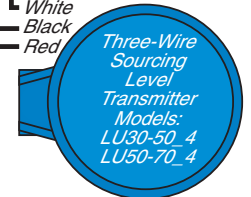
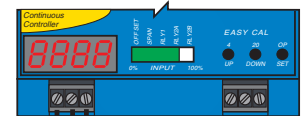

Intrinsically Safe Two-wire Transmitter LU20-5001-IS (Sinking Mode / JWB)

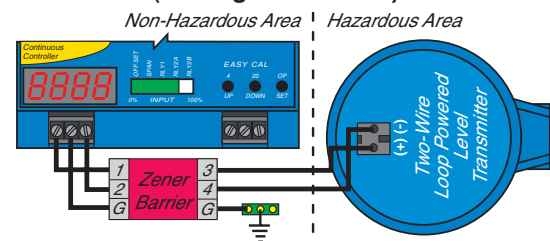

LB10-1001
Stahl Barrier
9001/51-280-110-14
 $V_{oc} = 28.0 \text{ V}$
 $I_{sc} = 105.9 \text{ mA}$
 $C_a = 0.14 \mu\text{F}$
 $L_a = 3.2 \text{ mH}$

LU20-5001-IS
Intrinsically Safe
Level Transmitter
 $V_{max} = 32 \text{ V}$
 $I_{max} = 130 \text{ mA}$
 $C_a = 0 \mu\text{H}$
 $L_a = 0 \text{ mH}$

Repeater Output:

The isolated repeater output reproduces the input current signal. External power is required and should not exceed a maximum of 36 VDC.

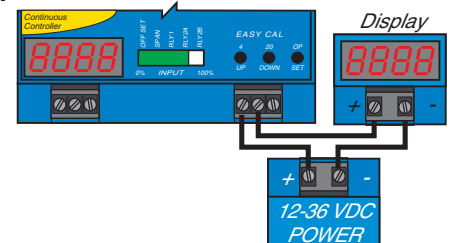

INSTALLATION

Step Six

VAC Power Input Wiring:

Observe the POWER SUPPLY label on the LC52. The label identifies the power requirement (120 or 240 VAC) and the terminal wiring. **Note:** Polarity does not matter with the AC input terminal.

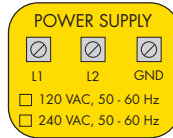
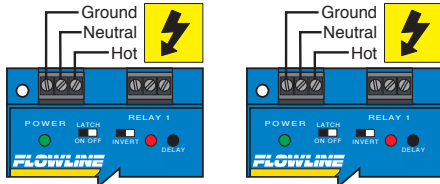

Relay Input Wiring:

The single pole, double throw isolated relay is rated 250 VAC, 10 A, 1/2 Hp. The two terminals marked Normally Open (NO) and Normally Closed (NC) will be used in different applications. **Note:** The "Normal" state is when the relay's coil is de-energized and the Red relay LED is Off.

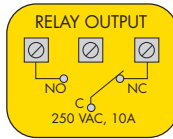

Low-Level Alarm:

The goal is to make sure that the liquid level does not fall below a certain point. If it does, an alarm is supposed to sound, alerting the operator of a low-level condition.

If power is accidentally cut to the controller, the sensor's ability to warn the operator of a low-level condition could be lost. The system must alert the operator not only to low fluid level, but to controller power loss.

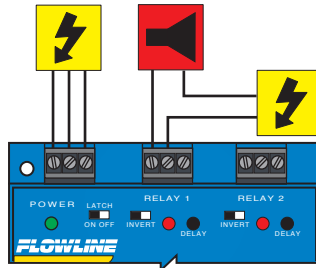

To do this, connect the hot lead of the alarm to the NC side of the relay terminal of the LC52. If

power is lost, the relay will be de-energized, and the alarm will sound (if there is still power to the alarm circuit itself). The alarm circuit should have a non-interruptible power supply or some other indicator or backup alarm to warn of a power failure in the alarm circuit.

In this application, the normal status of the sensor at the bottom of the tank will be wet, and the relay will be energized holding the alarm circuit open. Both the red relay LED and amber input LED will be on simultaneously, so for this application, INVERT should be set to the OFF position.

High Level Alarm:

In the same manner, the controller can be used to sound an alarm when fluid reaches a high level, with just a change in the location of the sensor and the setting of the INVERT switch.

- The alarm is still connected to the NC side of the relay to allow for a power failure alarm.
- The sensor is normally dry. In this dry condition, we want the relay to be energized so the alarm does not sound: i.e., the red relay LED should be on whenever the amber sensor LED is off. So we turn INVERT ON. If the fluid level rises to the high sensor point, the sensor goes on, the relay de-energizes, and the alarm sounds.

INSTALLATION

Step Seven

Automatic Fill:

This system consists of a tank with a valve controller by the LC52. At a low set point, the valve opens, filling the tank. At the high set point, the valve closes. Part of a proper fail-safe design for this particular system is that if power is lost to the controller for any reason, the valve filling the tank must close. Therefore, we connect the valve to the NO side of the relay. When the relay is energized, the valve will open and fill the tank. The relay indicator will correspond directly to the Open/Close status of the valve.

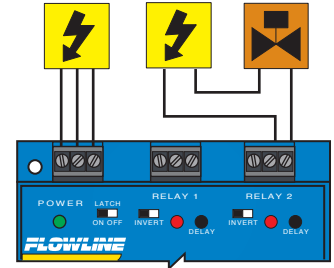

NOTE: If the device's load exceeds the rating of the controller's relay, a stepper relay of higher capacity must be used as part of the system design.

Determining the settings of LATCH and INVERT

This is the way the system must operate:

- When the liquid level is below the low set point, the valve should open, starting to fill the tank.
- When the liquid is above the low set point, the valve will remain open.
- When the liquid reaches the high set point, the valve should close.

Latch: In any two-sensor control system, LATCH must be ON.

Invert: Referring to the logic chart in Step One, we look for the setting that will de-energize the relay (valve close) when both inputs are ON (High level reached). In this system, Invert should be ON.

Automatic Empty:

In the same manner, the controller can be used to automatically empty a tank with just a change to the setting of the INVERT switch.

- The valve is still connected to the NO side of the relay to allow for a power failure fail-safe condition.
- The normal state of the valve is closed. In this state, we want the relay to be energized at the high set point (opening valve to drain tank). The relay will de-energize at the low set point (closing valve).

Note: A fail-safe design is important. If the tank is being passively filled, and a valve must be used to actively empty it, a power failure to either the controller or the pump circuits will cause overflow.

PROGRAMMING

Step Eight

OFFSET:

Equivalent to the 4 mA set point on the transmitter. Enter the value you would like to see when the LC52 receives 4 mA.

SPAN:







Equivalent to the 20 mA set point on the transmitter. Enter the value you would like to see when the LC52 receives 20 mA.

RLY1, RLY2A, RLY2B:

Set points for Relays. Values must be between OFFSET and SPAN.

Setting values:

With the Latch Off, ignore steps 9 and 10. RLY2B will not show during the programming section with Latch Off.

1. Press the SET button once. Immediately, the LED bar graph will begin to flash one Green bar next to OFFSET. 
2. Use UP / DWN buttons to change display to the desired OFFSET value.
3. Press the SET button again. Immediately, the LED bar graph will jump one Green bar to the right next to SPAN. 
4. Use UP / DWN buttons to change display to the desired SPAN value.
5. Press the SET button again. Immediately, the LED bar graph will jump one Green bar to the right next to RLY1. 
6. Use UP / DWN buttons to change display to the desired RLY1 value.
7. Press the SET button again. Immediately, the LED bar graph will jump one Green bar to the right next to RLY2A. 
8. Use UP / DWN buttons to change display to the desired RLY2A value.
9. Press the SET button again. Immediately, the LED bar graph will jump one Green bar to the right next to RLY2B. 
10. Use UP / DWN buttons to change display to the desired RLY2B value.
11. Press the SET button again. Immediately, the LED bar graph will return back to its normal operation of solid bars. 

EasyCal Calibration:

The Offset and Span points may be programmed directly to a specific level in the tank. These are the EasyCal 4 (EC4) and EasyCal 20 (EC20) values. **Note:** the level of the tank must physically be at its desired level when using EasyCal. If not, the EasyCal will accept the level and the values on the display will be incorrect. Use the factory reset to start over if this occurs.

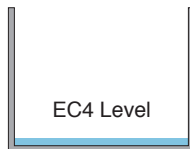

To calibrate EC4, set the tank to the new Offset level. Press [4] button once and [E] will appear in the display. Press [4] button again and [C] will appear in the display and EC4 is set.

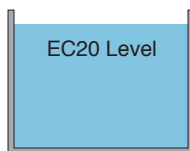

To calibrate EC20, set the tank to the new Span level. Press [20] button once and [E] will appear in the display. Press [20] button again and [C] will appear in the display and EC20 is set.

TROUBLESHOOTING

Step Nine

Factory Reset:

Returns the LC52 to its original factory set points, including setting the OFFSET to 4 mA and the SPAN to 20 mA. Hold both the 4/UP and 20/DWN buttons when adding power to the LC52.



Factory Settings for the LC52 Controller

OFFSET	SPAN	RLY 1	RLY 2A	RLY 2B
4.0	20.0	6.0	18.0	8.0

Lock Out Function:

Press both delay buttons and the DWN button to lock out all push button functions on the LC52. Press both delay buttons and the UP button to unlock all push button functions on the LC52.

Lock Out ON

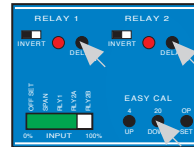

Lock Out OFF

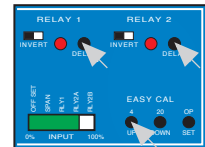

Re-Span the LC52:

Do a factory reset of the LC52 (holding the [4] and [20] buttons while adding power to the unit). Next set the level transmitter to send a 20 mA current. On the LU30-5003, set the EC20 to the level the LU30 is currently reading. While a 20 mA current is being sent to the LC52, adjust the R23 potentiometer until the display reads 20.0. Once completed, repackage and program the LC52 and return the EC20 value on the LU30 back to its correct setting. Note: the R23 Potentiometer can be reached by removing the front label of the LC52 and using a long jewelers screwdriver to reach it. R23 is located underneath the red LED on the LED bar graph approximately halfway down the PCB. Use extreme caution when adjusting R23.

EXERCISE

Step Ten

The following exercise demonstrates inventory control with automatic filling and a high level alarm. The usable range is 60 inches of liquid. The pump starts filling at 10 inches of liquid and stops filling at 50 inches of liquid. A high level alarm occurs at 55 inches of liquid.

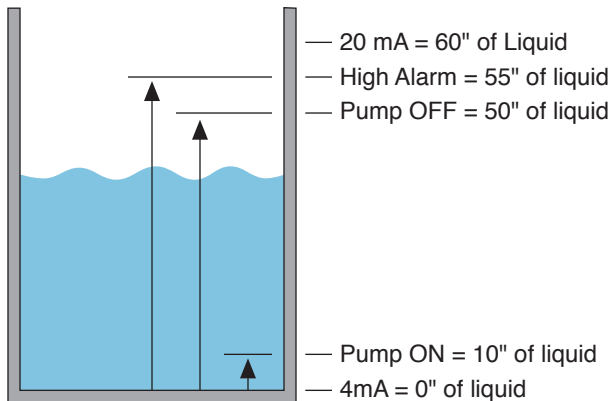

Enter all values into the LC52 in inches. The OFFSET is the corresponding 4 mA setting in inches. The SPAN is the corresponding 20 mA setting in inches. RLY2A and RLY2B is dedicated to the filling of the tank because RELAY2 is a latching relay. RLY1 is dedicated to the high level alarm because it is a single set point relay. Use the following values for programming the LC52-1001.

OFFSET	SPAN	RLY1	RLY2A	RLY2B
0.0	60.0	55.0	50.0	10.0

The next exercise demonstrates the same inventory control with automatic filling and a high level alarm. However, the units have been changes from inches to gallons. Within the tank, 1" = 50 gallons of liquid. The usable range is now 300 gallons of liquid. The pump starts filling at 50 gallons of liquid and stops filling at 250 gallons of liquid. A high level alarm occurs at 275 gallons of liquid.

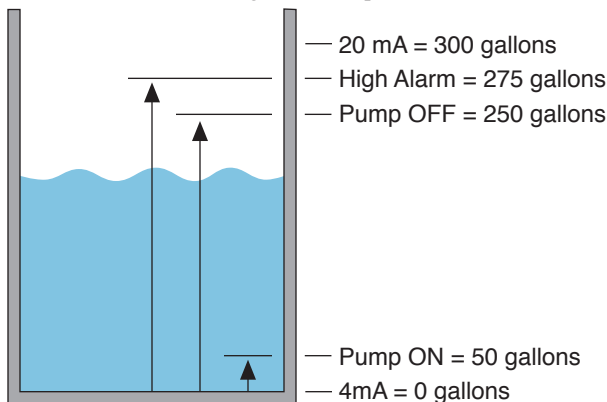

Enter all values into the LC52 in gallons. The OFFSET is the corresponding 4 mA setting in gallons. The SPAN is the corresponding 20 mA setting in gallons. RLY2A and RLY2B is dedicated to the filling of the tank because RELAY2 is a latching relay. RLY1 is dedicated to the high level alarm because it is a single set point relay. Use the following values for programming the LC52-1001.

OFFSET	SPAN	RLY1	RLY2A	RLY2B
0	300	275	250	50

EXERCISE

Step Eleven

The following exercise demonstrates inventory control with a high and low level alarm. The usable range is between 16 and 56 inches of liquid. The high level alarm occurs at 50 inches of liquid and the low level alarm occurs at 20" of liquid.

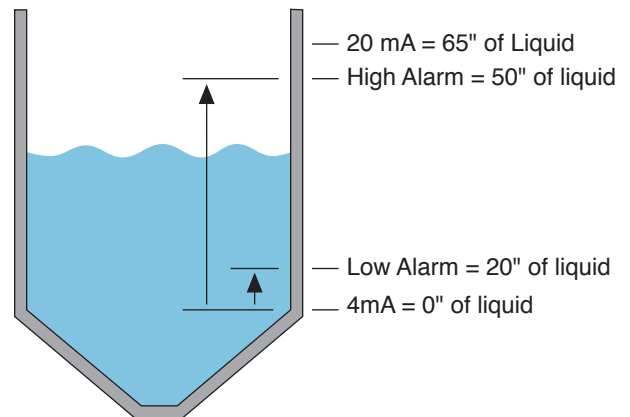

Enter all values into the LC52 in inches. The OFFSET is the corresponding 4 mA setting in inches. The SPAN is the corresponding 20 mA setting in inches. RLY1 is dedicated to the high level alarm because it is a single set point relay. RLY2A is dedicated to the low level alarm because the latch is turned off on Relay 2. Use the following values for programming the LC52-1001.

OFFSET	SPAN	RLY1	RLY2A
16.0	56.0	50.0	20.0

The next exercise demonstrates the same inventory control with a high and low level alarm. However, the units have been changes from inches to gallons. Along the straight side of the tank, 1" = 50 gallons of liquid. The usable range is now from 50 to 250 gallons of liquid. The high level alarm occurs at 220 gallons of liquid. The low level alarm occurs at 70 gallons of liquid.

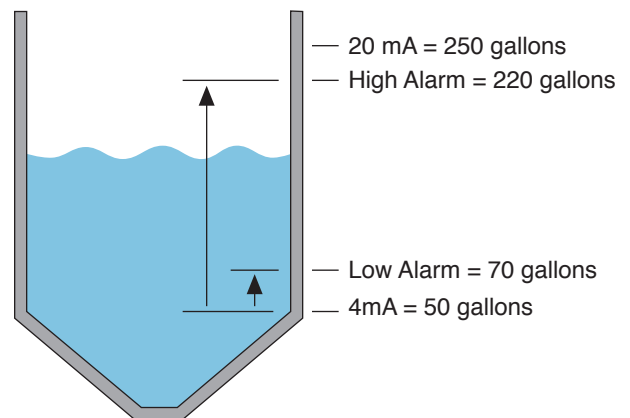

Enter all values into the LC52 in gallons. The OFFSET is the corresponding 4 mA setting in gallons. The SPAN is the corresponding 20 mA setting in gallons. RLY1 is dedicated to the high level alarm because it is a single set point relay. RLY2A is dedicated to the low level alarm because the latch is turned off on Relay 2. Use the following values for programming the LC52-1001.

OFFSET	SPAN	RLY1	RLY2A
50	250	220	70