



More Precision.

optoCONTROL CLS-K

Fibre optic sensors for gap, diameter, edge and presence



optoCONTROL CLS-K



In many automation and assembly technology applications, standard versions of optical sensors cannot be used, due to adverse ambient conditions such as high temperatures, small installation spaces or restricted access.

For these tasks, MICRO-EPSILON Eltrotec has developed fibre optic sensors as a specific solution for these applications, for which the evaluation electronics (amplifier) and the opto-electronic components (fibre optic) are arranged separately. The fibre optic sensors consist of a transmitter and receiver for infrared or ultraviolet light, with subsequent signal processing. A high-quality glass fibre optic provides precision light transmission according to the principle of total reflection.

The measuring and test amplifiers optoCONTROL CLS-K are offered as infrared or ultraviolet-light types, starting at a wavelength of 280 nanometres, and they enable measuring frequencies of 4 to 8 kHz at resolutions starting from 0.1mm.

The electronics on the optoCONTROL CLS-K offer variable amplification; the output signal is available for downstream systems as a voltage or current signal. In addition to these, there are versions with electrically isolated optocoupler or relay outputs, displays, as well as a special version that provides temperature compensation and is protected to IP65.

These fibre optic sensors enable a wide variety of applications, from monitoring the presence of and recognising the position of components in automatic assembly machines, feeding systems, test and inspection applications, through to gap and web-edge detection.



Table of contents

Fibre optic sensors

optoCONTROL CLS-K Fibre optic sensor for automation	4 - 5
optoCONTROL CLS-K-6 Measuring fibre optic sensor	6 - 7
optoCONTROL CLS-K-UV Fibre optic sensor for glass detection	8 - 9





Fibre optics

Order code.....	10 - 14
Mountable lenses for fibre optics	16 - 17

optoCONTROL CLS-K

Fibre optic sensor for automation



-  **Response time $\leq 120\mu\text{s}$**
-  **Switching frequency $\leq 4\text{kHz}$**
-  **Fibre optic adaption**
-  **Analogue output 0.1 - 5VDC**

The basic sensor for automation tasks

Features:

- Scanning distance up to 200mm*
- Range of up to 2m*
- * Depending on the Fibre bundle diameter
- Switching output: NPN, PNP, optocoupler, relay (depending on the version)
- Drop-out delay 5-100ms adjustable (optional)
- Stable long-term behaviour by monitoring and regulating the emission of the transmitter diode

Applications:

- Test & measurement tasks
- Position recognition of small parts
- Position and assembly monitoring on automatic assembly machines and conveyor systems
- Detecting presence of parts
- Checking of length and diameter
- Option: UV version for glass recognition

Benefits:

- Precise and reliable object detection
- Low drift via transmission monitoring, making it particularly suitable for measuring tasks
- High switching frequency and short response time
- Sensor monitoring via analogue signal

Range / sensor:

one way ^{*3}			sensor	
Fibre bundle \varnothing mm	range mm (typ.) ^{*1}	min. object size typ.	Fibre bundle \varnothing mm	range mm (typ.) ^{*1 *2}
0.6	90	≤ 0.05	0.6	≤ 10
1.0	200	≤ 0.1	1.0	≤ 30
1.5	500	≤ 0.1	1.5	≤ 80
2.5	1,700	≤ 0.2	2.5	≤ 165
3.0	2,000	≤ 0.3	3.0	≤ 180

*1: with 90° angular sensor mechanisms reduced range

*2: related to Kodak white 90%

*3: See page 10 ff.

Resolution (Example):

Cross-section converter Typ Q2 (10 mm Fibre gap) with Fibre optic type FAD; 80% can be used with CLS-K achieving a resolution of 50 - 80 points

For edge or gap detection a resolution of 0.1mm can be achieved (related to 8mm).

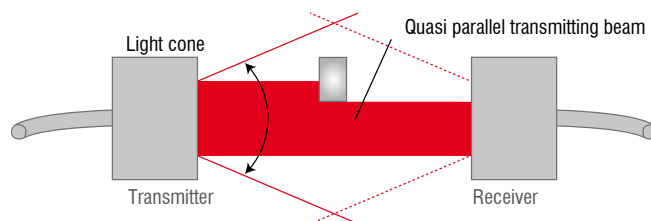

opto CONTROL CLS-K:

Measuring and test amplifiers with fibre optics as recording component for intensity measurement between two fibre optic cross-section converters - the advantageous kind of edge measurement on tracks from $>0.1\text{mm}$ resolution with up to 8kHz.

Type CLS-K	10	11	20	30	31	40	50	51
Order No.	10010023	10010024	10040025	10040027	10020028	10040029	10040030	10040031
Operating voltage VDC	10-30	10-30	24	10-30	10-30	24	10-30	10-30
Residual ripple	≤ 10%							
Current consumption	~ 50mA							
Switching delay	≤ 500ms							
Response time	≤ 120μs							
Temperature drift	≤ 0.5% /K							
Reproducibility	≤ 1% bei Δδ = 2K							
Switching state	LED display red and green							
Operating mode	Light and dark switch output				Light/dark switching switchable			
Sensitivity	Adjustable with 10-turn potentiometer P1							
Range switching	1:100 (Short range : Long range)							
Hysteresis	≤ 10%							
Protection class	With mounted fibre optic							
Ambient temperature range	0 to +50°C							
Storage temperature range	-25°C to +70°C							
Housing material	Macrolon 8030/UL94V1, transparent cover, blue lower part							
Weight, Dimensions	approx. 215g/135g, 125x42x45mm							
Switching output (*short-circuit protected)	Transistor* 2x NPN O.C.		Relays 1x changeover contact	Optocoupler	PNP*	Relays 1x changeover contact	Optocoupler*	PNP*
Switching voltage	30VDC		0.01-250VAC 0.01-220VDC	30VDC	30VDC	0.01-250VAC 0.01-220VDC	30VDC	30VDC
Switching current	5-100mA		50μA-2A	5-100mA	5-100mA	50μA-2 A	5-100mA	5-100mA
Switching power			5 μW-60W 125VA			5 μW-60W 125VA		
Switching frequency max.	4kHz		60Hz	4kHz	4kHz	60Hz	4kHz	4kHz
Saturation voltage	≤ 2.0V			≤ 2.0V	≤ 2.0V		≤ 2.0V	≤ 2.0V
Pulse stretching 5-100ms	Adjustable with potentiometer P2							
Analogue output	0.1-5 VDC, Output resistance 1kOhm							
Type of connection	Line 2m		Screw connectors 1.5mm ² ((plug-in version upon request))					

Dimensions:

Dimensions in mm, not to scale

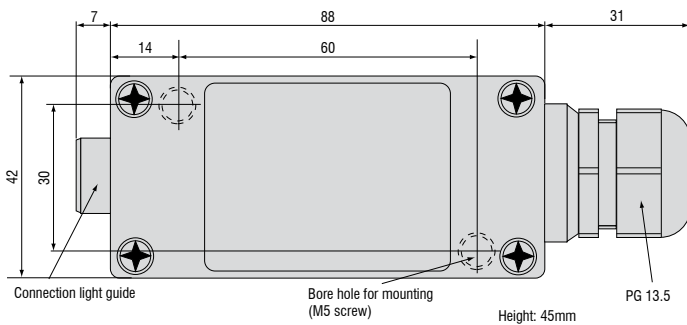

Connections:

Terminal block

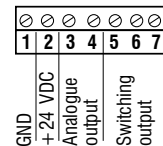

Output:

CLS-K-11: NPN O.C.
 CLS-K-20/40: Relay
 CLS-K-30/50: Optocoupler o.c. / o.E
 CLS-K-31/51: PNP
 All light/dark switches versions

Control and display interface

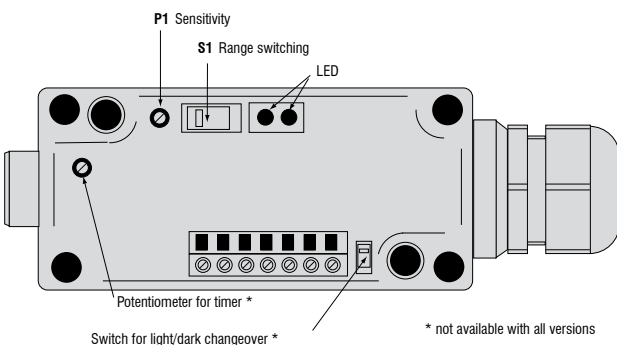

Connection cable

brown — GND
 pink — +24 VDC
 green — Analogue output +
 yellow — Analogue GND output
 grey — NPN-Switching output *1
 white — NPN-Switching output *2

Output:





CLS-K-10: NPN O.C.

*1 dark switching
 *2 light switching

optoCONTROL CLS-K-6

Measuring fibre optic sensor



-  **Response time $\leq 120\mu\text{s}$**
-  **Switching frequency $\leq 4\text{kHz}$**
-  **Analogue display**
-  **Analogue output 0 - 10VDC;
0 - 20mA; 4 - 20mA**

With measuring function
The basic sensor for automation tasks

Features:

- Scanning distance up to 200mm*
- Range of up to 2m*
- * Depending on the Fibre bundle diameter
- Supply 12-30VDC
- NPN switching output
- Stable long-term behaviour by monitoring and regulating the emission of the transmitter diode

Applications:

- Test & measurement tasks
- Checking of length and diameter
- Produktion monitoring via analogue output and display
- Assembly monitoring
- Option: UV version for glass detection
- Indirect displacement via cross-section converter fibre optic

Benefits:

- Low drift by transmission monitoring
- Short response time
- Sensor monitoring via analogue signal
- Each fibre optic of the FASOP program is usable
- Each special fibre optic can be implemented starting at 1 piece

Application examples:

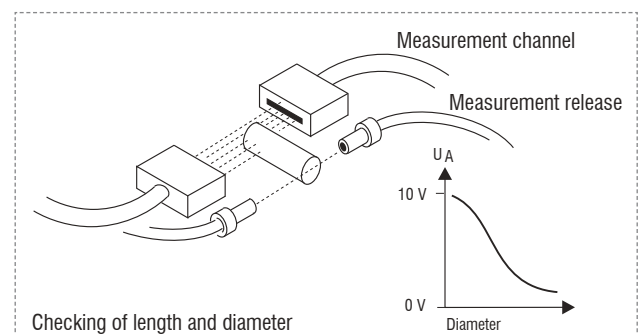
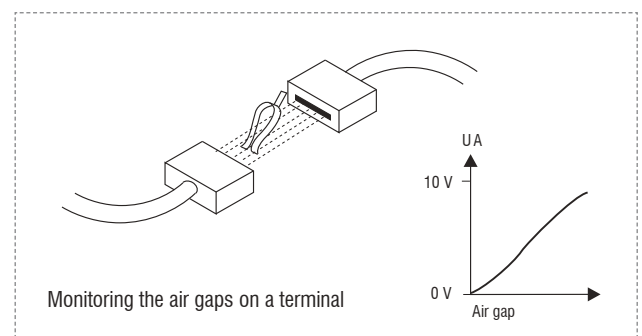
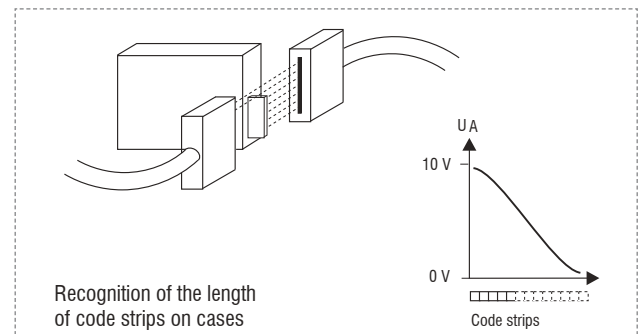

Type CLS-K	60	61	63	65
Order No.	10030032	10030033	10030035	10030036
Current consumption	12-30VDC			
Residual ripple	≤ 10%			
Current consumption	~ 70mA			
Switching delay	≤ 500ms			
Switching frequency	≤ 4kHz			
Response time	≤ 120μs			
Temperature drift	≤ 0.5% /K			
Reproducibility	≤ 1% bei Δθ = 2K			
Hysteresis	≤ 10%			
Analogue output	0-20mA	0-10VDC	0-20mA	4-20mA
Voltage output	Load ≤ 600Ω			
Switching output	Transistor 2x NPN O.C.			
Switching voltage	30VDC			
Switching current	5-100mA			

Type CLS-K	60/ 63/ 65	61
Sensitivity	Adjustable via 10-level potentiometer P1	
Range switching	1:100 (Short range : Long range)	
Switching state	LED-display red/green	
Operating mode	Light/dark switching output	
Protection class	IP 65 (with fibre optic)	
Current consumption and output	Transient-protection polarity and short-circuit protection	
Ambient temperature range	0 to 50°C	
Lagertemperatur	-25°C to 70°C	
Type of connection	Screw connectors	Line 2m
Housing material	Macrolon 8030 / UL94V1	
Weight	approx. 215g/135g	

Dimensions:

Dimensions in mm, not to scale

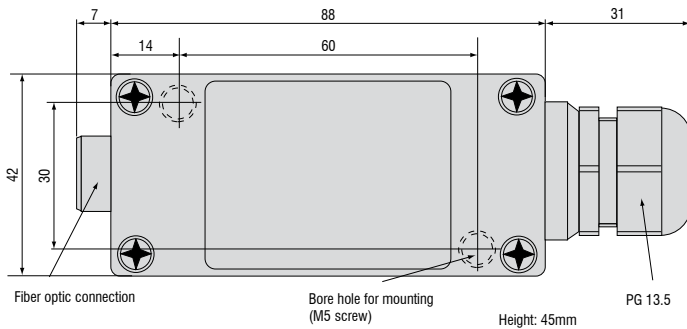

Connections:

CLS-K-60/63/65

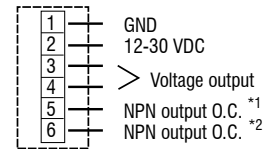

CLS-K-61

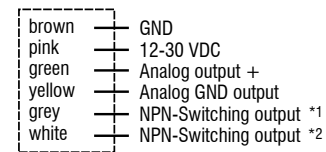

*1 dark switching
*2 light switching

Control and display interface:

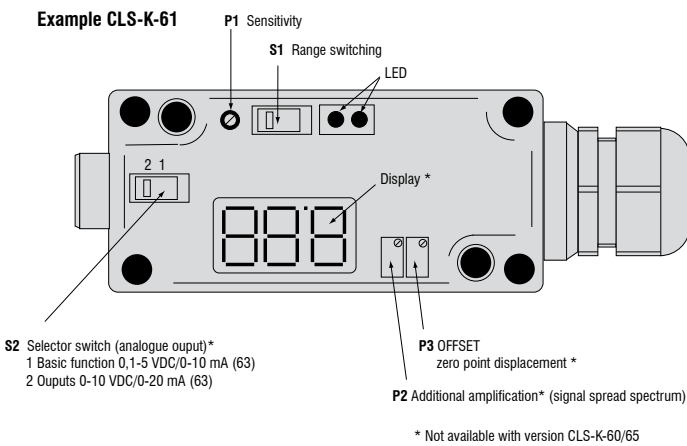

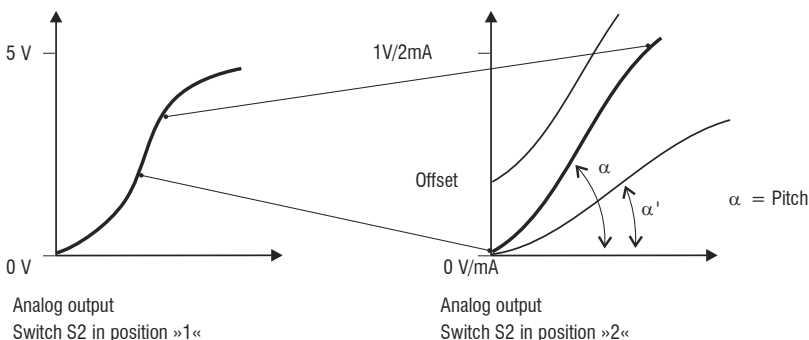

Functions:



The amplifier CLS-K-61/63 offers the possibility of a solution of an application, to spread the important signal range over the entire analogue range.

optoCONTROL CLS-K-UV

Fibre optic sensor for glass detection

-  **Response time $\leq 10\text{ms}$**
-  **Cut-off frequency $\leq 100\text{Hz}$**
-  **Analogue output 0.5 - 5VDC**



For glass/plexiglass detection

Features:

- Scanning distance 1-20mm
- In transmitted light* 1-100mm
- Supply 12-30VDC
Pole protected, short-circuit protected
- Switching output: NPN, PNP
(depending on the version/optocoupler)
- Hysteresis adjustable
- Drop-out delay adjustable 2-200ms
- Sensitivity adjustable
- Light and dark switching
- Wavelength typically 290nm

* Depending on the fibre optic and the surface

Applications:

- Glass-plate detection passing through, starting at 0.1mm thickness
- Glass-plate positioning, starting at precisely 0.1mm
- Stop position recognition for glass plates during production
- For glass, plexiglass and CDs (not for films)
- Inspection of coatings

Benefits:

- Modular via fibre optic connection
- Compact design
- Analogue output
- Reproducibility starting from 0.1mm
- Use in tight spaces
- Customer-specific fibre optics permeable for UV light

Application example

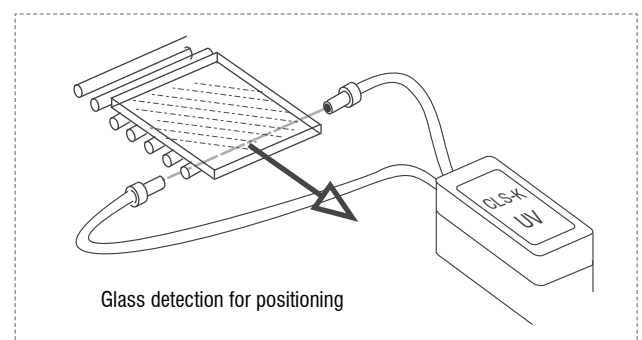

Type CLS-K-UV

Electrical data	Operating voltage UB	12-30VDC
	Residual ripple	≤ 10%
	Current consumption	~ 70mA typ.
Output	Switching output	PNP NPN (depending on the variant)
	Switching processes	light and dark switching
	Outputsstrom	≤ 200mA
	Switching voltage	≤ 30V (max. 36V)
	Cut-off frequency	≤ 100Hz (-3dB)
	Response time	≥ 10ms
	Drop-out delay	2-200ms (adjustable)
	Switching delay	≤ 200ms
Analogue output	Hysterese	5-50% (adjustable)
	Protection	Pole protected, short-circuit protected
Light source	Voltage	0.5 - 5VDC (Load resistance $R_L \geq 2k\Omega$)
	LED	UV, wavelength typ. 290nm
Environmental influences	Modulation frequency	typ. 2.8kHz
	Permissible operating temperature	0 to +50°C
	Permissible storage temperature	-25 to +70°C
	Permissible rel. humidity	90% (non-condensing)
Mechanical tasks	Life expectancy	typ ≥ 5000 hours
	Protection class	IP 65 (with mounted fibre optic)
	Weight	approx. 215g/ 135g
	Material	Macrolon 8030/UL54V1, cover transparent
	Connection (depending on the variant)	M12 connector, 5 pin or connection 2m

Order code

Typ	Type of connection	PNP	NPN	Analogue	Art. No.
CLS-K-121/UV PNP	Cable*	x		x	10064149
CLS-K-122/UV PNP	Connector	x		x	10064153
CLS-K-141/UV NPN	Cable*		x	x	10064156
CLS-K-142/UV NPN	Connector		x	x	10064158

Accessories	Description	Art. No.
Article		
Connection for connector version	5 pin with connector (cable box) PUR, 2m	11231168
Fibre optic (FASOP)	See page 10 ff. (e.g. FAD-M-A2.0-2.0-1200-UV)	

*Cable design: 6 wired, 2m, PVC

Dimensions:

Dimensions in mm, not to scale

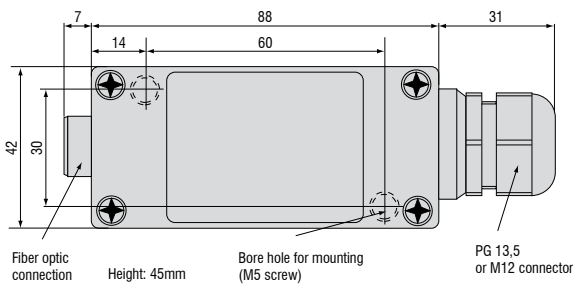

Connections:

Connector version

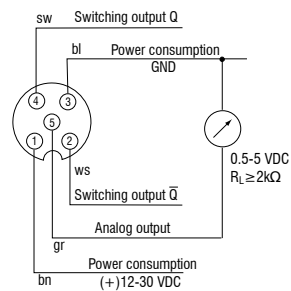

Control and display interface:

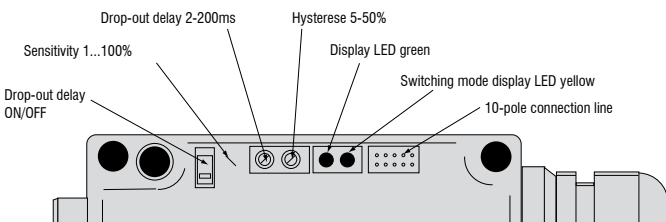

Cable version

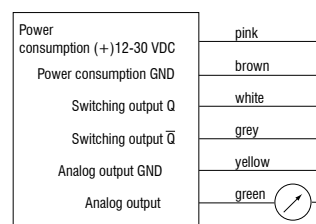

Fibre optics



- ▶ High-quality fibre optics with polished and ground end-faces
- ▶ Fibres for visible, ultraviolet and infrared light
- ▶ For wavelengths from 190 – 2500nm

Features:

- Temperature stability from -40°C to $+400^{\circ}\text{C}$ (special bonding)
- Various aperture angles available 68° (NA0.86), 22° (NA0.21), 121° (NA0.87)
- Maximum cable lengths of 30m available; default lengths: 600, 1200, 1800 or 2400mm
- Large selection of sensor mechanisms for different tasks

Standard versions

Micro-Epsilon fibre optics for colour sensors and fibre optic sensors for measurements and testing feature a high build and transmission quality.

Ground and polished end-faces ensure excellent optical integration with adapted sensors. A large selection of sensor mechanisms provides optimum flexibility for a great variety of tasks.

Special versions

Fibre optics with increased vibration protection

Fibre optics can be manufactured to include increased vibration protection for use with high mechanical loads, such as shock, acceleration, and movement. This special treatment minimises friction between fibres and reduces shocks

Fibre optics with special bonding for high temperatures

Standard bonding is suitable for maximum temperatures of 80°C . Special adhesives allow for temperatures of up to 250°C , even 400°C . These higher temperature ranges require the use of Type E stainless steel sheathing. Temperatures of up to 600°C can be reached with metallized fibres and with sapphire optics installed.

Customer-specific designs

One of the advantages of Micro-Epsilon fibre optic manufacturing is the production of customer-specific designs for various complex sensor mechanisms.

Technical data for FASOP fibre optics

Single fibre diameter	20, 30, 50, 70 μ m standard fibre (depending on structure)		
Aperture angle	standard fibres	67° (NA 0,56)	
	special fibres	22° (NA 0.21) 121° (NA 0.87 / wide angle) 22° UV (80/100 μ m) 22° IR (80/100/150 μ m)	
Material	optical glass (e.g. for UV / IR / in quartz glass)		
Dielectric strength	50kV/m with PVC protective sheath		
Sensor mechanism – temperature range, fibre bonding	standard	-20°C to + 80°C	
	T250	0°C to + 250°C	
	T400	0°C to + 400°C	
	T600	0°C to + 600°C	
Permissible temperature range with sheathing that has appropriate fibre bonding	PVC	-20°C to +80°C	(P) (Z)
	metal	+40°C to +180°C	(M)
	metal with special bonding	-40°C to +400°C	(E)
	metal/silicone	-40°C to +180°C	(T)
Fibre transmission	usable for wavelengths from 190-2500nm of different types (we can provide the most suitable solution depending on the requirements) Transmission curves on request!		

Order code for fibre optics

You can see an overview of the Fasop fibre optic range on the following pages.

You can define your own individual fibre optic from the various components using the order key.

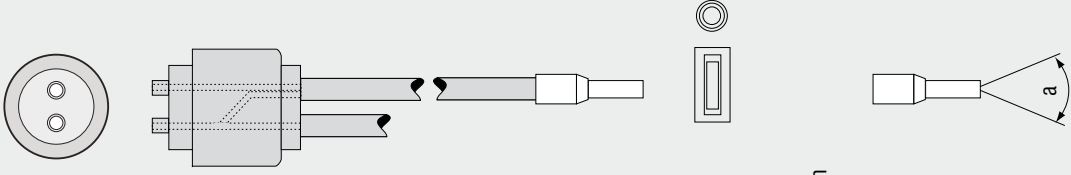

The diagram illustrates the components of a fibre optic system, each corresponding to a part of the ordering code. From left to right, the components are: Adapter, Function, Sheathing, Sensor mechanism versions, Fiber gap/fibre bundle, Overall length, and Aperture angle a .

Ordering code

FA	D	T	A 2.0	2.5	1200	67°
1	2	3	4	5	6	

- 1** Adaption to FA-Adapter
- 2** Function of the fibre optic (D = transmitted light mode, R = reflex mode)
- 3** Sheathing e.g. silicone-metal sheath (T)
- 4** Sensor mechanism type, e.g. A2.0
Fibre bundle e.g. 2.5mm dia.
- 5** Overall length of e.g. 1200mm (standard length / bearing types)
- 6** Aperture angle of the fibre, e.g. 67 °

1 Adapter version

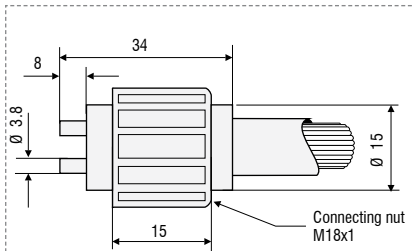

Adapter, FA System FASOP

2 Functions

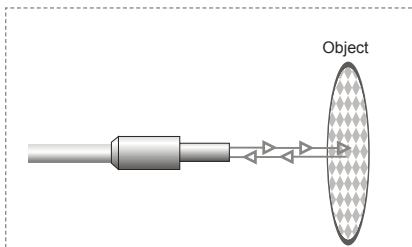

R Reflected light operation (button)*

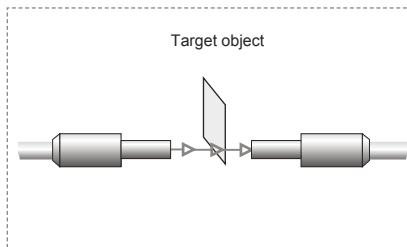

D Transmitted light operation (barrier)*

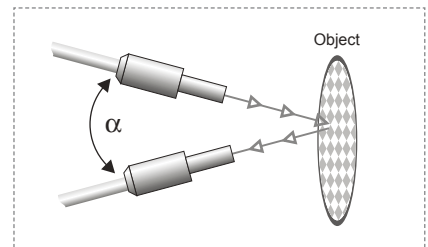

D Transmitted light operation (V arrangement) for reflective and shiny surfaces

* All functions can also be performed as multiple reflex and transmitted light functions

3 Sheathing

Silicone metal sheath

Metal wire-spiral-reinforced hose with glass fibre braiding and silicone rubber sheathing

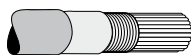

Characteristics

Very flexible, highly resistant to bending, tension and torsion; temperature-stable to 180°C, liquid-tight

T

Stainless-steel sheath

Flexible stainless steel wire-spiral-reinforced hose ¹⁾



Characteristics

Flexible, protection against mechanical stress, temperature-stable to 400°C

E

Metal sheath

Flexible brass wire-spiral-reinforced hose ¹⁾



Characteristics

Flexible, protection against mechanical stress, temperature-stable to 180°C

M

¹⁾ Bending radius corresponds to three times the external diameter of the sheath.

²⁾ Bending radius corresponds to twice the external diameter of the sheath.

Details of sheath diameters can be found in Section 4:

Please note: Every version can be supplied with increased vibration protection (VS). See the „Special versions“ section for more information

PVC-metal sheath

Flexible brass spiral-reinforced hose coated with PVC sheathing ¹⁾

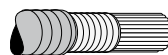

Characteristics

Flexible, protection against mechanical stress, temperature-stable to 80°C

Z

PVC special sheath

Highly flexible plastic hose ²⁾



Characteristics

Highly flexible, small sheath diameter, temperature-stable to 80°C

P

4 Sensor mechanism variants and fibre bundles

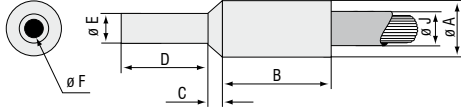

Type	A Ø	B	C	D	E Ø	F Ø	P	Ø J M	T
A 1.0	4.6	8	2	11	2.5	1.5	4	4	-
A 1.1	6.6	8	2	11	2.5	1.5	-	5	4.4
A 2.0	6.6	10	2	12	4.5	2.5	6	6	5.8
A 3.0	8.5	11	2	15	6	3	7	7	7.5

A Type A ferrule, stainless steel

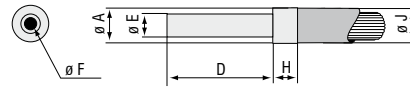

Type	A Ø	D	E Ø	F Ø	H	Ø J P	Ferrule
B 1.1	2	30	1	0.6	2	2	stainless steel
B 1.2	2	10	1	0.6	2	2	stainless steel
B 2.0	3	10	2	1	2	3	alu
B 3.0	5	12	4	2.5	2	5	alu
B 4.0	8	12	6	3	2	8	alu

B Type B ferrule
(only suitable for PVC sheathing)

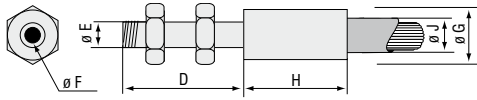

Type	D	E	F Ø	G Ø	H	P	Ø J M	T
C 1.0	30	M4	1.0	6	13	5	5	4.4
C 2.0	30	M6	2.5	8	15	6	6	5.8
C 3.0	30	M10	3	11	12	7	7	7.5

C Type C ferrule, stainless steel

**Standard sensor mechanism, bonding
for -20°C to +80°C
Special designs available (T250, T400, T600)**

All details in mm
Tolerances: typ. +/- 0.1mm
Al ferrule, black anodised

**Different sizes are possible by arrangement,
please ask our product specialists.**
(see also the „Special versions“ section)

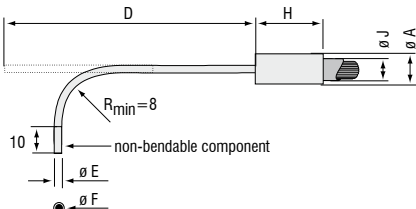

Type	A Ø	D	E Ø	F Ø	H	P	Ø J M	T
O 1.0	2	100	1	0.6	10	2	-	-
O 1.1	7	100	1	0.6	20	-	5	4.4
O 2.0	3	100	1.3	1	10	3	-	-
O 2.1	7	100	1.3	1	20	-	5	4.4

O Type O ferrule
Bendable, to an extent

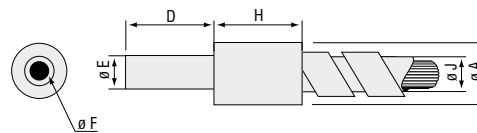

Type	A Ø	D	E Ø	F Ø	H	Ø J M	T	Ferrule
M 1.1	6	30	1	0.6	10	5	4.4	stainless steel
M 1.2	6	10	1	0.6	10	5	4.4	stainless steel
M 2.0	6	10	2	1	10	5	4.4	alu
M 3.0	7	12	4	2.5	12	6	5.8	alu
M 4.0	9	12	6	3.5	12	7	7.5	alu
M 5.0	12	16	7	5	16	9	9	alu
M 6.0	13	16	8	6	18	10	11.5	alu
M 8.0	16	20	10	8	20	13	13.5	alu
M 10.0	18	20	12	10	20	15	-	alu

M Type M ferrule

4 Sensor mechanism variants and fibre bundles

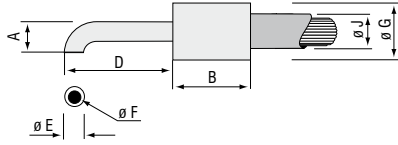

Type	A Ø	B	D	E Ø	F Ø	G Ø	r	P	ØJ M	T
D 1.0	2.5	10	20	1	0.6	3	1.5	2	-	-
D 1.1	2.5	13	20	1	0.6	6	1.5	-	-	4.4
D 2.0	6	13	20	2	1.5	6	4	5	5	4.4
D 3.0	15	17	20	5	2.5	9	10	7	7	6.5

D Type D ferrule, stainless steel
(* D1.0 only suitable for PVC sheathing)

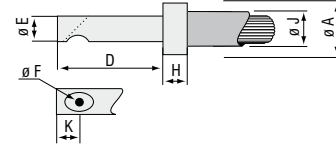

Type	A Ø	D	E Ø	F Ø	H	K	P	ØJ M	T
E 1.0	4	20	3	1.5	1.5	4	4	-	-
E 2.0	5	20	4	2.5	1.5	4	5	5	-
E 2.1	7	20	4	2.5	10	4	-	-	5.8
E 3.0	8	20	6	3	1.5	5	7	7	-

E Type E ferrule, stainless steel
(* E1.0 only suitable for PVC sheathing)

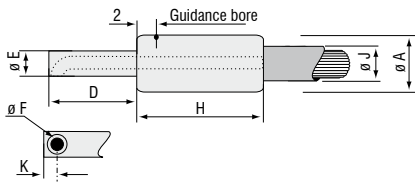

Type	A Ø	D	E Ø	F Ø	H	K	P	ØJ M	T
F 1.0	8	20	6	1.5	9	3	5	5	5.8
F 2.0	10	20	8	2.5	10	4	6	6	6.5
F 3.0	12	20	10	3	10	5	7	7	7.5

F Type F ferrule, stainless steel

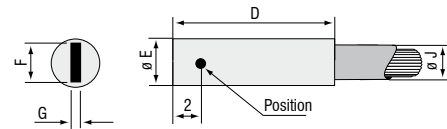

Type	D	E Ø	F	G max.	P	ØJ M	T
R 1.0	25	4	3	0.5	3	-	-
R 1.1	30	7	3	0.5	6	6	5.8
R 2.0	25	7	6	1	6	6	5.8**
R 2.1	30	10	6	1	-	7	7.5

R Type R ferrule, aluminium
* R1.0 only suitable for PVC sheathing
** at 6x1 mm², can be made to a length of 1200

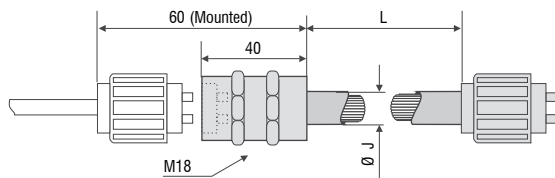

Fibre bundle Ø	P	ØJ M	T	L
(3mm)/ channel	12	13	13.5	

LV Type LV ferrule
Fibre optic extension / feed-through

All details in mm
Attention: With angular sensor mechanism versions, a reduction in range can be expected compared to axially emerging versions.

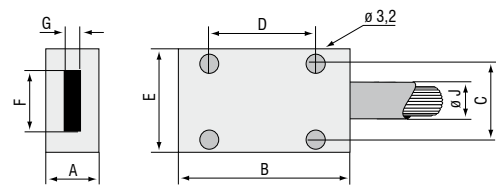

Typ	A	B	C	D	E	F	G	ØJ
Q1	12	25	9	15	15	5	0.5	dependent on fibre cross-section
Q2	12	30	14	20	20	10	0.3	
Q3	12	35	24	25	30	18	0.3	
Q4	12	55	34	40	40	28	0.2	
Q5	12	55	44	40	50	38	0.15	
Q6	12	55	54	40	60	48	0.15	
Q7	16	75	64	60	70	58	*	
Q8	16	75	74	60	80	68	*	
Q9	20	90	84	75	90	78	*	
Q10	20	90	94	75	100	88	*	

(F x G 3.5 mm² for CLS and IFA applications with FA adapter)

Q Type Q, aluminium
Also available in stainless steel

5 + 6 Length and aperture angle



Standard lengths are: 600*, 1200*, 1800 and 2400mm.

* Bearing types

Length tolerance type: +/- 4%

Cable lengths of up to 30m can be supplied on request!

5

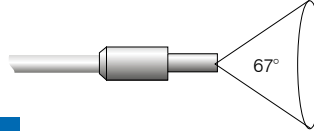
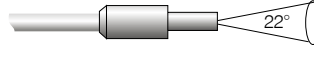

Dependent on the glass fibre material used the following aperture angles are included in the standard range: 22°, 67°, 121°

6

Detection areas, various sensor mechanisms

Fibre bundle ØF mm	Working distance mm	Light spot for 67° fibre approx. Ø mm	Light spot for 22° fibre approx. Ø mm
0,6	5	3	3
	10	5	4
	15	8 ¹⁾	6
	20	12 ¹⁾	8
1	5	3	3
	10	7	5
	15	11	8 ¹⁾
	20	15 ¹⁾	11 ¹⁾
1,5	5	4	3
	10	7	5
	15	11	8
	20	19 ¹⁾	11
2,5	5	5	4
	10	10	8
	15	13	10
	20	19 ¹⁾	13
3	5	8	5
	10	12	7
	15	15	10
	20	18 ¹⁾	13

Typical values were determined using colorSENSOR LF2-ST

1) Can be realised only in certain conditions

Series KL-xx/xx



- ▶ Focussing of colour and fibre optic sensors
- ▶ Improving the efficiency of the application
- ▶ Many possible applications

Features:

- Working distances from 8mm to 200mm
- Scratch-resistant glass lens
- Robust aluminium housing (black anodised)
- Bundling to a small light spot
- Increasing the range
- Minimum colour change when the distance is altered
- High luminous efficiency
- Special designs possible, according to customer requirements
- Colour measurement on small objects at a relatively large distance (KI-3, KL-4)
- Recognising highly absorbent objects (KL-5, KL-14, KL-17)

	Type	Article number	Object distance (typ.)	Detection range (typ.)*	Dimensions	LWL FASOP
	KL-3	10823012	8mm - 20mm	1mm - 5mm	L x Ø ap. 60mm x 15mm	A 2.0 ³⁾
	KL-M18-A2.0	10823020	15mm - 50mm	2mm - 10mm	L x Ø ap. 51mm x M18 x 1	A 2.0 ¹⁾
	KL-M34	10823278	80mm - 150 mm	10mm - 20mm	L x Ø ap. 85mm x M34 x 1.5	A 2.0 ¹⁾
	KL-M34/62	10824196	80mm - 150 mm	2mm - 5mm	L x Ø ap. 170mm x 62mm	A 2.0 ¹⁾
	KL-4	10823262	8mm - 20mm	0.6mm - 3mm	L x Ø ap. 60mm x 15mm	A 1.1 ¹⁾
	KL-M18-A1.1	10824140	10mm - 50mm	2mm - 7mm	L x Ø ap. 51mm x M18 x 1	A 1.1 ¹⁾
	KL-D-40	10824143	15mm - 25mm	3mm - 5mm	L x W x H ap. 43.4 x 49.5 x 12mm	A 2.0 ²⁾
	KL-D-28	10824197	20mm - 30mm	5mm - 8mm	L x W x H ap. 31.7 x 40.5 x 15mm	A 2.0 ²⁾
	KL-D-20	10823021	20mm - 40mm	4mm - 10mm	L x W x H ap. 21.4 x 33 x 12mm	A 2.0 ²⁾
	KI-D-17	10823220	30mm - 80mm	8mm - 25mm	L x W x H ap. 36.5 x 25.5 x 15mm	A 2.0 ²⁾
	KL-D-14	10823022	60mm - 120mm	10mm - 20mm	L x W x H ap. 37 x 50 x 20mm	A 2.0 ²⁾
	KL-D-6	10823409	100mm - 200mm	15mm - 30mm	L x W x H ap. 31.1 x 45.1 x 20mm	A 2.0 ²⁾
	KL-5	10824198	8mm - 20mm	2mm x 0.3mm to 15mm x 3mm	L x Ø ap. 60mm x 15mm	R 1.1 ¹⁾
	KL-8	10823920	8mm - 20mm	4mm x 0.7mm to 30mm x 5mm	L x Ø ap. 60mm x 15mm	R 2.1 ¹⁾

*The smallest figure in the table relates to the smallest typical optical diameter that is generated. This corresponds to roughly the smallest detection area for colour or fibre optic sensors.

¹⁾ Reflex fibre optic (FAR)

²⁾ Transmitted light mode fibre optic cables (FAD)

³⁾ Can be realised in conjunction with FAR-X-A2.0-0.6-XXXX-67° reflex mode fibre optical cable (FAR) measurement spot of approx. 0.2mm

High performance sensors made by Micro-Epsilon



Sensors and systems for displacement and position



Sensors and measurement devices for non-contact temperature measurement



2D/3D profile sensors (laser scanner)

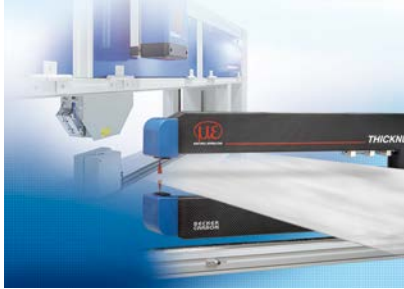

Measurement and inspection systems for quality assurance



Optical micrometers, fibre optic sensors and fibre optics



Colour recognition sensors, LED analyzers and colour online spectrometer

Modifications reserved / Y9761378-B011056GKE



SCIGATE AUTOMATION (S) PTE LTD

No. 1 Bukit Batok Street 22 #01-01 Singapore 659592

Tel: (65) 6561 0488

Fax: (65) 6562 0588

Email: sales@scigate.com.sg

Web: www.scigate.com.sg

Business Hours: Monday - Friday 8.30am - 6.15pm



MICRO-EPSILON Eltrotec GmbH

Heinkelstraße 2 · 73066 Uhingen / Germany

Tel. +49 (0)7161 98872-300 · Fax+49 (0)7161 98872-303

eltrotec@micro-epsilon.de · www.micro-epsilon.com