



SCIGATE AUTOMATION (S) PTE LTD

No.1 Bukit Batok Street 22 #01-01 Singapore 659592

Tel: (65) 6561 0488

Fax: (65) 6562 0588

Email: sales@scigate.com.sg

Web: www.scigate.com.sg

Business Hours: Monday - Friday 8.30am - 6.15pm

More Precision

optoCONTROL CLS1000 // Fiber optic sensor for industrial applications



Fiber optic sensor for industrial applications

optoCONTROL CLS1000

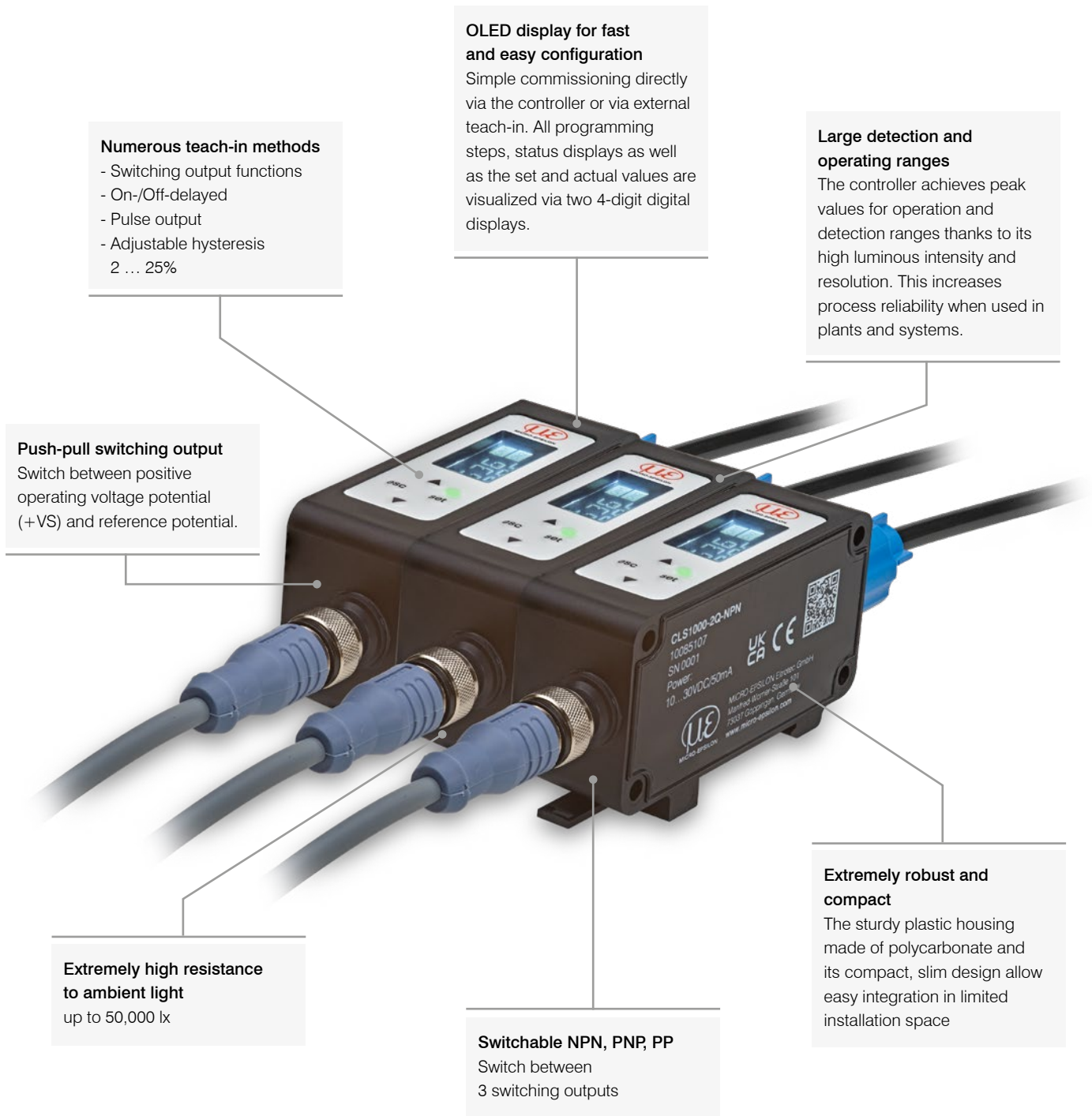

Numerous teach-in methods

- Switching output functions
- On-/Off-delayed
- Pulse output
- Adjustable hysteresis 2 ... 25%

OLED display for fast and easy configuration

Simple commissioning directly via the controller or via external teach-in. All programming steps, status displays as well as the set and actual values are visualized via two 4-digit digital displays.

Large detection and operating ranges

The controller achieves peak values for operation and detection ranges thanks to its high luminous intensity and resolution. This increases process reliability when used in plants and systems.

Push-pull switching output

Switch between positive operating voltage potential (+VS) and reference potential.

Extremely high resistance to ambient light
up to 50,000 lx

Switchable NPN, PNP, PP
Switch between
3 switching outputs

Extremely robust and compact

The sturdy plastic housing made of polycarbonate and its compact, slim design allow easy integration in limited installation space

High-performance fiber optic sensors for numerous monitoring tasks



Fiber optic sensors from Micro-Epsilon are an optoelectronic sensor solution consisting of a controller and a sensor (sensor head and fiber optic cable). The optoCONTROL CLS1000 controllers are composed of a compact transmitter and receiver unit with integrated signal evaluation. The infrared light is transmitted to the object and back via a high-quality fiber optic cable that works on the principle of total reflection.

The received light intensity is used for evaluation. Due to the large number of sheaths and sensor head variants, the sensors can be adapted to any application and are therefore very versatile in installation. The high-quality fiber optic light guides are characterized by small installation dimensions and robust materials. This makes them particularly suitable for use in harsh ambient conditions such as high temperatures.

General information

Measuring principle / Features	2
Fields of application / Systems	3
Applications	4 - 5
Controller	6 - 13
Sensors	14 - 19

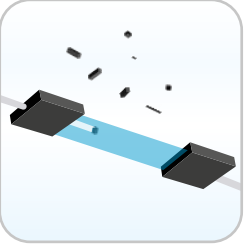
Fields of application

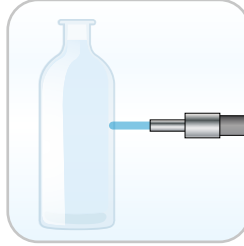
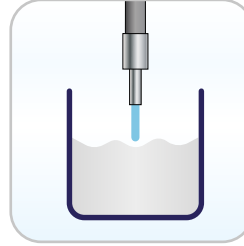
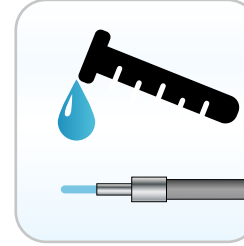
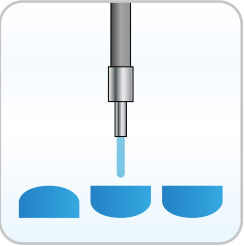
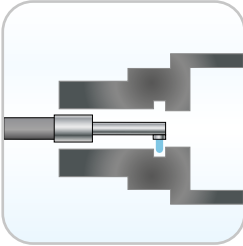
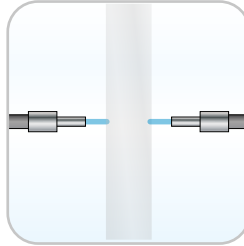
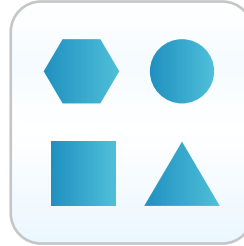
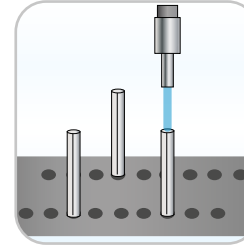
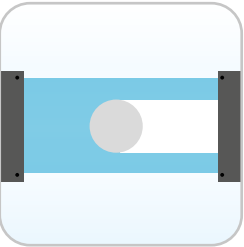
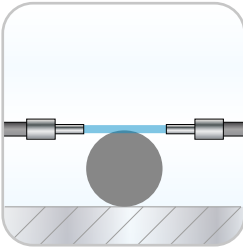
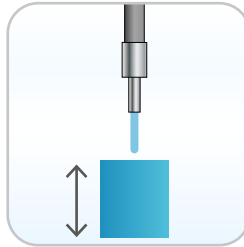
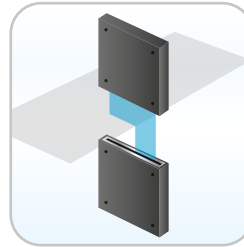
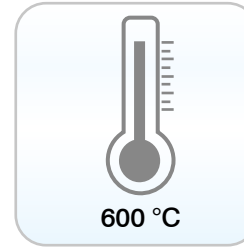
 Area detection	 Use with robots	 LCDs / transparent objects / semiconductors	 Filling level monitoring	 Resistant to oil and chemicals
 Position detection	 Presence detection (e.g. a groove)	 Light barrier	 Shape detection	 Detector (e.g. presence of a pin)
 Distinction of size and diameter	 Tolerance check	 Position determination	 Intensity tests / turbidity / web edge	 600 °C Resistant to heat

Systems

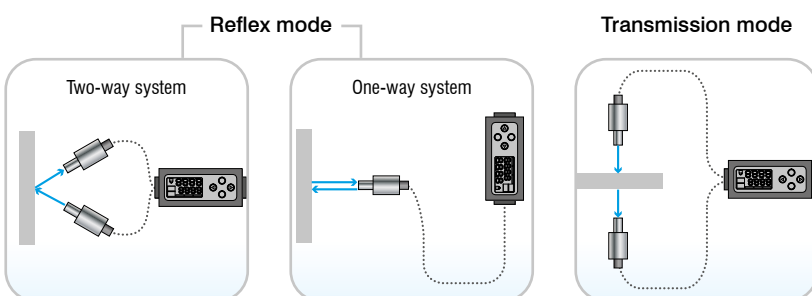

Application examples

optoCONTROL CLS1000

Presence and diameter detection with high temperatures

After the hardening process of steel bars, they are tempered at temperatures of 600 °C to relieve stresses. Optical fiber sensors from Micro-Epsilon are used to quickly determine the presence as well as possible changes in the diameter of the rods. The detection is performed without contact and at a high measuring rate.

Recommended system: CLS1000-AI-NPN + CFS4-C10-E-T400

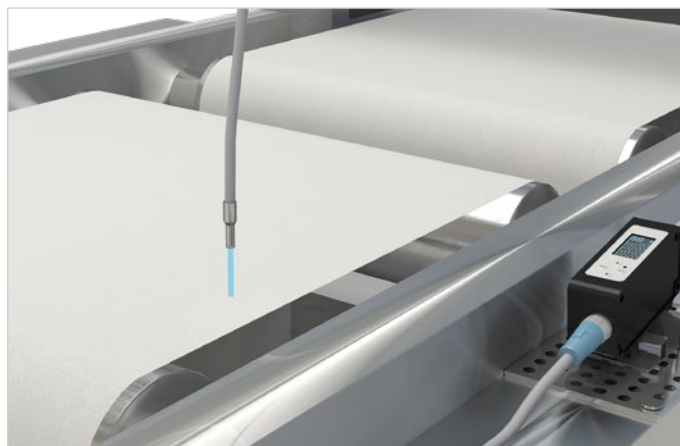
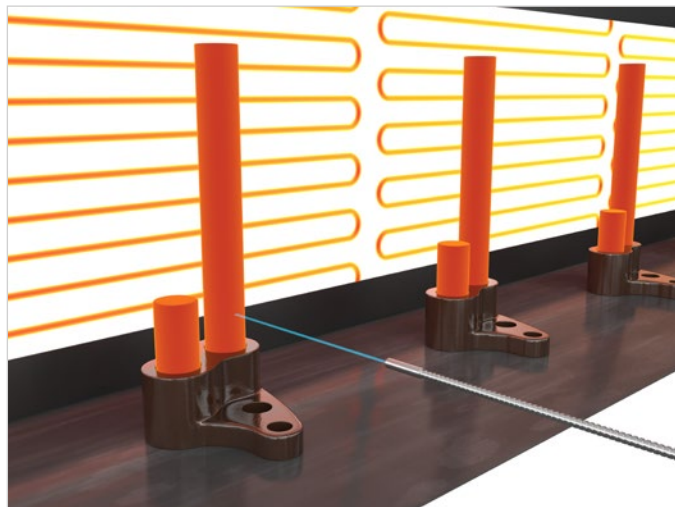

Breakage inspection of belt material

Due to the low response time of 100 μ s, the optoelectronic fiber optic sensors are able to quickly detect disturbances such as breakage of strip materials. Their high switching frequency of 2.5 kHz also enables fast signal output via the analog output. In addition, the high detection range of up to 430 mm allows the sensor to be mounted safely outside the hazardous area.

Recommended system: CLS1000-AU-PP + CFS4-A30

Packaging control of blisters

When packaging tablets in blisters, the presence detection of the medication is required. For this purpose, the fiber optic sensors detect the tablets through the transparent layer of the blister. The challenge here is to capture all pockets of the blister at the high speed at which the belt travels. The system can then filter out incorrectly or insufficiently filled blisters.

Recommended system: CLS1000-QN + CFS4-A11

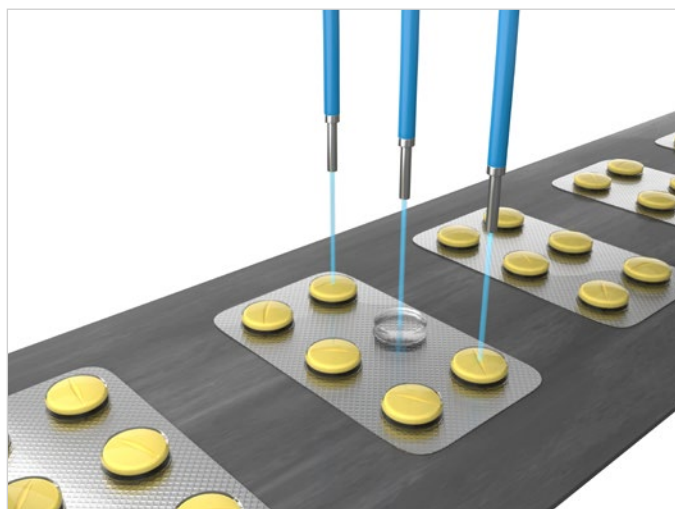

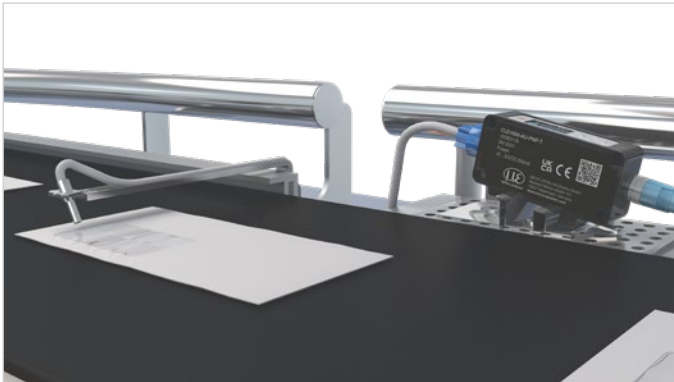

Detection of envelope windows

During the production of envelopes, quality assurance must check whether the window has been inserted. The fiber optic sensors of the optoCONTROL CLS1000 series reliably detect the windows of the envelopes at a frequency of up to 2.5 kHz. The CFS4-A20 sensor is positioned at a distance of 30 mm and an angle of 60° above the window.

Recommended system: CLS1000-2Q + CFS4-A20

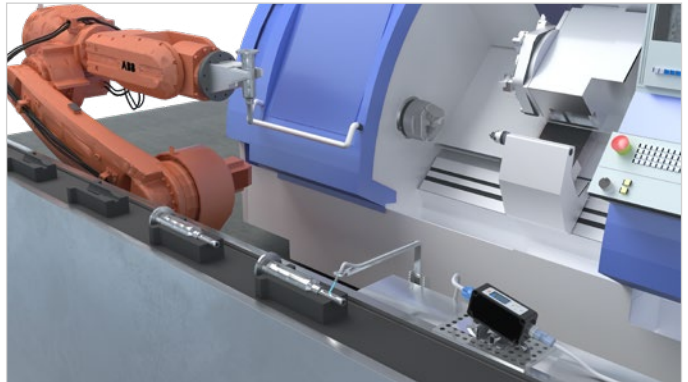

Groove detection on the shaft

After the mechanical processing of shafts, fiber optic sensors from Micro-Epsilon automatically check the required depth and height of the milled groove. For testing, the CLS1000-AU controller is used in combination with the CFS4-A20 sensor. The sensor measures the required depth of 3 mm at a distance of 5 to 8 mm. The output analog signal between 4 ... 20 mA is passed on to the IF2030/ETH interface module.

Recommended system: CLS1000-AU + CFS4-A20



Positioning the film edge

During the winding process or for web inspection of films, film manufacturers rely on sensor technology from Micro-Epsilon. Fiber optic sensors of the type optoCONTROL CLS1000 are used to perform an edge detection of transparent films. Thanks to the wide CFS3-Q5 fiber optic cable, the position of the edge can be reliably detected based on the width.

Recommended system: CLS1000-AU + CFS3-Q5

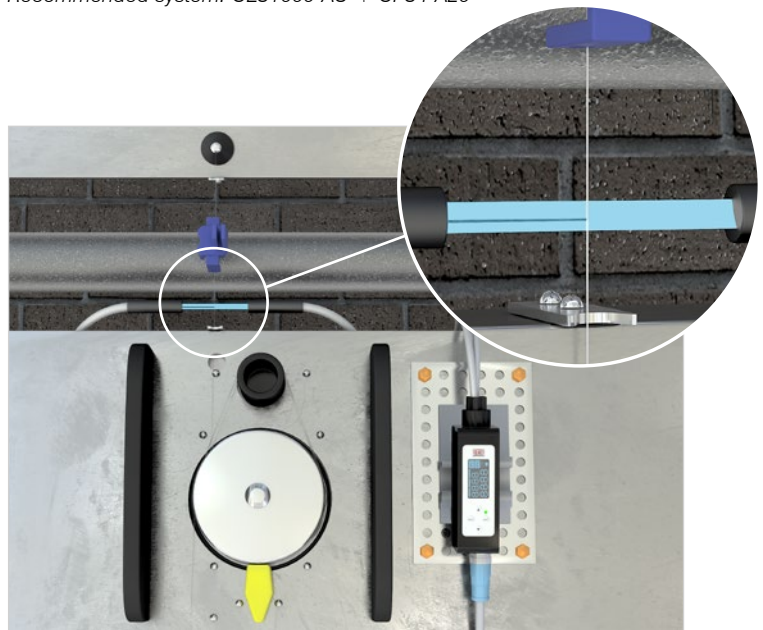







Presence detection of a thread

When texturing threads, the presence of the thread must be continuously checked, as the very thin threads of approx. 80 µm break easily. For presence monitoring, the optoCONTROL CLS1000-AI is used together with the CFS3-R11 sensor. The distance between sensor and receiver is approx. 65 mm. The IF1032 interface module is used to evaluate the output signal at the controller. This setup is also suitable for droplet measurement when detecting leaks.

Recommended system: CLS1000-AI + CFS3-R11

Controller

optoCONTROL CLS1000

-  Large detection and operating ranges
-  Numerous teach-in modes for fast sensor adjustment
-  Detection of finest structures
-  Extremely high resistance to ambient light up to 50,000 lx
-  OLED display for fast and easy configuration
-  Extremely robust and compact
-  Switchable NPN, PNP, PP



Reliable presence detection and position control

The fiber optic sensor comprises a CFS sensor and a CLS1000 controller. The wide detection and operating ranges of up to 2000 mm make the fiber optic sensor ideal for the detection of components even at great distances.

The optoCONTROL CLS1000 optoelectronic fiber optic sensor is suitable for use in automation thanks to its variable switching outputs. The fiber optic sensor is used, for example, in position control and for position and presence detection.

The CLS1000 controller is available in five different versions: CLS1000-QN with antivalence function (normally open/ normally closed), CLS1000-2Q with two switching outputs, CLS1000-OC with optocoupler, CLS1000-AU with voltage output and CLS1000-AI with current output. Each model is available in NPN, PNP or push-pull versions, each with or without trigger.

Due to the high resistance to ambient light and the possibility to adapt the controller in OEM applications, the CLS1000 can be used in almost all environments, whether high temperatures or confined installation spaces.

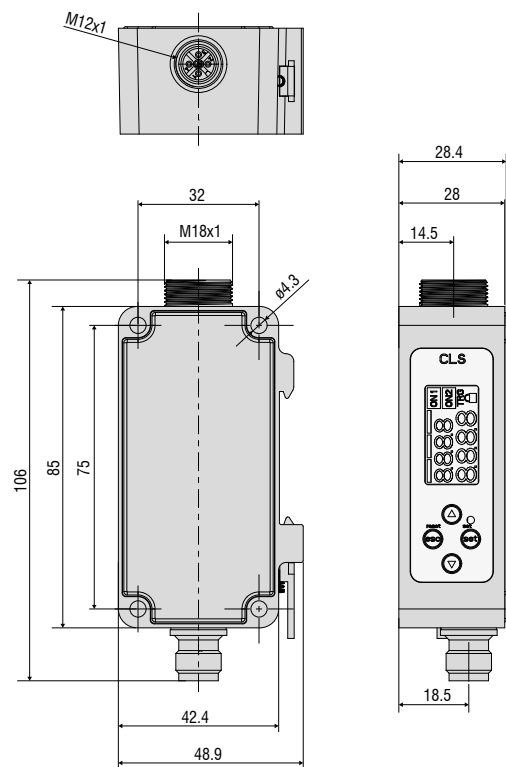

(dimensions in mm, not to scale)

OLED Display / Control Panel

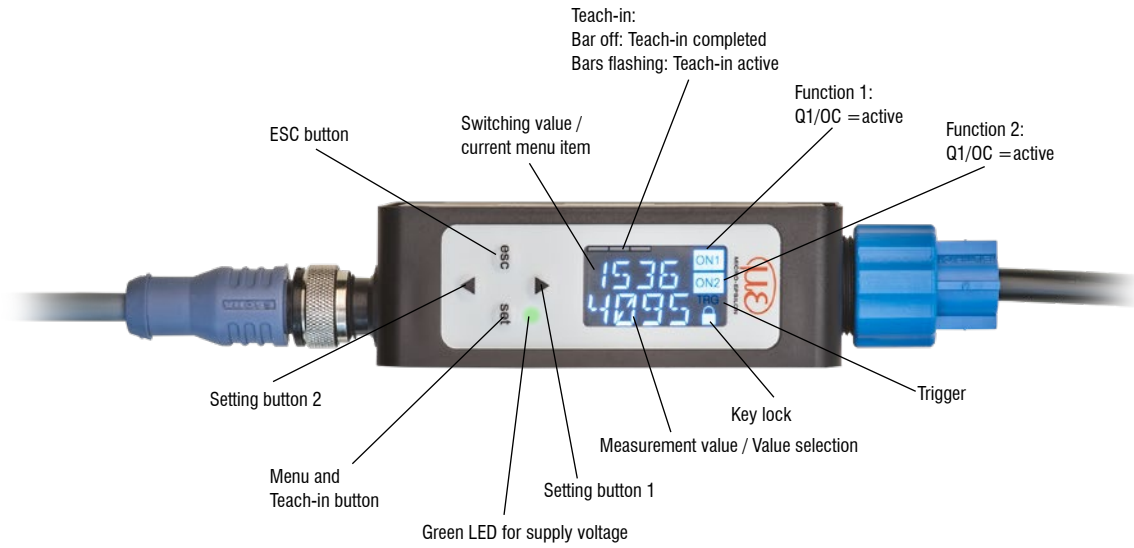

Controller variants

Controller with two switching outputs optoCONTROL CLS1000-2Q

- Two independently adjustable switching outputs
- Two individual switching thresholds

Controller with optocoupler optoCONTROL CLS1000-OC

- Optocoupler output for potential-free switching
- Galvanic isolation of the output circuitry

Controller with voltage output optoCONTROL CLS1000-AU

- Freely scalable analog output
Voltage from 0 ... 10 V
- Analog output as intensity output
- Analog output and switching output

Controller with antivalence function optoCONTROL CLS1000-QN

- Two antivalent switching outputs: Q and QN
- Wire breakage protection thanks to antivalent switching output

Controller with current output optoCONTROL CLS1000-AI

- Freely scalable analog output current
from 0 ... 20 mA or 4 ... 20 mA
- Analog output as intensity output
- Analog output and switching output



Controller

optoCONTROL CLS1000

Type	Switching output is switchable			Analog output			Trigger	Switching type (switchable)		Connection		Page
	NPN	PNP	PP	0 ... 10 V	0 ... 20 mA	4 ... 20 mA		light switching	dark switching	4-pole M12 socket	5-pole M12 socket	
Controller												
CLS1000-QN-NPN	x	x	x					x	x	x		9
CLS1000-QN-NPN-T	x	x	x				x	x	x		x	9
CLS1000-QN-PNP	x	x	x					x	x	x		9
CLS1000-QN-PNP-T	x	x	x				x	x	x		x	9
CLS1000-QN-PP	x	x	x					x	x	x		9
CLS1000-QN-PP-T	x	x	x				x	x	x		x	9
CLS1000-2Q-NPN	x	x	x					x	x	x		10
CLS1000-2Q-NPN-T	x	x	x				x	x	x		x	10
CLS1000-2Q-PNP	x	x	x					x	x	x		10
CLS1000-2Q-PNP-T	x	x	x				x	x	x		x	10
CLS1000-2Q-PP	x	x	x					x	x	x		10
CLS1000-2Q-PP-T	x	x	x				x	x	x		x	10
CLS1000-OC								x	x	x		11
CLS1000-OC-T							x	x	x		x	11
CLS1000-AU-NPN	x	x	x	x				x	x	x		12
CLS1000-AU-NPN-T	x	x	x	x			x	x	x		x	12
CLS1000-AU-PNP	x	x	x	x				x	x	x		12
CLS1000-AU-PNP-T	x	x	x	x			x	x	x		x	12
CLS1000-AU-PP	x	x	x	x				x	x	x		12
CLS1000-AU-PP-T	x	x	x	x			x	x	x		x	12
CLS1000-AI-NPN	x	x	x		x	x		x	x	x		13
CLS1000-AI-NPN-T	x	x	x		x	x	x	x	x		x	13
CLS1000-AI-PNP	x	x	x		x	x		x	x	x		13
CLS1000-AI-PNP-T	x	x	x		x	x	x	x	x		x	13
CLS1000-AI-PP	x	x	x		x	x		x	x	x		13
CLS1000-AI-PP-T	x	x	x		x	x	x	x	x		x	13

x = Switching output set at the factory

x = Switching output can be optionally switched via the menu

Controller with antivalence function optoCONTROL CLS1000-QN



Two antivalent switching outputs
Q and QN

Switchable NPN, PNP, PP

Wire breakage protection thanks
to antivalent switching output

Model	CLS1000-QN-NPN	CLS1000-QN-PNP	CLS1000-QN-PP	CLS1000-QN-NPN-T	CLS1000-QN-PNP-T	CLS1000-QN-PP-T
Article number	10085101	10085102	10085103	10085104	10085105	10085106
Operating range	max. 2000 mm (depending on transmission sensor)					
Detection range	max. 1200 mm (depending on reflex sensor)					
Response time	100 μ s					
Switching frequency	2.5 kHz (depending on pulse/pause ratio)					
Temperature stability	$\leq 0.1\%$ FSO / K					
Light source	infrared LED 870 nm					
Permissible ambient light	50,000 lx					
Supply voltage ¹⁾	12 ... 30 VDC					
Max. current consumption	50 mA					
Switching output	switchable NPN; PNP; PP	2x NPN normally open/ normally closed (Q/QN; NO/NC)	2x PNP normally open/ normally closed (Q/QN; NO/NC)	2x PP normally open/ normally closed (Q/QN; NO/NC)	2x NPN normally open/ normally closed (Q/QN; NO/NC)	2x PNP normally open/ normally closed (Q/QN; NO/NC)
Switching	light/dark switching (switchable)					
Signal input	-			Trigger In		
Connection	Optical	FA socket M18x1 for screwable optical fiber (length 0.3 m ... 15 m, min. bending radius 18 mm)				
	Electrical	4-pin M12 socket for power supply and signals (connection cable see accessories)			5-pin socket M12 for power supply and signals (connection cable see accessories)	
Mounting	DIN rail mounting, mounting adapter, (see accessories), mounting holes					
Temperature range	Storage	-10 ... +70°C				
	Operation	-5 ... +55°C				
Shock (DIN EN 60068-2-27)	20 g / 11 ms in 3 axes, two directions and 1000 shocks each					
Vibration (DIN EN 60068-2-6)	15 g / 10 ... 1000 Hz in 3 axes, 10 cycles each					
Protection class (DIN EN 60529)	IP67					
Material	Plastic housing (polycarbonate)					
Weight	200 g					
Compatibility	with all CFS sensors (FAR, FAD, FAZ and FAS)					
Control and indicator elements	Parameterization/operation via membrane keypad and OLED display on controller; LED for power on					
Special features	up to 7 teach-in modes; adjustable switching output functions on-delayed and off-delayed as well as pulse output; adjustable hysteresis 2 ... 25 %			up to 7 teach-in modes; adjustable switching output functions on-delay and off-delay as well as pulse output; adjustable hysteresis 2 ... 25%; variety of trigger types		

FSO = Full Scale Output

The specified data apply for a consistent room temperature of 22 °C, sensor is continuously in operation, open signal outputs.

¹⁾ Residual ripple $\leq 10\%$

Connection diagram

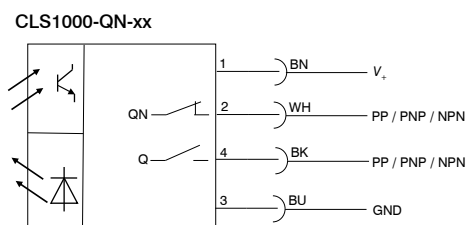

CLS1000-QN-xx-T

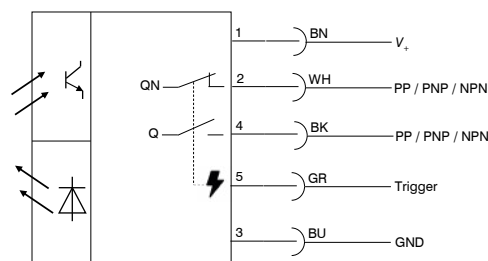

Controller with two switching outputs

optoCONTROL CLS1000-2Q

Two independently adjustable switching outputs

Two individual switching thresholds



Model	CLS1000-2Q-NPN	CLS1000-2Q-PNP	CLS1000-2Q-PP	CLS1000-2Q-NPN-T	CLS1000-2Q-PNP-T	CLS1000-2Q-PP-T	
Article number	10085107	10085108	10085109	10085110	10085111	10085112	
Operating range	max. 2000 mm (depending on transmission sensor)						
Detection range	max. 1200 mm (depending on reflex sensor)						
Response time	100 μ s						
Switching frequency	2.5 kHz (depending on pulse/pause ratio)						
Temperature stability	≤ 0.1 % FSO / K						
Light source	infrared LED 870 nm						
Permissible ambient light	50,000 lx						
Supply voltage ¹⁾	12 ... 30 VDC						
Max. current consumption	50 mA						
Switching output	each switchable NPN; PNP; PP	2x NPN (Q1/Q2)	2x PNP (Q1/Q2)	2x PP (Q1/Q2)	2x NPN (Q1/Q2)	2x PNP (Q1/Q2)	
Switching	light/dark switching (switchable)						
Signal input	Trigger In						
Connection	Optical	FA socket M18x1 for screwable optical fiber (length 0.3 m ... 15 m, min. bending radius 18 mm)					
	Electrical	4-pin M12 socket for power supply and signals (connection cable see accessories)			5-pin socket M12 for power supply and signals (connection cable see accessories)		
Mounting	DIN rail, mounting rail (see accessories), mounting holes						
Temperature range	Storage	-10 ... +70°C					
	Operation	-5 ... +55°C					
Shock (DIN EN 60068-2-27)	20 g / 11 ms in 3 axes, two directions and 1000 shocks each						
Vibration (DIN EN 60068-2-6)	15 g / 10 ... 1000 Hz in 3 axes, 10 cycles each						
Protection class (DIN EN 60529)	IP67						
Material	Plastic housing (polycarbonate)						
Weight	200 g						
Compatibility	with all CFS sensors (FAR, FAD, FAZ and FAS)						
Control and indicator elements	Parameterization/operation via membrane keypad and OLED display on controller; LED for power on						
Special features	up to 7 teach-in modes; adjustable switching output functions on-delayed and off-delayed as well as pulse output; adjustable hysteresis 2 ... 25 %			up to 7 teach-in modes; adjustable switching output functions on-delay and off-delay as well as pulse output; adjustable hysteresis 2 ... 25%; variety of trigger types			

FSO = Full Scale Output

The specified data apply for a consistent room temperature of 22 °C, sensor is continuously in operation, open signal outputs.

¹⁾ Residual ripple $\leq 10\%$

Connection diagram

CLS1000-2Q-xx

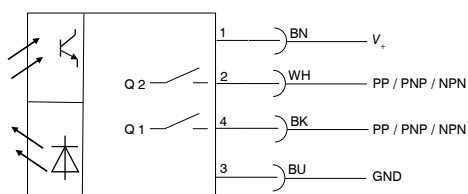

CLS1000-2Q-xx-T

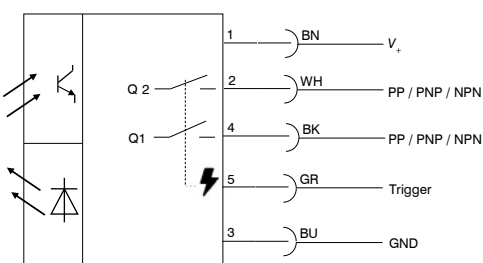

Controller with optocoupler optoCONTROL CLS1000-OC



Optocoupler output for potential-free switching

Galvanic isolation of the output circuit

Model	CLS1000-OC	CLS1000-OC-T	
Article number	10085113	10085114	
Operating range	max. 2000 mm (depending on transmission sensor)		
Detection range	max. 1200 mm (depending on reflex sensor)		
Response time	100 μ s		
Switching frequency	2.5 kHz (depending on pulse/pause ratio)		
Temperature stability	$\leq 0.1\%$ FSO / K		
Light source	infrared LED 870 nm		
Permissible ambient light	50,000 lx		
Supply voltage ¹⁾	12 ... 30 VDC		
Max. current consumption	50 mA		
Switching output	Optocoupler (OC)		
Switching	light/dark switching (switchable)		
Signal input	-	Trigger In	
Connection	Optical	FA socket M18x1 for screwable optical fiber (length 0.3 m ... 15 m, min. bending radius 18 mm)	
	Electrical	4-pin M12 socket for power supply and signals (connection cable see accessories)	5-pin socket M12 for power supply and signals (connection cable see accessories)
Mounting	DIN rail, mounting rail (see accessories), mounting holes		
Temperature range	Storage	-10 ... +70 °C	
	Operation	-5 ... +55 °C	
Shock (DIN EN 60068-2-27)	20 g / 11 ms in 3 axes, two directions and 1000 shocks each		
Vibration (DIN EN 60068-2-6)	15 g / 10 ... 1000 Hz in 3 axes, 10 cycles each		
Protection class (DIN EN 60529)	IP67		
Material	Plastic housing (polycarbonate)		
Weight	200 g		
Compatibility	with all CFS sensors (FAR, FAD, FAZ and FAS)		
Control and indicator elements	Parameterization/operation via membrane keypad and OLED display on controller; LED for power on		
Special features	up to 7 teach-in modes; adjustable switching output functions on-delayed and off-delayed as well as pulse output; adjustable hysteresis 2 ... 25 %	up to 7 teach-in modes; adjustable switching output functions on-delay and off-delay as well as pulse output; adjustable hysteresis 2 ... 25%; variety of trigger types	

FSO = Full Scale Output

The specified data apply for a consistent room temperature of 22 °C, sensor is continuously in operation, open signal outputs.

¹⁾ Residual ripple $\leq 10\%$

Connection diagram

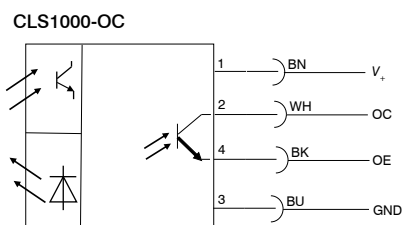

CLS1000-OC-T

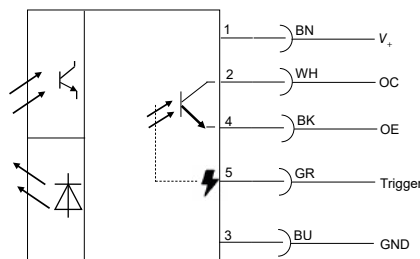

Controller with voltage output opto**CONTROL** CLS1000-AU

Freely scalable analog output
Voltage from 0 ... 10 V

Analog output as intensity
output

Analog output and switching output



Model	CLS1000-AU-NPN	CLS1000-AU-PNP	CLS1000-AU-PP	CLS1000-AU-NPN-T	CLS1000-AU-PNP-T	CLS1000-AU-PP-T
Article number	10085115	10085116	10085117	10085118	10085119	10085120
Operating range	max. 2000 mm (depending on transmission sensor)					
Detection range	max. 1200 mm (depending on reflex sensor)					
Response time	100 μ s					
Switching frequency	2.5 kHz (depending on pulse/pause ratio)					
Frequency response (-3dB)	10 kHz					
Temperature stability	$\leq 0.1\%$ FSO / K					
Light source	infrared LED 870 nm					
Permissible ambient light	50,000 lx					
Supply voltage ¹⁾	12 ... 30 VDC					
Max. current consumption	50 mA					
Analog output	0 ... 10 V					
Switching output	NPN	PNP	PP	NPN	PNP	PP
Switching	light/dark switching (switchable)					
Signal input	-			Trigger In		
Connection	Optical	FA socket M18x1 for screwable optical fiber (length 0.3 m ... 15 m, min. bending radius 18 mm)				
	Electrical	4-pin M12 socket for power supply and signals (connection cable see accessories)			5-pin socket M12 for power supply and signals (connection cable see accessories)	
Mounting	DIN rail, DIN rail mounting (see accessories), mounting holes					
Temperature range	Storage	-10 ... +70°C				
	Operation	-5 ... +55°C				
Shock (DIN EN 60068-2-27)	20 g / 11 ms in 3 axes, two directions and 1000 shocks each					
Vibration (DIN EN 60068-2-6)	15 g / 10 ... 1000 Hz in 3 axes, 10 cycles each					
Protection class (DIN EN 60529)	IP67					
Material	Plastic housing (polycarbonate)					
Weight	200 g					
Compatibility	with all CFS sensors (FAR, FAD, FAZ and FAS)					
Control and indicator elements	Parameterization/operation via membrane keypad and OLED display on controller; LED for power on					
Special features	up to 9 teach-in modes; adjustable switching output functions on-delay and off-delay as well as pulse output adjustable hysteresis 2 ... 25%			up to 9 teach-in modes; adjustable switching output functions on-delay and off-delay as well as pulse output adjustable hysteresis 2 ... 25%; variety of trigger types		

FSO = Full Scale Output

The specified data apply for a consistent room temperature of 22 °C, sensor is continuously in operation, open signal outputs.

¹⁾ Residual ripple $\leq 10\%$

Connection diagram

CLS1000-AU-xx

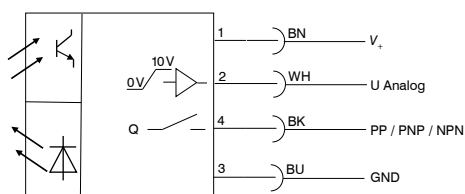

CLS1000-AU-xx-T

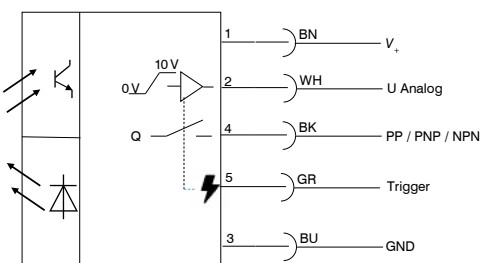

Controller with current output optoCONTROL CLS1000-AI



Freely scalable analog output current
from 0 ... 20 or 4 ... 20 mA

Analog output as intensity
output

Analog output and switching output

Model	CLS1000-AI-NPN	CLS1000-AI-PNP	CLS1000-AI-PP	CLS1000-AI-NPN-T	CLS1000-AI-PNP-T	CLS1000-AI-PP-T
Article number	10085121	10085122	10085123	10085124	10085125	10085126
Operating range	max. 2000 mm (depending on transmission sensor)					
Detection range	max. 1200 mm (depending on reflex sensor)					
Response time	100 μ s					
Switching frequency	2.5 kHz (depending on pulse/pause ratio)					
Frequency response (-3dB)	10 kHz					
Temperature stability	$\leq 0.1\%$ FSO / K					
Light source	infrared LED 870 nm					
Permissible ambient light	50,000 lx					
Supply voltage ¹⁾	12 ... 30 VDC					
Max. current consumption	50 mA					
Analog output	switchable 0 ... 20 mA or 4 ... 20 mA					
Switching output	NPN	PNP	PP	NPN	PNP	PP
Switching	light/dark switching (switchable)					
Signal input	-			Trigger In		
Connection	Optical	FA socket M18x1 for screwable optical fiber (length 0.3 m ... 15 m, min. bending radius 18 mm)				
	Electrical	4-pin M12 socket for power supply and signals (connection cable see accessories)			5-pin socket M12 for power supply and signals (connection cable see accessories)	
Mounting	DIN rail, DIN rail mounting (see accessories), mounting holes					
Temperature range	Storage	-10 ... +70°C				
	Operation	-5 ... +55°C				
Shock (DIN EN 60068-2-27)	20 g / 11 ms in 3 axes, two directions and 1000 shocks each					
Vibration (DIN EN 60068-2-6)	15 g / 10 ... 1000 Hz in 3 axes, 10 cycles each					
Protection class (DIN EN 60529)	IP67					
Material	Plastic housing (polycarbonate)					
Weight	200 g					
Compatibility	with all CFS sensors (FAR, FAD, FAZ and FAS)					
Control and indicator elements	Parameterization/operation via membrane keypad and OLED display on controller; LED for power on					
Special features	up to 9 teach-in modes; adjustable switching output functions on-delay and off-delay as well as pulse output adjustable hysteresis 2 ... 25%			up to 9 teach-in modes; adjustable switching output functions on-delay and off-delay as well as pulse output adjustable hysteresis 2 ... 25%; variety of trigger types		

FSO = Full Scale Output

The specified data apply for a consistent room temperature of 22 °C, sensor is continuously in operation, open signal outputs.

¹⁾ Residual ripple $\leq 10\%$

Connection diagram

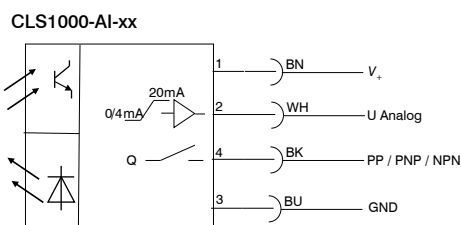

CLS1000-AI-xx-T

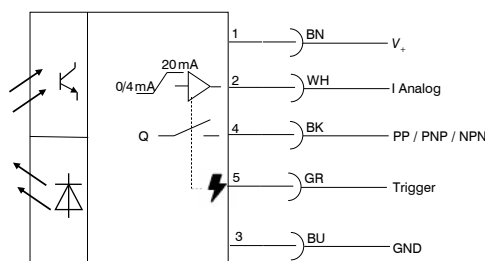

Fiber optic sensors optoCONTROL CFS

Customer-specific adaptations are possible for all sensors.
We would be pleased to manufacture your sensor according to your drawing.
Please contact us directly for more information!

Examples of customer-specific modifications

Function

- Special types for CFS4 reflex sensor
- Special types for transmission sensor CFS3

Optical fiber sheath

- Silicone-metal sheath
- VA stainless-steel sheath
- Metal sheath
- PVC metal sheath
- PVC special sheath
- BOA special sheath
- MA-radius-limiting special sheath

Fiber bundle diameter

- 0.6 / 1 / 1.5 / 2.5 / 3 mm

Optical fiber (length)

- Available from 300 mm
- Standard length 1,200 mm
- 600, 1,800 and 2,400 mm optionally available
- Individual length of 0.3 ... 2.4 m possible

Aperture angle

- Standard 67°
- Optional 22° / 35°

Ambient conditions

- Special versions with increased vibration resistance (VS)
- Special variants with special bonding for high temperatures (T250 / T400)
- Pressure-tight special variants with vacuum feed-through (up to 10^{-5} mbar)

Sensor heads

- Sensor heads with straight output
- 90° output for confined installation spaces
- Sensor head with wide light band (width between 5 to 88 mm)
- Sensor heads with and without external thread
- Thin sensor heads with bendable head

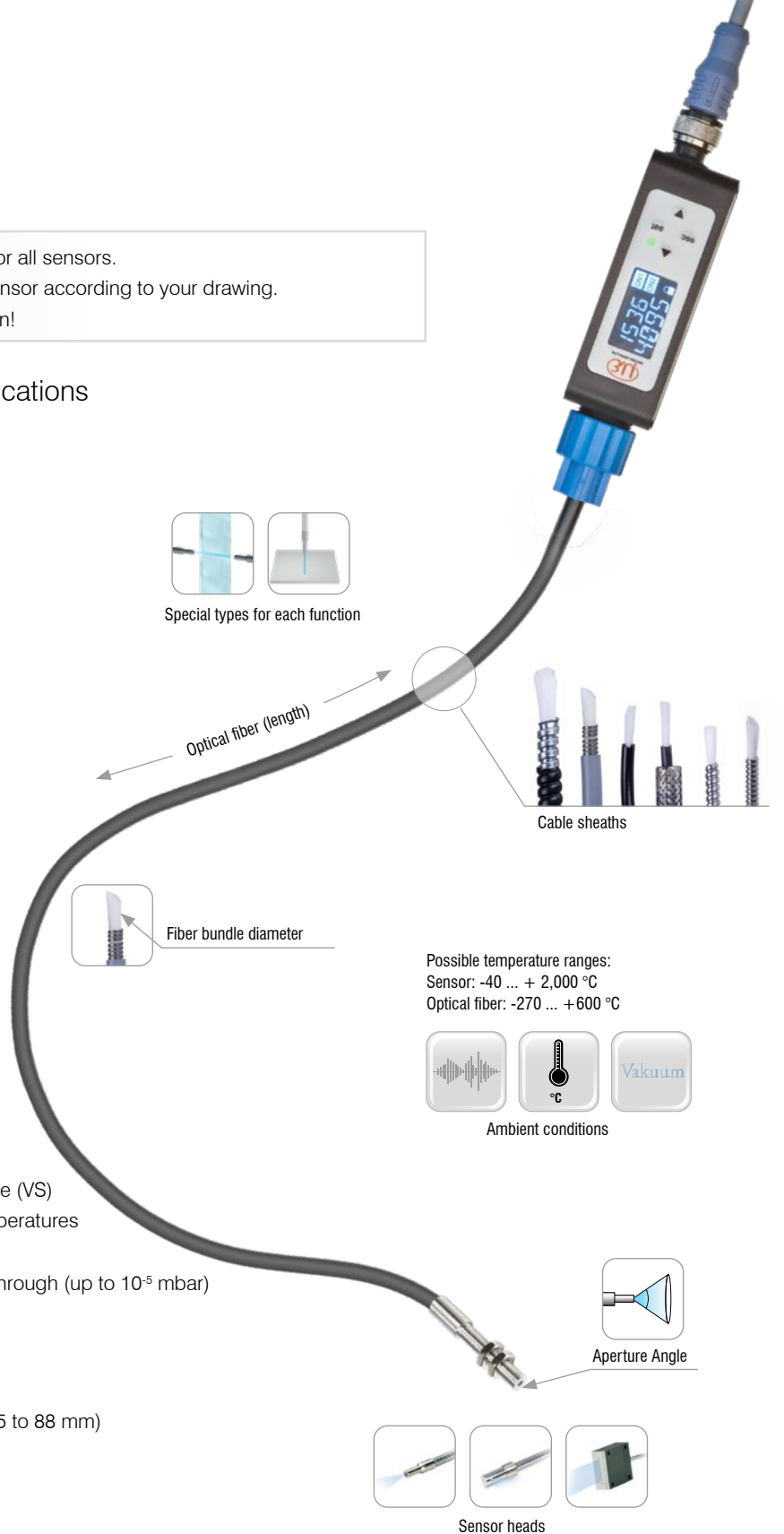

Vacuum suitability

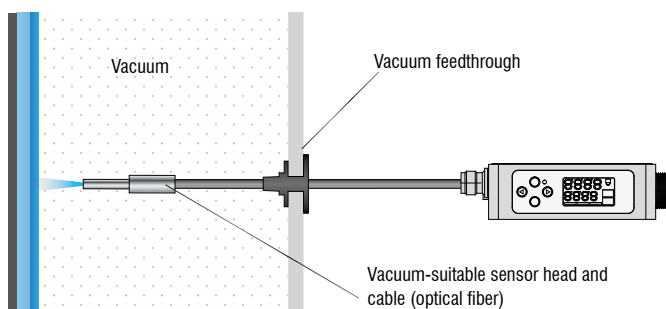

The fiber optic sensors and fiber optic cables are built with passive components and do not emit heat to the environment. In vacuum, sensors (temperature bonding T250), optical fibers (stainless steel sheath), and the vacuum feed-through up to 10^{-5} mbar can be used.

Surface-dependent range

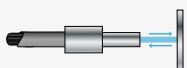
 Range Transmitted light mode (typ.)		90 mm	200 mm	500 mm	1700 mm	2000 mm
Min. object size (typ.)		0.05 mm	0.1 mm	0.1 mm	0.2 mm	0.3 mm
 Range Reflex mode (typ.) *	copper	35 mm	76 mm	217 mm	820 mm	> 1200 mm
	raw aluminum	24 mm	61 mm	164 mm	514 mm	457 mm
	stainless steel	21 mm	50 mm	135 mm	412 mm	415 mm
	white, rough plastics	13 mm	33 mm	84 mm	260 mm	260 mm
	mat black cardboard	6 mm	16 mm	44 mm	130 mm	135 mm
Required fiber bundle øF		0.6 mm	1 mm	1.5 mm	2.5 mm	3 mm

*Analog output 5V and max. gain

Notes on the function of the CFS sensors

Application instructions on selecting the appropriate function.



Reflex mode (One-way system)

- Detection range max. 1200 mm
- Easy and fast installation
- Detection of finest structures
- Presence detection
- Ideal for level monitoring, position and location determination

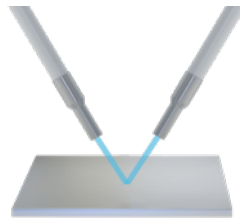

Reflex mode V-arrangement (Two-way system)

- Detection range max. 1200 mm
- Very exact positioning of the switching point
- 2 objects generate highest intensity on the intersection
- Suitable for light dust and particles flying in the path of the beam

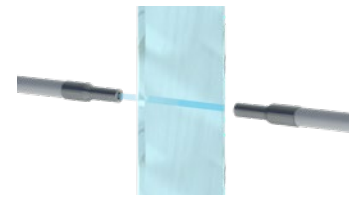

Transmission mode (Two-way system)

- Large distance between receiving and transmission unit up to 2000 mm
- Objects are detected by interruption of light beam
- Arbitrary point of light transmission
- Detection of transparent objects
- Ideal for part recognition, counting tasks, edge detection, presence monitoring

Special types

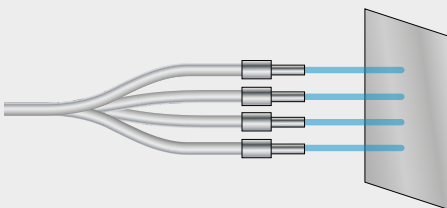

For multiple reflex mode

Transmitting and receiving units are statistically mixed in two or more separate sensor heads. Therefore, several positions can be detected using only one sensor.







For transmission mode

The light path of the axially opposite sensor heads is interrupted or attenuated by one or more objects.

Transmission sensor for translucent objects

optoCONTROL CFS3

-  Large operating range between receiver and transmitter unit with up to 2000 mm
-  No exact positioning of the measuring object necessary
-  Simple and space-saving mounting
-  Models with and without external thread

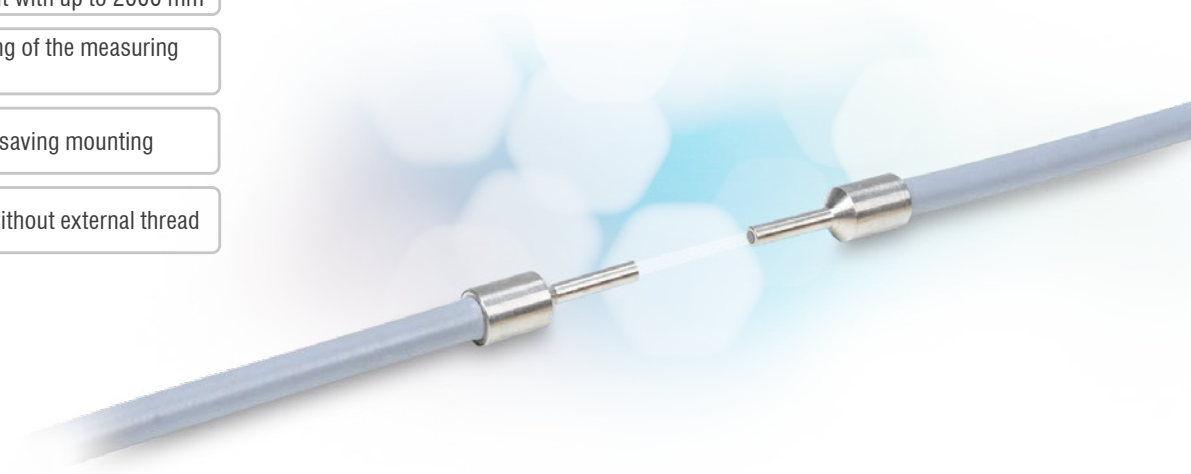

With the transmission sensor, the infrared light emitted by the controller is guided via the optical fiber to the transmitter and from there to the detecting object. There, the light beam is either interrupted or transmitted, depending on the target. The receiving unit of the sensor receives the remaining light and sends it back to the controller via the optical fiber. The remaining light component consists of either the unshielded light component or light transmitted from the object. By illuminating the transmitter through the object, it is possible to detect levels of liquids in jars as well as transparent objects. In addition to detecting transparent and semi-transparent objects, the sensor arrangement of the transmission sensor in transmitted light (180:0) is ideally suited for area detection, as a light barrier, for distinguishing sizes and diameters, for tolerance inspection and for web edge detection.

The CFS4 sensors, in combination with the performance of the CLS1000 series, provide reliable results. Here, the distance variation between the test specimen and receiver or illumination has no noticeable influence on the result. The transmission sensor can be universally used but is also suitable for special solutions (customer-specific adaptations).

The sensors are available with different operating ranges, temperature ranges and lengths. This enables a wide range of applications. The fiber optic cable has a sensor head, which is available in different versions:

With external thread: For example, threaded sensors can be easily fixed on a mounting bracket.

Without external thread: Cylindrical sensor heads are suitable for space-saving mounting. This is achieved by simply setting a grub screw.

Measurement geometry

Transmission sensor 0°:180°

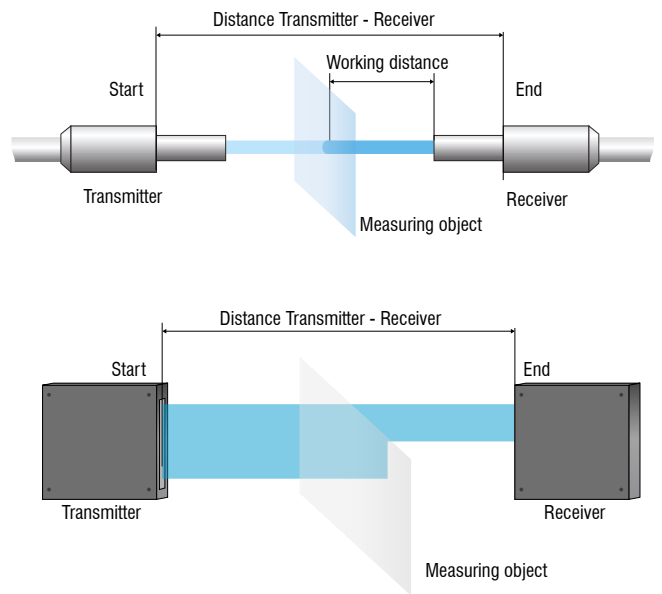

Transmission sensor with transmitter and receiver

90° deflection: If the installation depth and the mounting space are very limited, sensors with integrated 90° deflection are the optimal solution.

Flat sensor head: Thanks to the light band, flat sensor heads are ideal for distinguishing sizes and diameters, monitoring web edges, and area detection.

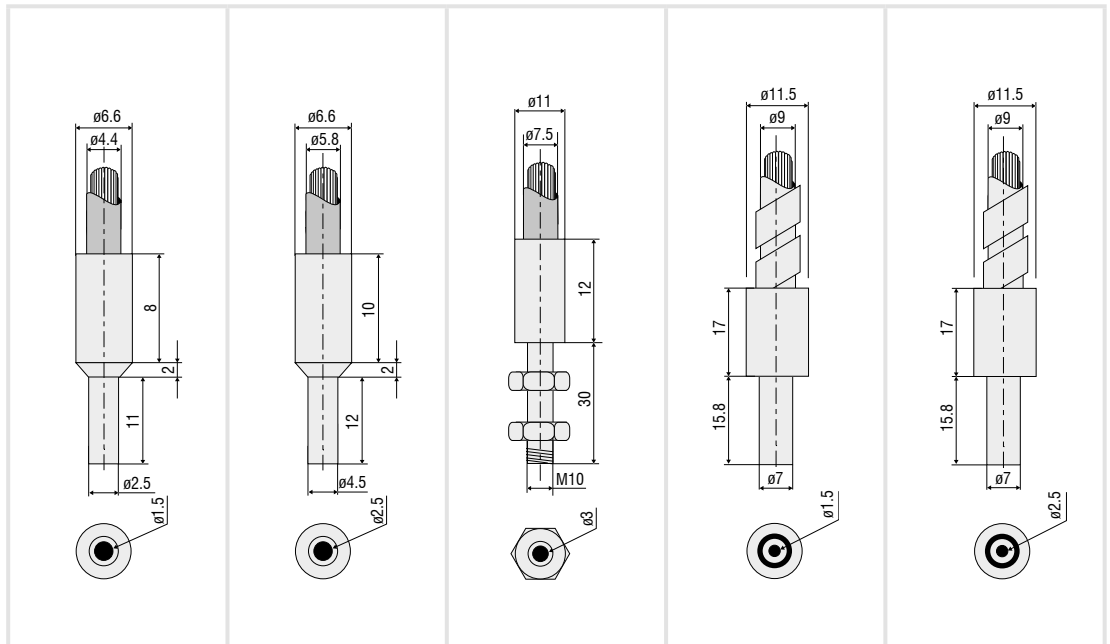





Model	CFS3-A11	CFS3-A20	CFS3-C30	CFS3-M12-600	CFS3-M20-M	
Article number	10810518	10810490	10811921	10810353	10810438	
Sensor type	Transmission sensor					
Operating range (transmitter-receiver distance)	Start	1 mm				
	End	500 mm	1700 mm	2000 mm	90 mm	200 mm
Working distance (measuring object - receiver)	Measuring object can be freely positioned between transmitter and receiver					
Measurement geometry	0°:180°					
Min. target size ¹⁾	Ø0.1 µm	Ø0.2 µm	Ø0.3 µm	Ø0.05 µm	Ø0.1 µm	
Connection	Screwable fiber optic cable via FA socket (M18x1),					
	Standard length 1.2 m; max. bending radius 13.2 mm	Standard length 1.2 m; max. bending radius 17.4 mm	Standard length 1.2 m; max. bending radius 22.5 mm	Length 0.6 m; max. bending radius 13.2 mm	Standard length 1.2 m; max. bending radius 15 mm	
Mounting	FA (M18x1)					
Temperature range	Storage	Sensor head: -10 ... +80 °C; Optical fiber: -60 ... +180 °C			Sensor head: -10 ... +80 °C	
	Operation				Fiber optic cable: -40 ... +300 °C	
Humidity (non-condensing)	20 ... 80 % r.H.				20 ... 60 % r.H.	
Protection class (DIN EN 60529)	IP64				IP40	
Material	Sensor head	Stainless steel				
	Optical fiber	integrated glass fiber (Ø1.5 mm) and metal-silicone (T) sheathing	integrated glass fiber (Ø2.5 mm) and metal-silicone (T) sheathing	integrated glass fiber (Ø3.0 mm) and metal-silicone (T) sheathing	integrated glass fiber (Ø0.6 mm) and metal-silicone (T) sheathing	integrated glass fiber (Ø1.0 mm) and brass spiral hose chrome-plated (M)
Weight	90 g	160 g	280 g	48 g	100 g	
Compatibility	compatible with all CLS and CFO controllers					
Special features	All variants are also available with different sheath, length 0.3 ... 10 m, vibration protection, IP protection, suitable for drag chains and available for temperature ranges up to 2,000 °C. In combination with a pressure-tight feed-through, a stainless steel sheath and T250° bonding, vacuum applications down to 10 ⁻⁵ mbar are also possible.					

¹⁾ These values apply over the entire operating range. Except the middle of the distance between the transmitter and receiver

Reflex sensor for the distinction of materials and parts

optoCONTROL CFS4

-  Detection range up to 430 mm
-  Options with light band and 90° output
-  Simple and space saving mounting
-  Models with and without external thread



In the case of the reflex sensor, the infrared light emitted by the controller is guided to the detecting object via the sensor's fiber-optic light guides and reflected there. Both diffuse and directly reflected components are present in the back-reflected infrared light. The reflected light components of the object to be detected are received by the same sensor and transmitted back to the controller via the optical fiber for evaluation.

The high-quality reflective sensor, in combination with the performance of the CLS1000 series, delivers even more precise detection of a wide variety of objects and structures. The sensors are available with a wide range of detection ranges, temperature ranges and lengths. This enables a wide range of applications. The fiber optic cable has a sensor head, which is available in different versions:

With external thread: For example, threaded sensors can be easily fixed on a mounting bracket.

Without external thread: Cylindrical sensor heads are suitable for space-saving mounting. This is achieved by simply setting a grub screw.

90° deflection: If the installation depth and the mounting space are very limited, sensors with integrated 90° deflection are the optimal solution.

Flat sensor head: Thanks to the light band, flat sensor heads are best suited for detecting larger objects. These can be located anywhere in the light band.

Measurement geometry

Reflex sensor 0°:0°

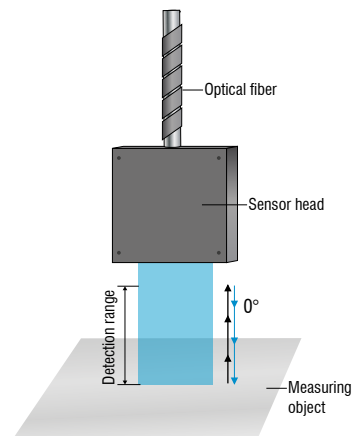
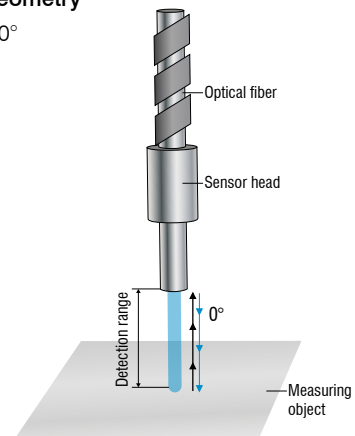

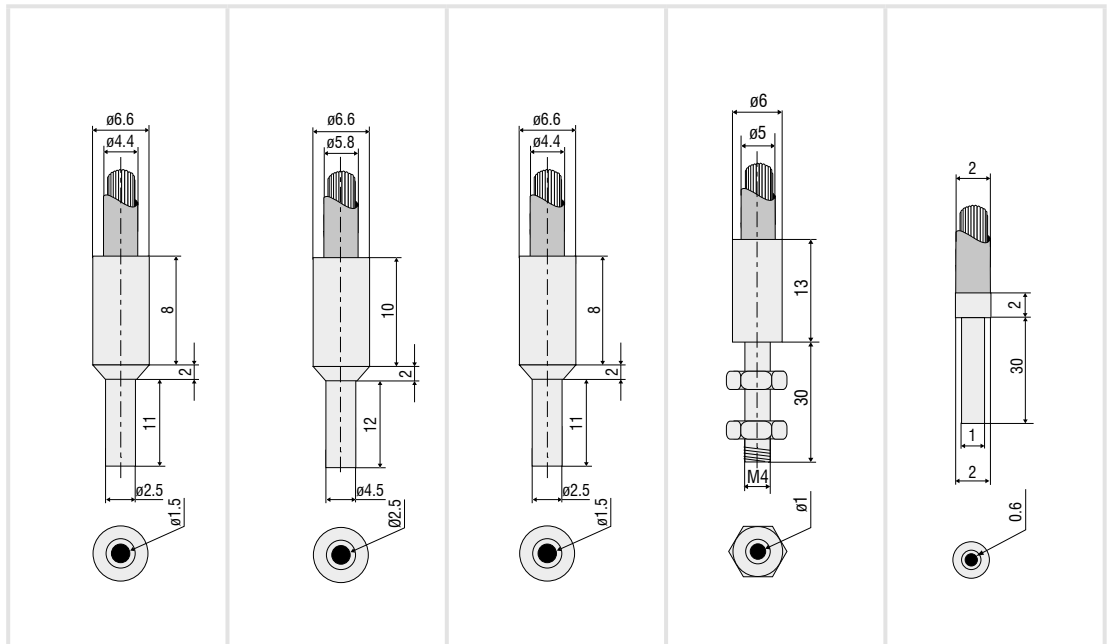

Model	CFS4-A11	CFS4-A20	CFS4-A30	CFS4-C10-M	CFS4-B11-P	
Article number	10810487	10810351	10810584	10810383	10810254	
Sensor type	Reflex sensor					
Detection range ¹⁾	Start	1 mm	1 mm	1 mm	1 mm	
	End	132 mm	394 mm	430 mm	50 mm	19 mm
Measurement geometry	0°:0°					
Connection	Screwable fiber optic cable via FA socket (M18x1), standard length 1.2 m					
	max. bending radius 13.2 mm	max. bending radius 17.4 mm	max. bending radius 22.5 mm	max. bending radius 13.2 mm	max. bending radius 6 mm	
Mounting	FA (M18x1)					
Temperature range	Storage	Sensor head: -10 ... +80 °C; Fiber optic cable: -60 ... +180 °C			Sensor head: -10 ... +80 °C	Sensor head: -10 ... +80 °C;
	Operation				Fiber optic cable: -40 ... +300 °C	Fiber optic cable: -20 ... +80 °C
Humidity (non-condensing)	20 ... 80 % r.H.			20 ... 60 % r.H.	20 ... 80 % r.H.	
Protection class (DIN EN 60529)	IP64			IP40	IP64	
Sensor head	Stainless steel					
Material	Optical fiber	integrated glass fiber (Ø1.5 mm) and metal-silicone sheathing (T)		integrated glass fiber (Ø3.0 mm) and metal-silicone (T) sheathing	integrated glass fiber (Ø1.0 mm) and metal (M) sheathing	integrated glass fiber (Ø0.6 mm) and PVC plastic (P) sheathing
		Weight	50 g	90 g	114 g	60 g
Compatibility	compatible with all CLS and CFO controllers					
Special features	All variants are also available with different sheath, length 0.3 ... 10 m, vibration protection, IP protection, suitable for drag chains and available for temperature ranges up to 2,000 °C. In combination with a pressure-tight feed-through, a stainless steel sheath and T250° bonding, vacuum applications down to 10 ⁻⁵ mbar are also possible.					

¹⁾ Detection range refers to polished stainless steel.

Accessories

optoCONTROL CLS1000

Art. no.	Model	Description
11245551	PC1000-2-T	Signal / supply cable, 2 m, 5-pin unshielded
11245300	PC1000-5-T	Signal / supply cable, 5 m, 5-pin unshielded
11245301	PC1000-10-T	Signal / supply cable, 10 m, 5-pin unshielded
11245302	PC1000-2	Signal / supply cable, 2 m, 4-pin unshielded
11245303	PC1000-5	Signal / supply cable, 5 m, 4-pin unshielded
11245304	PC1000-10	Signal / supply cable, 10 m, 4-pole unshielded
11245305	PC1000/90-2	Signal / supply cable, 2 m, 4-pole unshielded, 90° outlet
11245306	PC1000/90-5	Signal / supply cable, 5 m, 4-pin unshielded, 90° outlet
2420096	PS2031	Plug-in power supply universal 100 ... 240 V / 24 V / 1 A
2420062	PS2020	PS2020 Power supply unit 24 V
10811916		Pressure-tight feedthrough for vacuum