



SCIGATE AUTOMATION (S) PTE LTD

No.1 Bukit Batok Street 22 #01-01 Singapore 659592

Tel: (65) 6561 0488

Fax: (65) 6562 0588

Email: sales@scigate.com.sg

Web: www.scigate.com.sg

Business Hours: Monday - Friday 8.30am - 6.15pm

More Precision

optoCONTROL // Optical precision micrometers

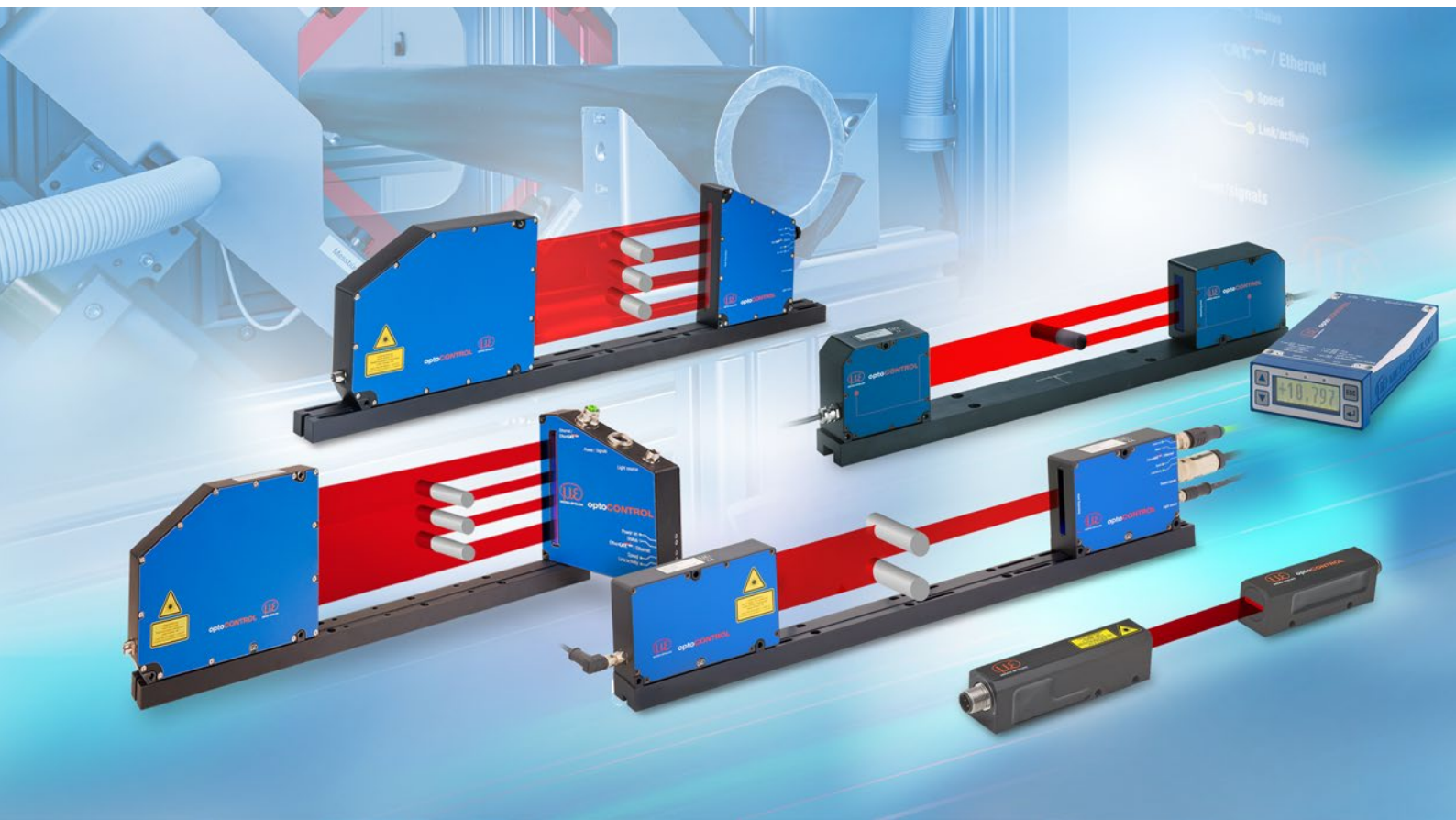

Optical precision micrometer with high resolution optoCONTROL

Small and compact with extremely high measuring rate
for highly dynamic measurement tasks

Highest resolution and accuracy
for highest requirements

Measuring ranges from 2 to 95 mm
for very small and very large measuring objects

Distance-independent measurement
for easy integration

Simultaneous output of several values
for multi-segment measurements

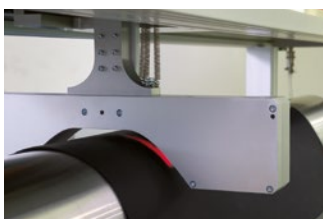
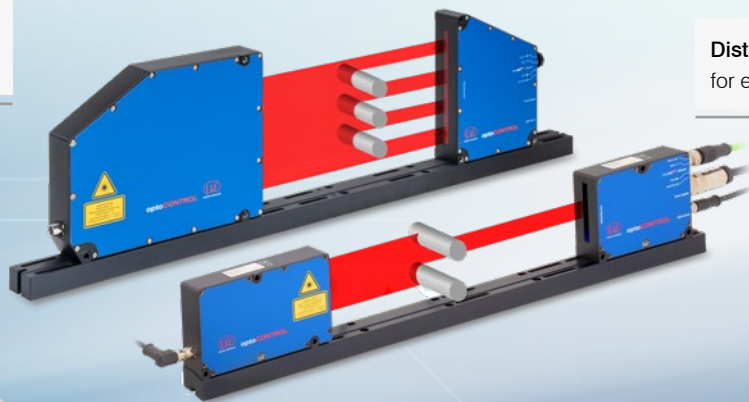
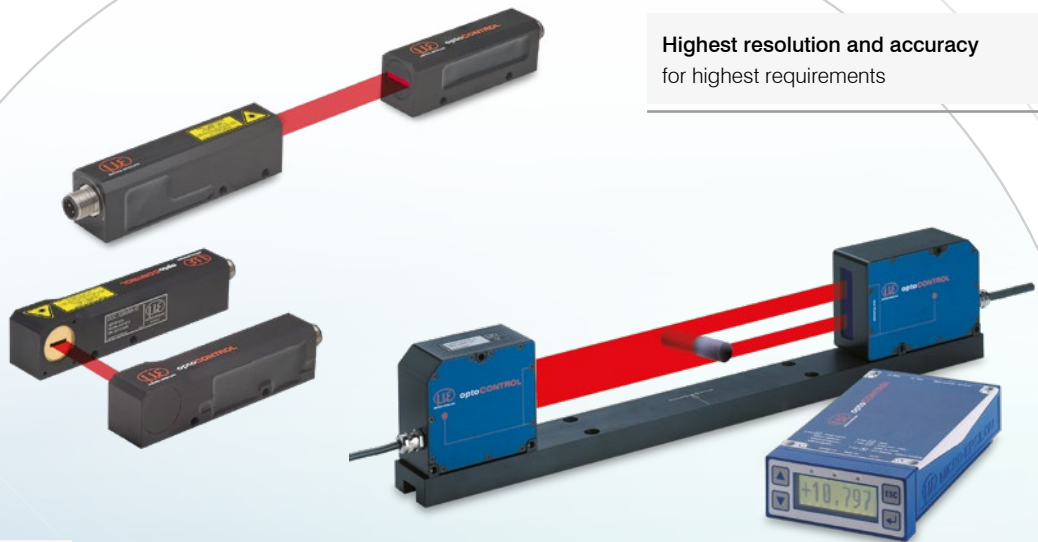

Micrometer for thickness measurement of films and rubber strips

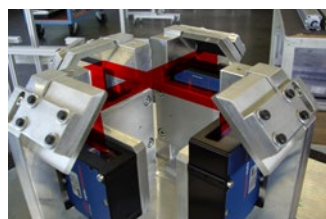

Measuring system detects the X/Y position of a sewing machine needle

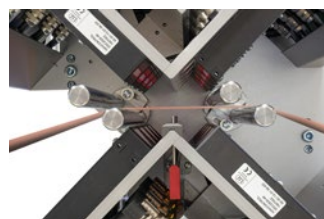

Web edge control of an electrode film

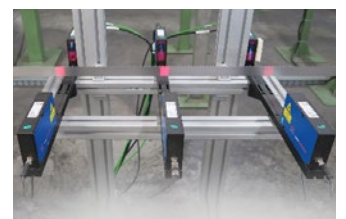



Deflection and straightness measurement of saw blades, steel strips and profiles





General information

Technology	4 - 5
Special features	6 - 7
Application examples	8 - 9

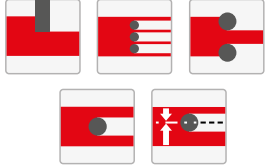

Miniature sensors for high speed applications

	Alignment	Measuring range	Resolution	Linearity	Measuring rate	Measurement modes	Page
optoCONTROL 1200	 Linear	2 – 16 mm	8 μm	2% FSO	100 kHz		10 - 13
optoCONTROL 1200/90	 90°	2 – 16 mm	8 μm	2% FSO	100 kHz		10 - 13
optoCONTROL 1201	 Linear	20 – 30 mm	50 μm	3.5 % FSO	100 kHz		10 - 13

Precise laser micrometers for automation & production monitoring

	Alignment	Measuring range	Resolution	Linearity	Measuring rate	Measurement modes	Page
optoCONTROL 2520-46	 Linear	46 mm	1 μm	$< \pm 12 \mu\text{m}$	2.5 kHz		14 - 17
optoCONTROL 2520-46/90	 90°	46 mm	1 μm	$< \pm 12 \mu\text{m}$	2.5 kHz		14 - 17
optoCONTROL 2520-95	 Linear	95 mm	2 μm	$< \pm 15 \mu\text{m}$	2.0 kHz		18 - 21
optoCONTROL 2520-95/270	 270°	95 mm	2 μm	$< \pm 20 \mu\text{m}$	2.0 kHz		18 - 21

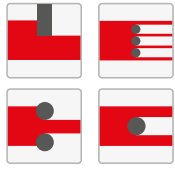
High precision laser micrometers for accurate measurements

	Alignment	Measuring range	Resolution	Linearity	Measuring rate	Measurement modes	Page
optoCONTROL 2600-40	 Linear	40 mm	0.1 μm	$< \pm 3 \mu\text{m}$	2.3 kHz		22 - 25
optoCONTROL 2600-40/209	 Linear	40 mm	0.1 μm	$< \pm 3 \mu\text{m}$	2.3 kHz		22 - 25
optoCONTROL 2600-40/210	 Linear	40 mm	0.1 μm	$< \pm 3 \mu\text{m}$	2.3 kHz		22 - 25

Accessories

Interface modules, cables and accessories	26 - 30
Basics and selection criteria	31

Measuring principle & fields of application

optoCONTROL

Optical precision micrometers

Micrometers from Micro-Epsilon operate according to the transmitted light principle (ThruBeam). Here, the transmitter produces a parallel light curtain that is transmitted via a lens arrangement into the receiver unit. The beam is interrupted if an object is in the light path. The resulting shadowing is detected by the receiving optics and output as geometrical value. These three series use several ThruBeam

technologies to serve the widest possible range of applications. Most optical micrometers are used for two-dimensional measurements in production and quality assurance as well as for service tasks. In this case, variables such as diameter, gap, height, position but also the received light quantity are detected.

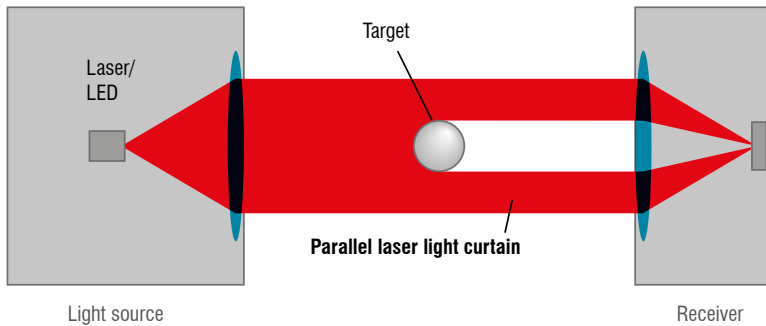

optoCONTROL - wear-free, high speed and accuracy

The real-time light curtain ensures extremely precise measurements, even at high measuring rates. The wear-free design also offers high stability and reliability. Versions with light quantity measurement and imaging e.g. on CCD elements for highest accuracies are selectable.

Quick and easy selection of measurement programs

Due to the predefined measurement programs, the measurement can be selected and performed within a few seconds. From the illustrations, even inexperienced users can easily find the right setting.

The measuring programs eliminate the need for cumbersome parameterization and allow simple settings to be made so that measurements can be started quickly.

Schema	Operating mode	Description
	Edge light/dark	Position of the first light/dark edge (distance from the start of line)
	Edge dark/light	Position of the first dark/light edge (distance from the start of line)
	Diameter/width	Measure, position and center axis of an outer diameter or width of a metal sheet (first light/dark and last dark/light edge)

Schema	Operating mode	Description
	Gap	Measure, position and center axis of a gap (first dark-light edge and the following edge)
	Segments	Differences, positions and center axes of up to 8 arbitrary segments
	Diameter	Center axis of an outer diameter

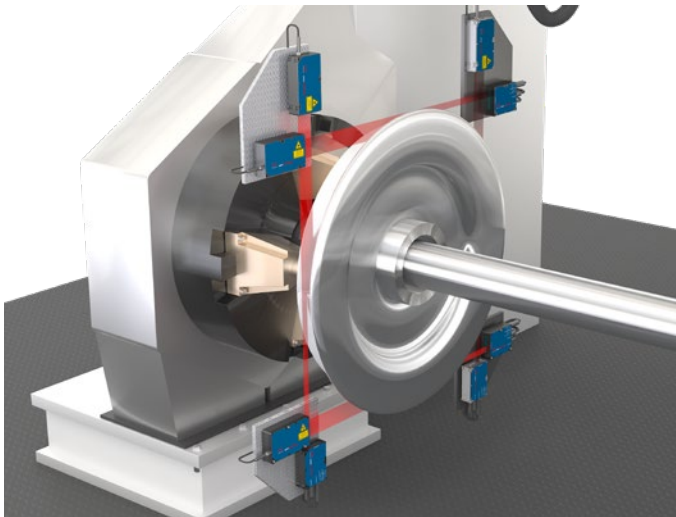

Measurement of a railroad wheel

Special fields of application

For special fields of application and larger purchase quantities, all optoCONTROL ODC sensor model series can be customized.

This includes for example:

- Individual cable lengths with modified cable outlet
- Version with reduced or extended distance between light source and receiver
- Version with deflecting mirror for confined installation spaces

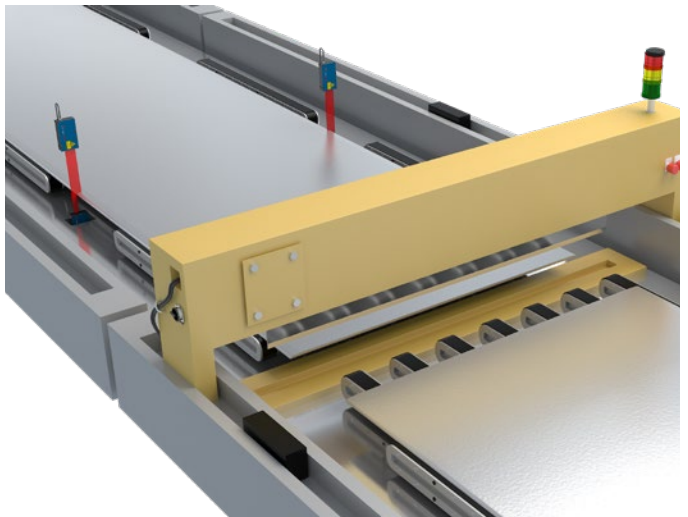

Web edge control of metal sheets with external synchronous evaluation

Wear-free and long service life

All optoCONTROL models work without rotating mirrors and are therefore almost wear-free. The parallel light curtain is created by special optics in the light source. High quality components in the receiving optics, e.g. filters and lenses, enable the high accuracy. This is why optoCONTROL micrometers are particularly suitable for areas where high precision and reliability are required.

Object-independent measurement through shadowing principle

The great advantage of optical micrometers from Micro-Epsilon is the object-independent measurement. Due to the shadowing principle, surface properties such as specularity or reflectance of the measuring object have hardly any influence on the receiver unit. Semi-transparent objects can be measured reliably. The optoCONTROL 2600 also detects transparent objects easily.

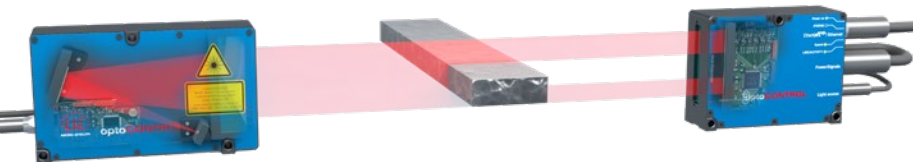

Selection criteria optoCONTROL

Numerous measuring ranges for versatile measurement tasks

Optical precision micrometers of the optoCONTROL series are available with different measuring ranges and are ideally suited for industrial applications. More than 10 standard models with measuring ranges from 2 – 95 mm cater for a large number of applications across many different industries.

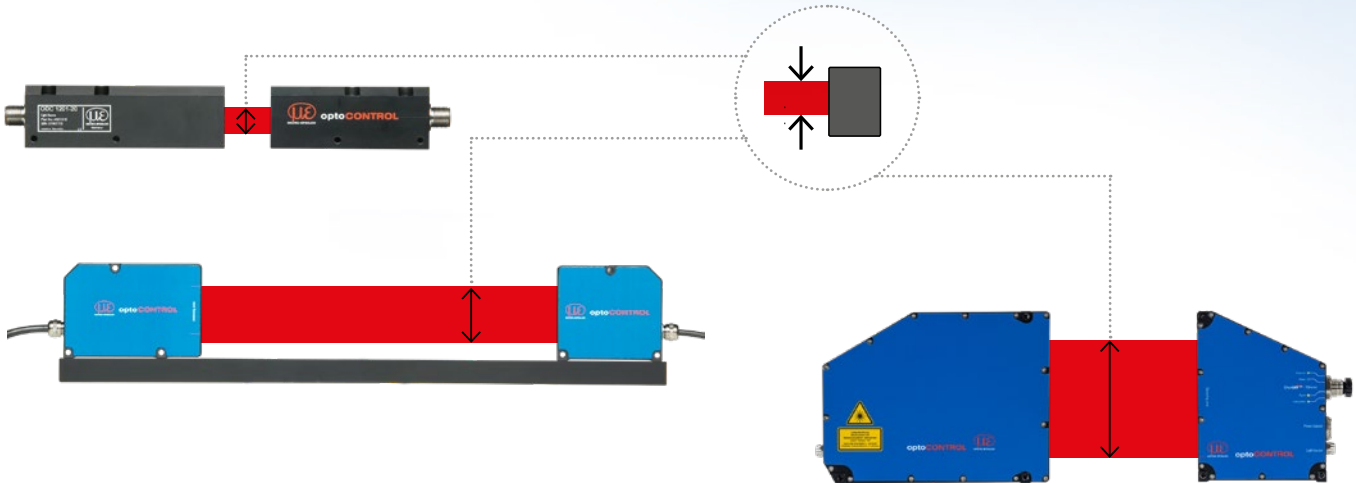

Unique operating concept for quick and easy commissioning

The optoCONTROL 2520 micrometers are operated using an intuitive web interface, which can be accessed via a standard web browser. This enables readings and limit values to be displayed as well as the selection and application of filters. Furthermore, a video signal is available to precisely configure the measurement.

Parameter setting of the respective measuring programs is quick and intuitive. For each segment, gap or diameter, the center axis and the position of the individual edges can be output.

sensorTOOL

The Micro-Epsilon sensorTOOL is a powerful software that is used to operate one or more optoCONTROL sensors. The sensorTOOL can be used to access the sensor connected to the PC, display its complete data stream and save it in a file (in Excel-compatible CSV format).

Free download

All software tools, drivers and documented driver DLL for easy integration of the sensors into existing or internally-generated software are available free of charge under www.micro-epsilon.de/download

Angle variants

The 90° variant enable the installation even in confined spaces. For integration in machines where the available space is very limited, the angled micrometer variants are ideal.

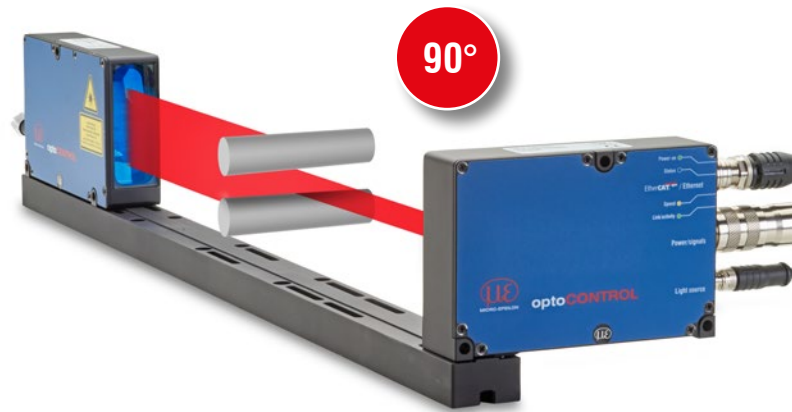

Modern interfaces for integration into machines and systems

Numerous interface and signal processing units extend the field of application of the Micro-Epsilon micrometers.

The interface modules are used to convert the sensor signals into digital or bus-compatible interfaces. This enables interfaces such as USB, RS422, Ethernet/IP, Profinet and EtherCAT.

Synchronizable sensors for large diameter measurement, multi-track applications and X-arrangements

Operating several ODC sensors to measure in a track or the thickness of large diameters requires synchronization. Synchronizing the sensors enables simultaneous measurement acquisition and ensures that the measurement values of the sensors are recorded at the same time.

Due to their synchronization feature, optoCONTROL ODC sensors are suited to multi-track and thickness measurements of large diameters.

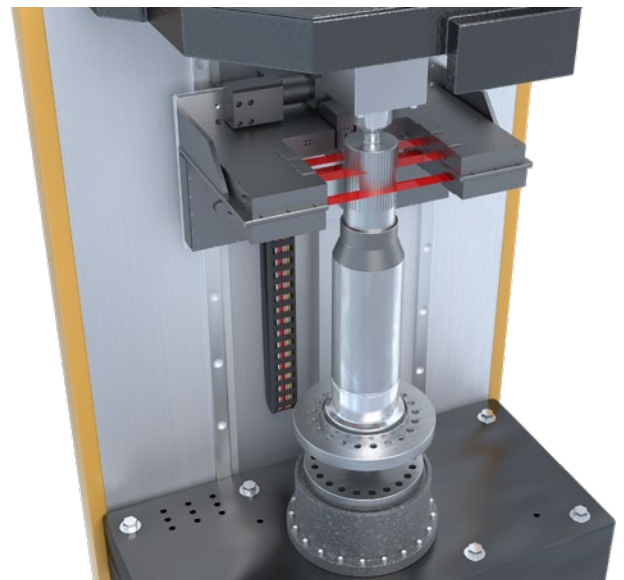

Certified quality with calibration protocol

To document the performance capability of the optoCONTROL 2520 and 2600 series, each sensor is calibrated before delivery and supplied with its own calibration protocol. This document is included in delivery.

Applications

optoCONTROL

Parameter monitoring of continuous loop strap for cable ties

It is essential that the "width" and "height" of the cable ties are monitored concurrently and constantly during the production of these endless cable ties. These values are crucial to ensure a consistently good and reliable binding result. Monitoring of specific product parameters during the entire process is pivotal in ensuring the quality and uniformity of production. For this purpose, a sensor combination of two optical precision micrometers mounted behind the extruder is used. Two ODC 2520-46 type sensors are positioned both horizontally and vertically and measure the height and width of the strap.

Recommended sensor: ODC2520-46

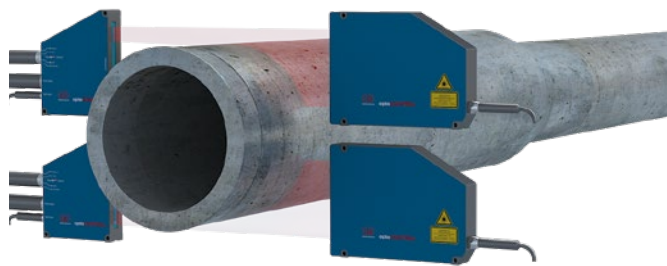
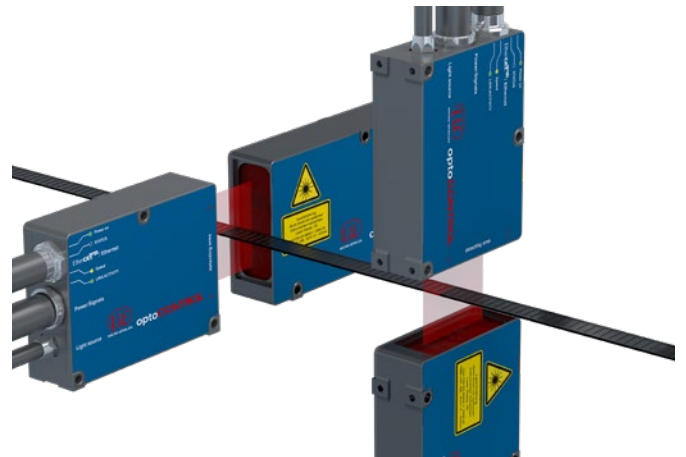

Diameter inspection of large pipes

Large pipe diameters can be measured using two ODC2520-95 sensors. For this purpose, the signal of the two sensors and their distance to each other is calculated. This means that even very large diameters that are beyond the measuring range of a single sensor can be detected easily.

Recommended sensor: ODC2520-95

Detection of the glass runout

After the production of drinking glasses, a cutting machine cuts off the lid, which is formed during glass blowing. Subsequently, each glass is measured under a 360° rotation and the glass runout is calculated using the measured value. The optoCONTROL OCD2520-95 measures with an accuracy of $<20 \mu\text{m}$.

Recommended sensor: ODC2520-95

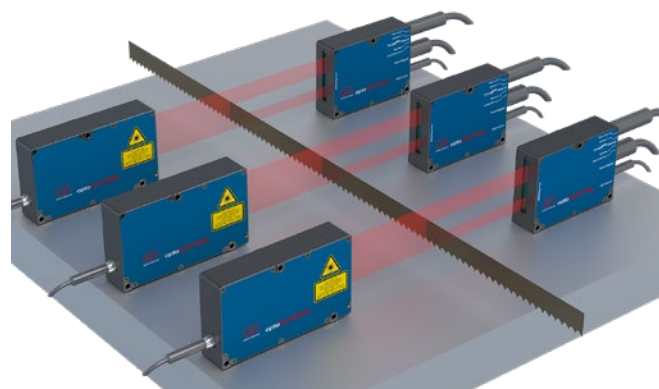
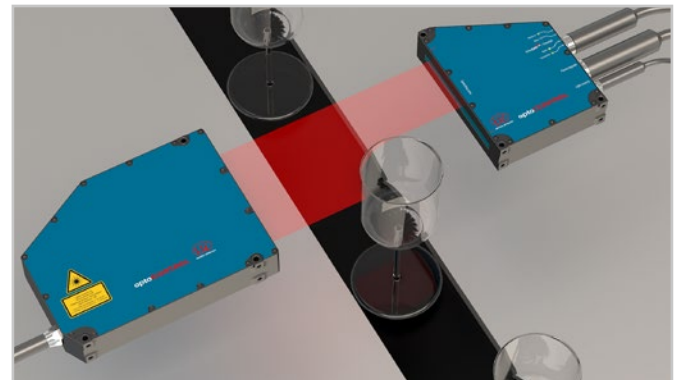

Deflection and straightness measurement of saw blades and steel strips

In the production and processing of metal strips, numerous measurement parameters need to be monitored, e.g., straightness, deflection and saw edge. This allows deviations and production errors to be detected early on. Three optical ODC2520-46 micrometers from Micro-Epsilon are used for reliable production monitoring. This complete solution for deflection measurement offers flexible integration due to freely selectable sensor distances.

Recommended sensor: ODC2520-46

Edge detection and runout measurement

During the production of wafers, the edges and the concentricity of the manufactured wafers are continuously checked in the machine. In an area that is protected from radiant heat outside the vacuum, the ODC2520-46(090) measures the edge of the wafer to calculate the runout while the wafer rotates once around its axis. Depending on the size of the measuring range of the micrometer, wafers of different sizes can be measured without having to adjust the position of the sensor. With the 46 mm measuring range, for example, 3 to 4.8 inch wafers can be detected.

Recommended sensor: ODC2520-46(090)

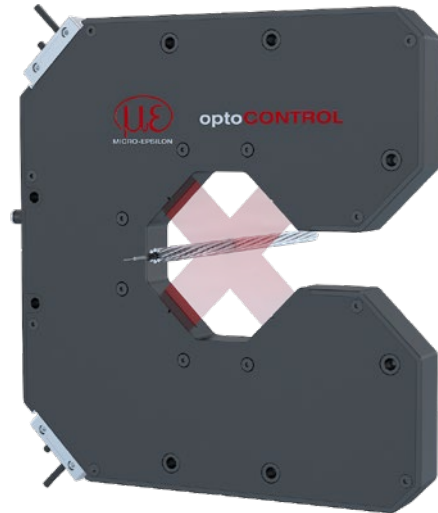
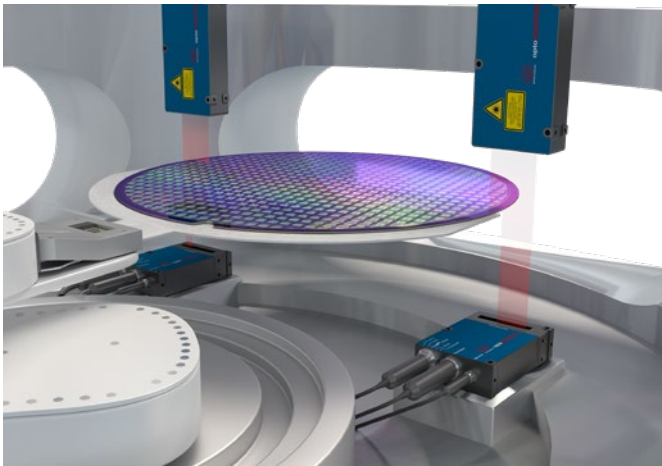

Diameter inspection of steel and wire rod products

After stranding several wires, the diameter must be continuously checked in quality assurance. For the measurement of steel or wire rod products, a 2-axis frame is used for the X-arrangement of two optoCONTROL sensors. The integrated air purge unit allows continuous cleaning of the optics by compressed air.

Recommended sensor: XFrame with ODC2520

Quality control of press tools for tablet production

Press tools for the tablet production are subject to a continuous wear control. Due to complex geometries and strongly reflecting surfaces, optical inspections are only possible with high precision measuring techniques. An optical micrometer enables to inspect the tools in a special measuring system. The press tools are tested for different parameters. With a resolution of $0.1 \mu\text{m}$ and linearity of $\pm 3 \mu\text{m}$, the ODC2600 measures the diameters of individual punches with very high precision.

Recommended sensor: ODC2600-40

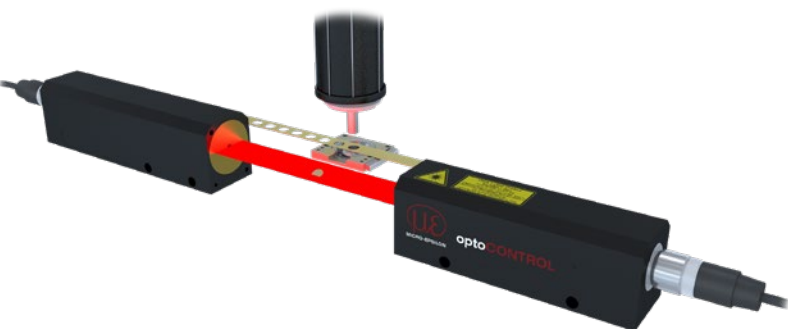





Punching holes in a plate of gold

Small holes of approx. 0.1 mm are punched continuously in gold and silver tapes. After the punching process, the punched plates drop out. Due to their high measuring rate, the ODC1200-2 sensors are ideally suited for detection, as they can detect the platelet dropping out after the punching process extremely quickly, even in the smallest dimensions.

Recommended sensor: ODC1200-2

Compact laser micrometers with high measuring rate

optoCONTROL 1200/1201

-  Measuring ranges 2 - 30 mm
-  Resolution $\geq 8 \mu\text{m}$
-  Measuring rate up to 100 kHz (-3 dB)
- INTERFACE** Analog output 0 up to 10 VDC
-  Laser class 1
-  Detection of smallest objects from $\geq 0.03 \text{ mm}$

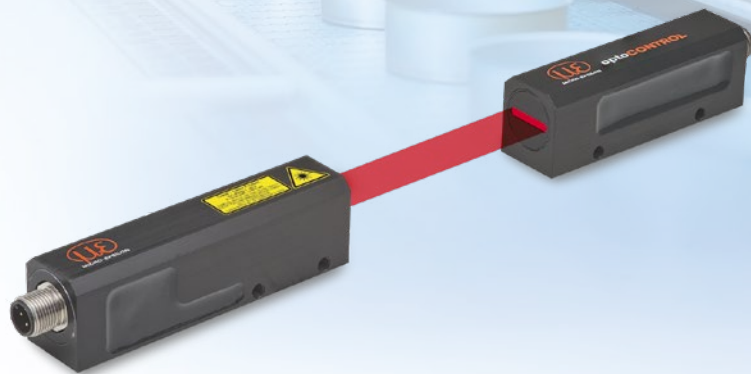

Light source and receiver can be mounted at any distance up to 5 m from each other. All models can be mounted both vertically and horizontally without additional brackets. The compact design of the housings and the 90° design allow the miniature micrometers to be mounted even in confined installation spaces. In addition the analog output, an adjustable limit switch is included. This can be operated in NPN (light switching) as well as in PNP logic (dark switching).

The optoCONTROL 1200 can reliably measure the smallest diameters from 0.3 mm. For gap measurements from 50 μm , an option with energetic light quantity measurement is offered.

Measurement mode

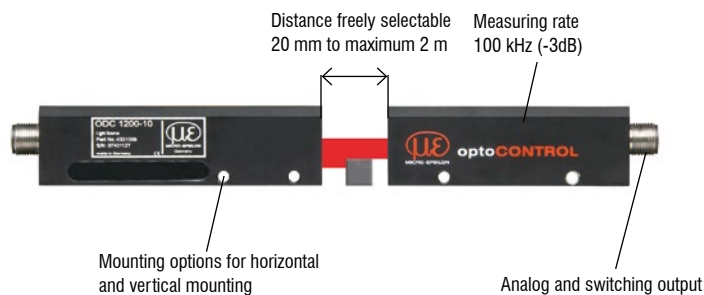
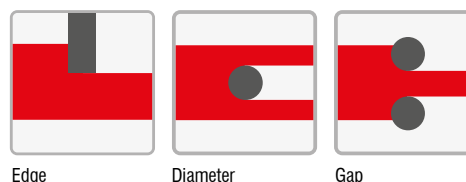

optoCONTROL 1200/90:
Version with 90° beam path for mounting in narrow installation spaces.
Optional mounting with ODC1202-L mounting rail as C-frame.

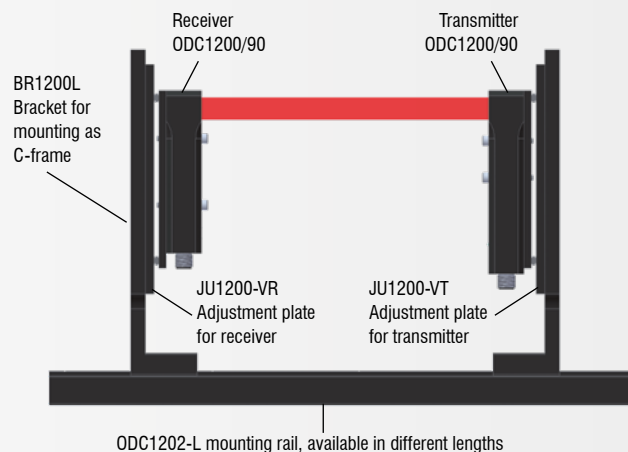

Model		ODC 1200 (axial model)				ODC 1200/90 (90 model)				ODC1201	
Measuring range		2 mm	5 mm	10 mm	16 mm	2 mm ³⁾	5 mm	10 mm	16 mm	20 mm	30 mm
Min. target size ²⁾		≥ 0.03 mm	≥ 0.05 mm	≥ 0.1 mm	≥ 0.15 mm	≥ 0.03 mm	≥ 0.05 mm	≥ 0.1 mm	≥ 0.15 mm	≥ 0.15 mm	≥ 0.2 mm
Distance light source - receiver (free space) ¹⁾		min. 30 mm to 150 mm ¹⁾ max. 2.5 m									
Measuring distance (measured object - receiver)		20 mm ... 2000 mm; Optimum distances: 20, 50 mm ¹⁾									
Measuring rate		100 kHz (-3 db)									
Resolution		8 μm	10 μm	20 μm	30 μm	8 μm	10 μm	20 μm	30 μm	50 μm	70 μm
Linearity ²⁾		±2 % FSO		±3.5 % FSO		±2 % FSO		±3.5 % FSO			
Repeatability ⁴⁾⁵⁾		≤16 μm	≤20 μm	≤40 μm	≤60 μm	≤16 μm	≤20 μm	≤40 μm	≤60 μm	≤100 μm	≤140 μm
Light source		Semiconductor laser 670 nm (red)									
Laser class		Laser class 1 (Pmax ≤ 0.39 mW) according to IEC 60825-1:2014									
Permissible ambient light		≤ 5000 lx ⁶⁾									
Analog output		0 ... 10 VDC (adjustable amplification, depending on direction)									
Digital interface		Ethernet ⁷⁾ , EtherCAT ⁷⁾ (max. 14 Bit/4 kSa/s)									
Switching output		PNP dark switching and NPN light switching (max. switching frequency 60 kHz) adjustable switching threshold									
Signal input		Laser control (light source) 0 ... 5 VDC									
Connection	Receiver	4-pin M12 socket for power supply, analog and digital output									
	Light source	4-pin socket M12 for supply and laser control									
Mounting		Mounting rail, adjustment plates (see accessories), mounting holes									
Temperature range	Storage	-20 ... + 70 °C									
	Operation	0 ... + 50 °C									
Supply voltage		12 ... 32 VDC									
Maximum power consumption		< 0.3 A									
Shock (DIN EN 60068-2-27)		15 g / 6 ms									
Vibration (DIN EN 60068-2-6)		15 g / 0.01 ... 1 kHz									
Protection class (DIN EN 60529)	Receiver / light source	IP67									
Material	Receiver / light source	Aluminum housing									
Weight	Light source	approx. 150 g				approx. 170 g				approx. 260 g	
	Receiver	approx. 120 g				approx. 160 g				approx. 220 g	
Measuring programs		Edge (outer-) diameter / width gap									
Control and indicator elements		Receiver (LED) indication: switching state indicator and dirt with free beam path Light source (LED) indication: power ON/OFF									
Special features		Measurements server for transmission of several measurements to the PC (optional IF1032/ETH)									

FSO = Full Scale Output

The specified data apply for a constant room temperature of 20 °C after a warm-up period of 180 min, in the range 10 ... 90 % of the analog output at a distance of 150 mm between light source and receiver without ambient light effect.

Analog offset if laser beam is covered without ambient light < 0.05 V

¹⁾ Linearity and resolution decrease with larger distances.

²⁾ Applies in the mid of the measuring range for distance: target - receiver 20 mm; distance: light source - receiver 150 mm.

³⁾ For gap measurement 50 ... 400 μm, an option is available with a regulated controller for transmitted light operation and measurement distance up to 700 mm.

⁴⁾ The specified values apply at ±2 sigma

⁵⁾ Measured in the mid of the measuring range with static noise over 3 min.

⁶⁾ With direct or indirect irradiation, shadowing from daylight increases the stability of the measurement

⁷⁾ Connection via interface module (see accessories)

Compact laser micrometers with high measuring rate optoCONTROL 1200/1201

optoCONTROL 1200

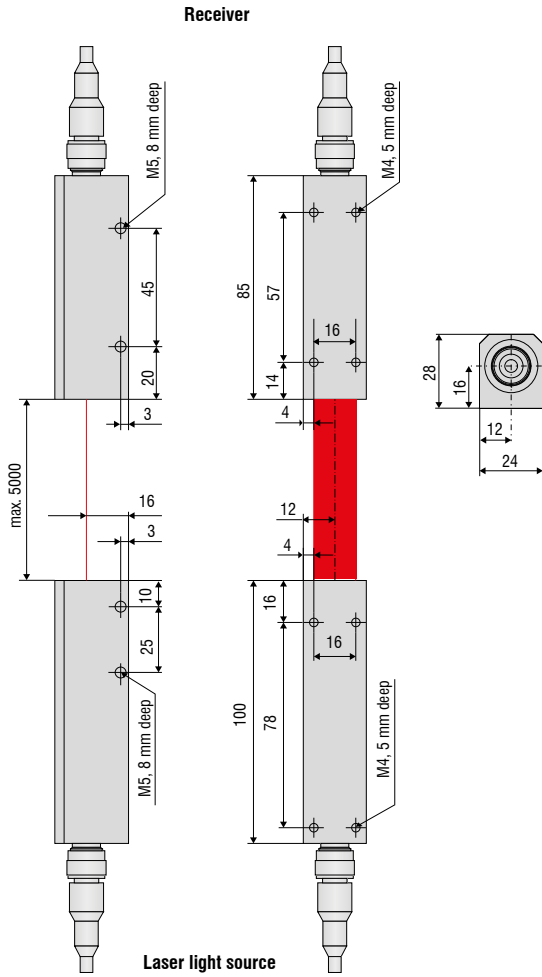

optoCONTROL 1201

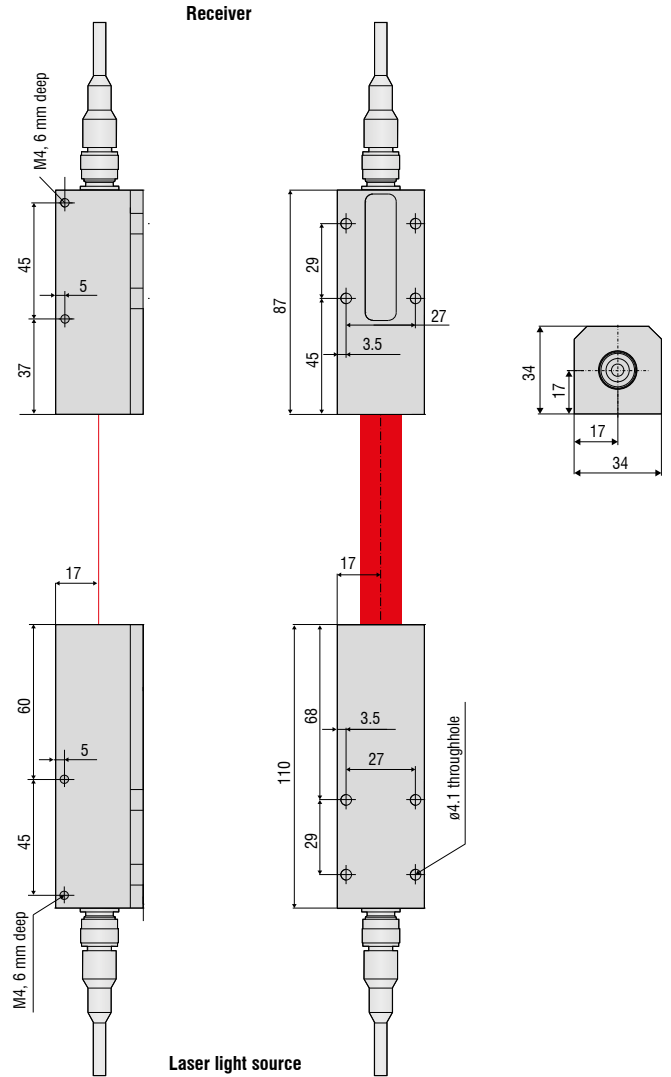



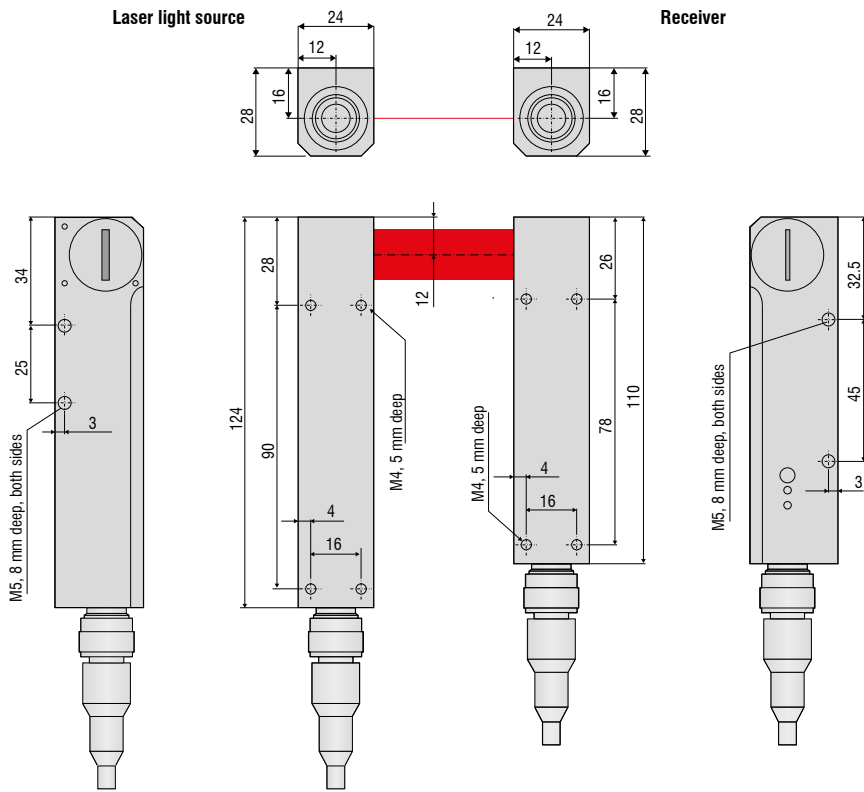

optoCONTROL 1200/90



Precise laser micrometer with integrated controller

optoCONTROL 2520-46

-  Measuring range 46 mm
-  Measurement distances up to 2 m
-  Linearity $\pm 12 \mu\text{m}$
- INTERFACE** Ethernet / EtherCAT / RS422 / Analog / EtherNet/IP / PROFINET
-  Laser class 1M
-  Configurable via web interface

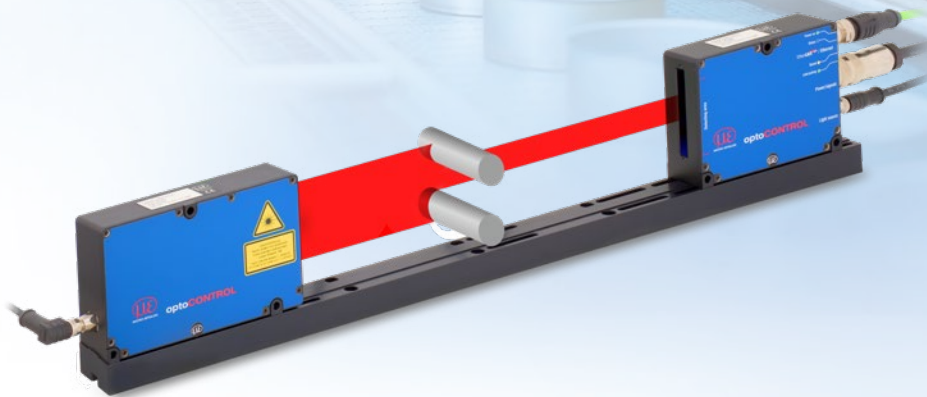

optoCONTROL 2520-46 is a compact laser micrometer which is characterized by high accuracy with a large measuring range of 46 mm. The optoCONTROL 2520 is flexible; the measuring object can be placed at any position within the light curtain and the distance from the light source to the receiver can be freely selected. The smallest detectable target diameter is 0.5 mm, which allows for example PINs and small gaps to be detected. The optoCONTROL 2520 is also used for counting tasks and roundness measurements.

Measurement modes

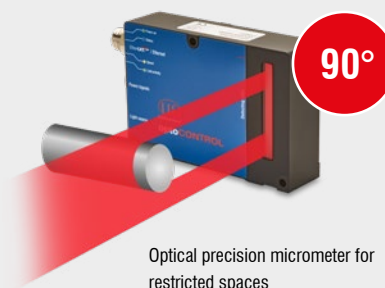
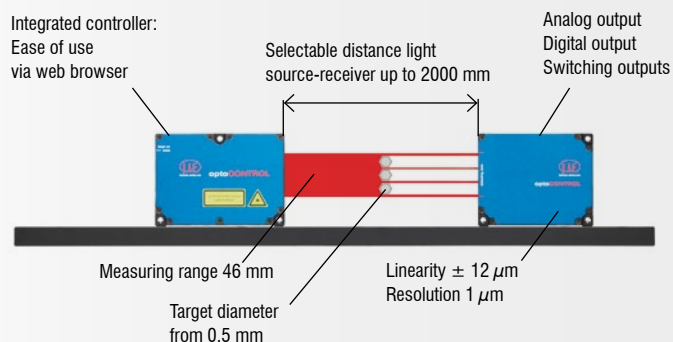
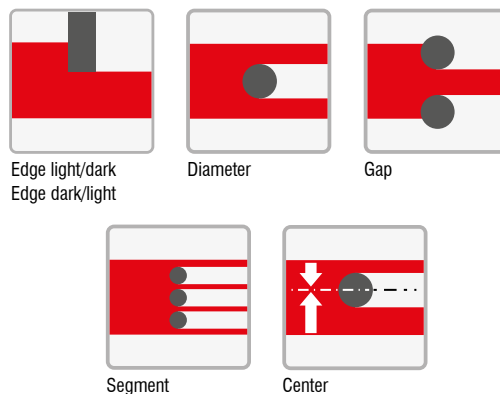

Model	ODC 2520-46	ODC 2520-46(090) angled at 90°
Measuring range	46 mm	
Min. target size	typ. ≥ 0.5 mm	
Distance light source - receiver (free space)	with mounting rail 100 ... 300 mm; without mounting rail open to approx. 2000 m	
Measuring distance (target - receiver)	20 mm ... 2000 mm; optimum distances: 20, 50, 100, 150 mm	
Measuring rate	2.5 kHz	
Resolution ¹⁾	1 μ m	
Linearity ²⁾	$< \pm 12 \mu$ m	
Repeatability ³⁾	$\leq 5 \mu$ m	
Light source	Semiconductor laser 670 nm (red)	
Laser class	Laser class 1M (P_{max} 2 mW) according to DIN EN 60825-1 : 2015-07	
Permissible ambient light	approx. 20,000 lx	
Analog output	0 ... 10 V not electrically separated, 14-bit D/A	
Digital interface	RS422 (max. 4 MBaud), full duplex, not electrically separated / Ethernet, electrically separated / EtherCAT / EtherNet/IP ⁴⁾ / PROFINET ⁴⁾	
Switching output	2 outputs, optionally for errors or limits, not electrically separated / 24 V logic (HTL), High level depends on supply voltage	
Signal input	Zero setting/mastering, resetting to factory defaults; not electrically separated, 24 V logic (HTL) High level depends on supply voltage; TriglN / SynclN via RS422 level	
Digital output	SyncOut symmetric, RS422 level, terminating resistance (120 ohm) direction can be switched via software, not electrically separated	
Connection	Receiver	3-pin socket M8 for supply of light source; 14-pin M16 socket for power supply & signals, 4-pin M12x1 socket for Ethernet / EtherCAT
	Light source	3-pin socket M8 for supply
Mounting	Mounting rail (see accessories), mounting holes	
Temperature range	Storage	-20 ... +70 °C
	Operation	0 ... +50 °C
Supply voltage	+24 VDC (11 ... 30 VDC)	
Maximum power consumption	< 1 A	
Shock (DIN EN 60068-2-27)	15 g / 6 ms	
Vibration (DIN EN 60068-2-6)	2 g / 20 ... 500 Hz	
Protection class (DIN EN 60529)	Receiver / light source	IP64
Material	Receiver / light source	Aluminum housing
Weight	1.25 kg (without cable)	
Measuring programs	Edge light-dark; edge dark-light (outside) diameter / width incl. edges & center axis gap / (inside diameter) incl. edges & center axis any segments, incl. segment edges & center axes	
Control and indicator elements	Web interface for setting parameters and display; color LEDs for Power on, Status, Speed, Link/activity	
Special features	Integrated web server for transmission of several measurements to the PC; optional other periphery devices, see operating instructions	

The specified data apply for a consistent room temperature of 20 °C, continuously in operation, signal outputs open and sensor mounted on included mounting rail
Measured at light source - receiver distance of 300 mm, measured object - receiver distance of 20 mm, operating mode: edge light-dark

¹⁾ At the digital interface

²⁾ Measured with 3 sigma

³⁾ Measured with a moving average over 32 values

⁴⁾ Connection via interface module (see accessories)

Precise laser micrometer with integrated controller

optoCONTROL 2520-46

optoCONTROL 2520-46

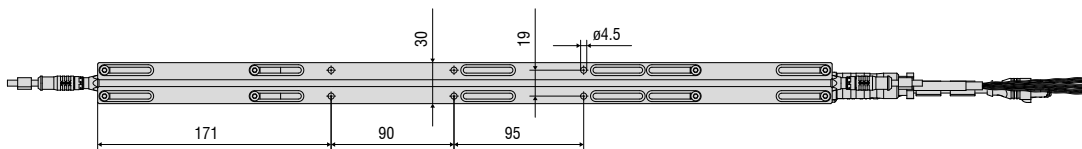
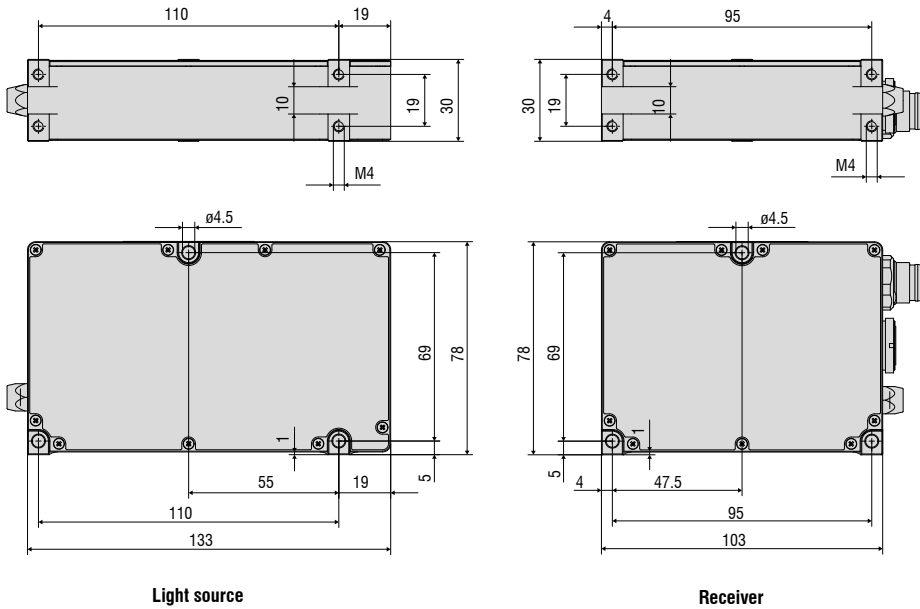

Light source and receiver with mounting rail

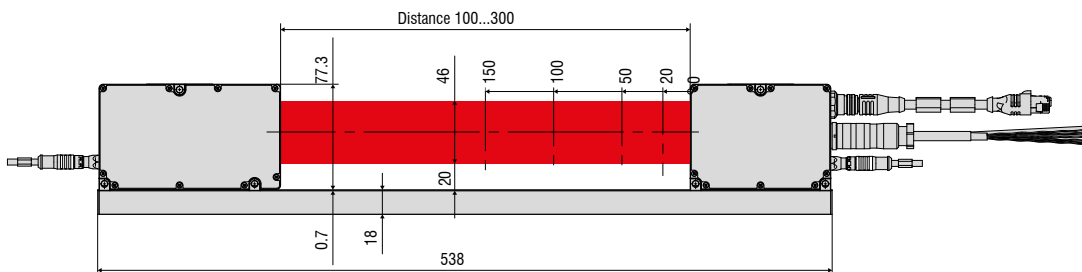

optoCONTROL 2520-46(090), 90° angle

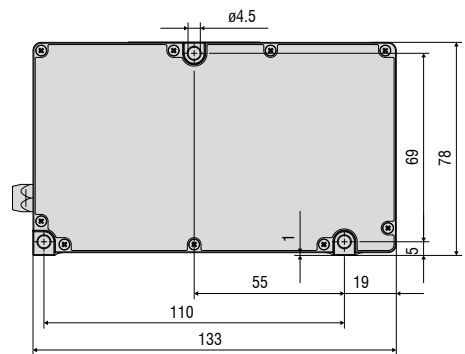
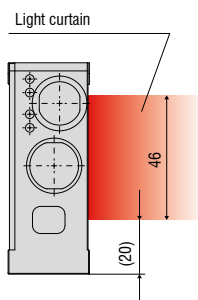
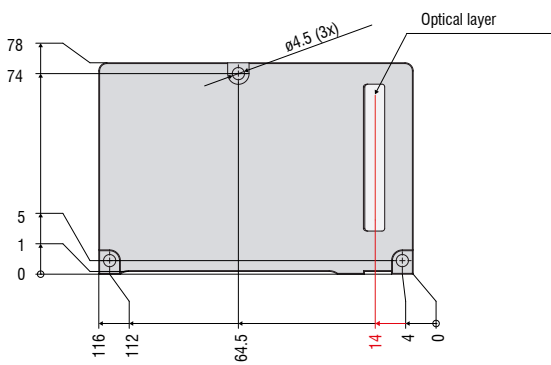
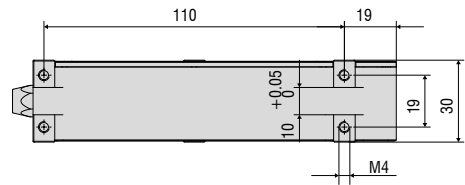
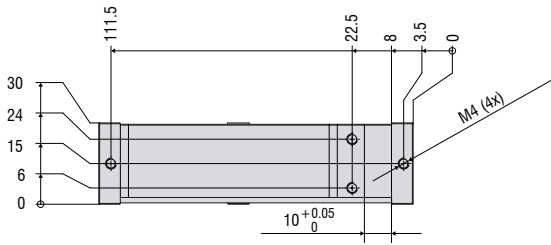

Light source

Receiver

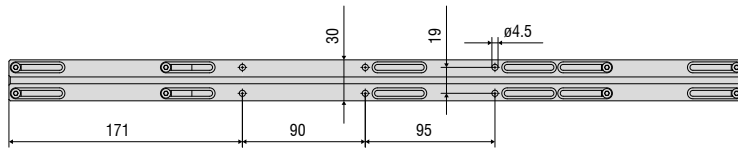



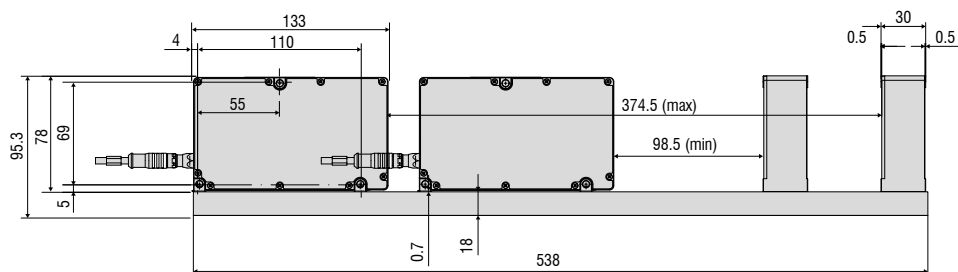

Light source and receiver with mounting rail



Precise laser micrometer with large measuring range

optoCONTROL 2520-95

-  Measuring range 95 mm
-  Measurement distances up to 2 m
-  Linearity $\pm 15 \mu\text{m}$
- INTER FACE** Ethernet / EtherCAT / RS422 / Analog / EtherNet/IP / PROFINET
-  Laser class 1M
-  Configurable via web interface

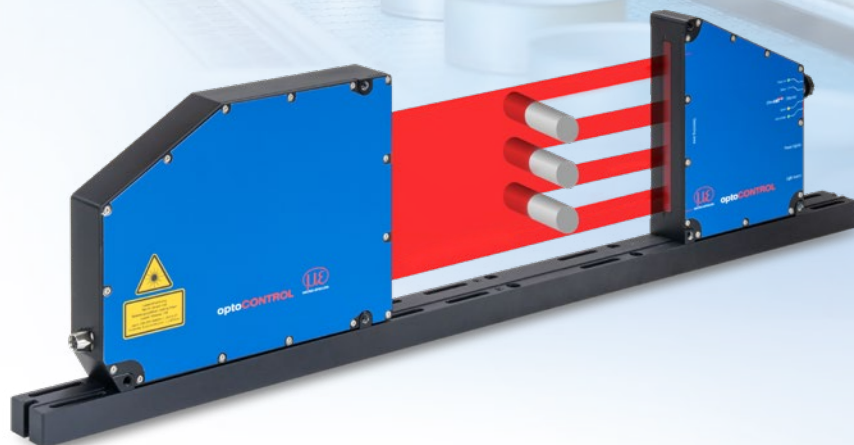

The optoCONTROL 2520-95 is a compact laser micrometer that features excellent linearity and high accuracy with a large measuring range of 95 mm. The optoCONTROL 2520-95 is flexible; the measuring object can be placed at any position within the light curtain and the distance from the light source to the receiver can be freely selected.

The precise measurement results can be output at a measuring rate up to 2000 values per second. Moreover, the powerful micrometer also enables the simultaneous measurement of up to 8 segments and the synchronous output of several measurement values.

Depending on the installation scenario and the available installation space, the angled variant (270°) can reduce the required space.

Measurement modes

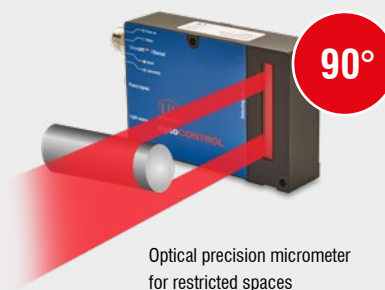
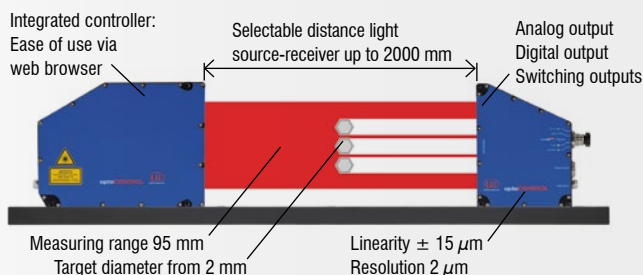
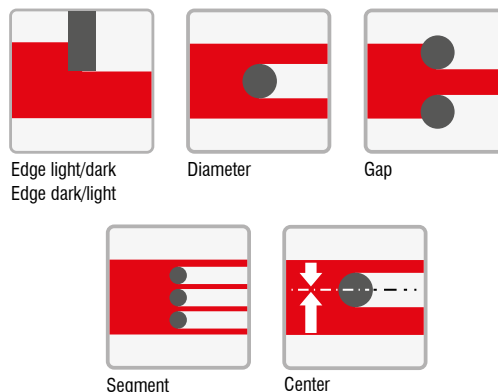

Model	ODC 2520-95	ODC 2520-95(270) angled at 90°
Measuring range	95 mm	
Min. target size	typ. $\geq 2.0 \text{ mm} / 100 \mu\text{m}$ ⁴⁾	
Distance light source - receiver (free space)	with mounting rail 100 ... 300 mm; without mounting rail open to approx. 2000 m	
Measuring distance (target - receiver)	20 mm ... 2000 mm; optimum distances: 20, 50, 100, 150 mm	
Measuring rate	2.0 kHz	
Resolution ¹⁾	2 μm	
Linearity ²⁾	< $\pm 15 \mu\text{m}$	< $\pm 20 \mu\text{m}$
Repeatability ³⁾	$\leq 6 \mu\text{m}$	
Light source	Semiconductor laser 670 nm (red)	
Laser class	Laser class 1M (P _{max} 2 mW) according to DIN EN 60825-1 : 2015-07	
Permissible ambient light	approx. 15,000 lx	
Analog output	0 ... 10 V not electrically separated, 14-bit D/A	
Digital interface	RS422 (max. 4 MBaud), full duplex, not electrically separated Ethernet, electrically separated / EtherCAT / EtherNet/IP ⁵⁾ / PROFINET ⁵⁾	
Switching output	2 outputs, optionally for errors or limits, not electrically separated / 24 V logic (HTL), High level depends on supply voltage.	
Signal input	Zero setting/mastering, resetting to factory defaults; not electrically separated, 24 V logic (HTL) High level depends on supply voltage; TriglN / SynclN via RS422 level	
Digital output	SyncOut symmetrical, RS422 level, terminating resistor (120 ohm) direction can be switched using software, not electrically separated	
Connection	Receiver	3-pin socket M8 for supply of light source; 14-pin M16 socket for power supply & signals, 4-pin M12x1 socket for Ethernet / EtherCAT
	Light source	3-pin socket M8 for supply
Mounting	Mounting rail (see accessories), mounting holes	
Temperature range	Storage	-20 ... +70 °C
	Operation	0 ... +50 °C
Supply voltage	+24 VDC (11 ... 30 VDC)	
Maximum power consumption	< 1A	
Shock (DIN EN 60068-2-27)	6 g / 6 ms in 3 axes, 1000 shocks each	
Vibration (DIN EN 60068-2-6)	2 g / 10 ... 500 Hz in 3 axes, 10 cycles each	
Protection class (DIN EN 60529)	Receiver / light source	IP64
Material	Receiver / light source	Aluminum housing
Weight	2.0 kg (without cable)	
Measuring programs	Edge light-dark; edge dark-light; (outside) diameter / width incl. edges & center axis gap / (inside diameter) incl. edges & center axis; any segments, incl. segment edges & center axes	
Control and indicator elements	Web interface for setting parameters and display; color LEDs for Power on, Status, Speed, Link/activity	
Special features	Integrated web server for transmission of several measurements to the PC; optional other periphery devices, see operating instructions	

The specified data apply for a consistent room temperature of 20 °C, continuously in operation, signal outputs open and sensor mounted on included mounting rail.

Measured at light source - receiver distance of 300 mm, measured object - receiver distance of 20 mm, operating mode: edge light-dark

¹⁾ At the digital interface

²⁾ Measured with 3 sigma

³⁾ Measured with a moving average over 32 values

⁴⁾ Smallest detectable object, not measurable

⁵⁾ Connection via interface module (see accessories)

Precise laser micrometer with large measuring range

optoCONTROL 2520-95

optoCONTROL 2520-95

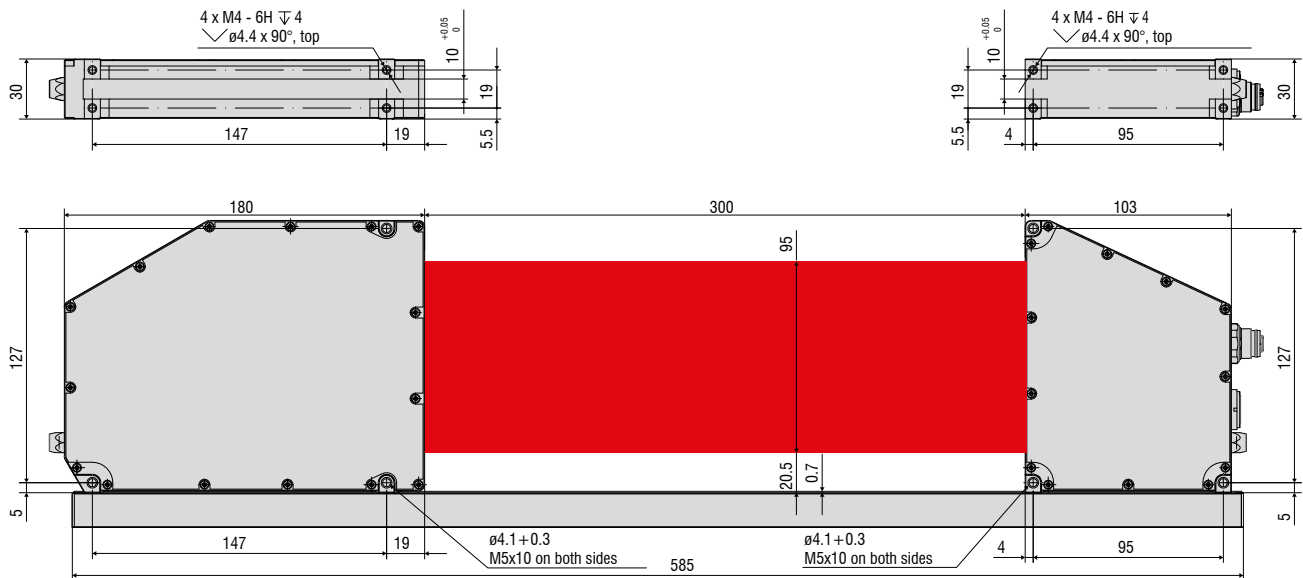

Light source

Receiver

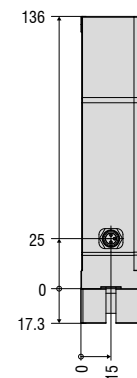
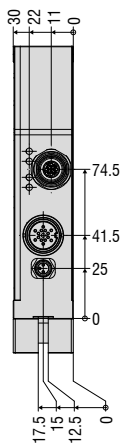
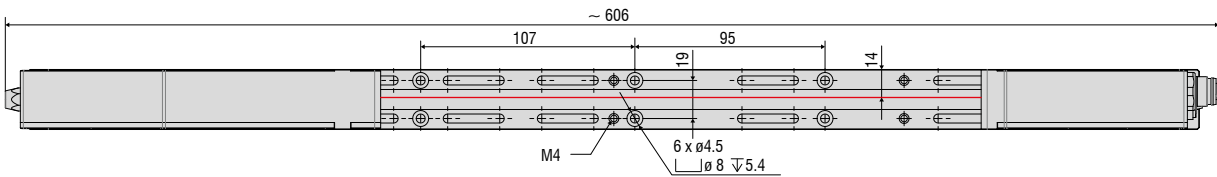

optoCONTROL 2520-95(270), 90° angle

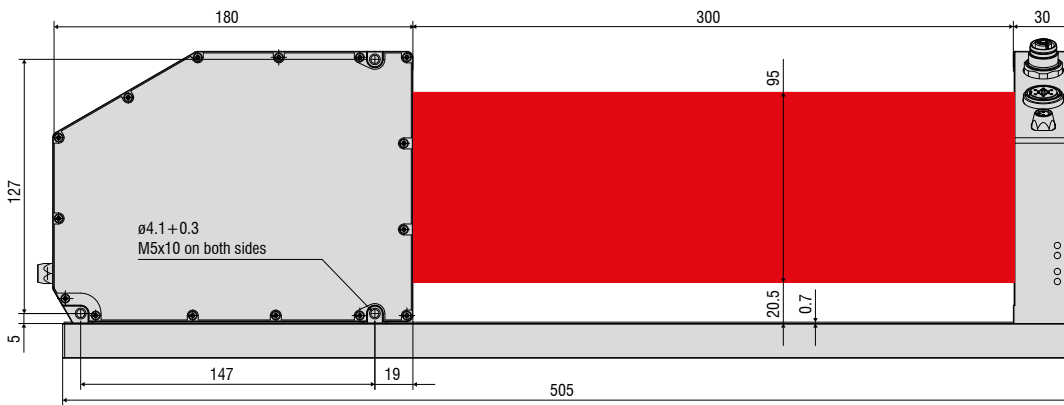





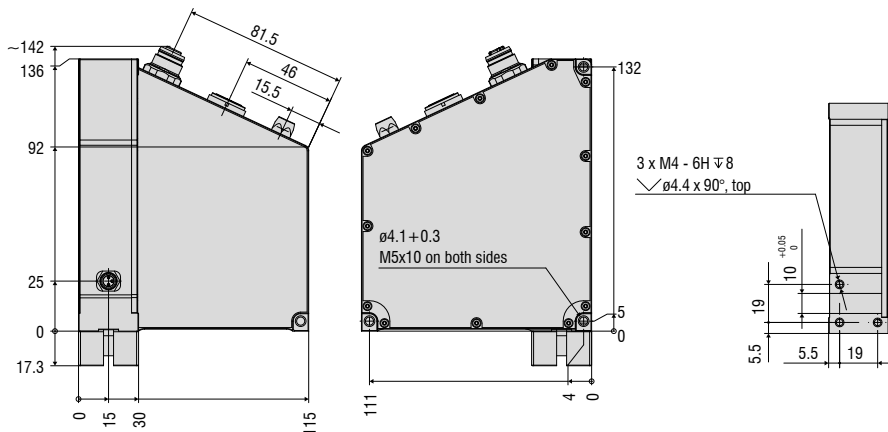
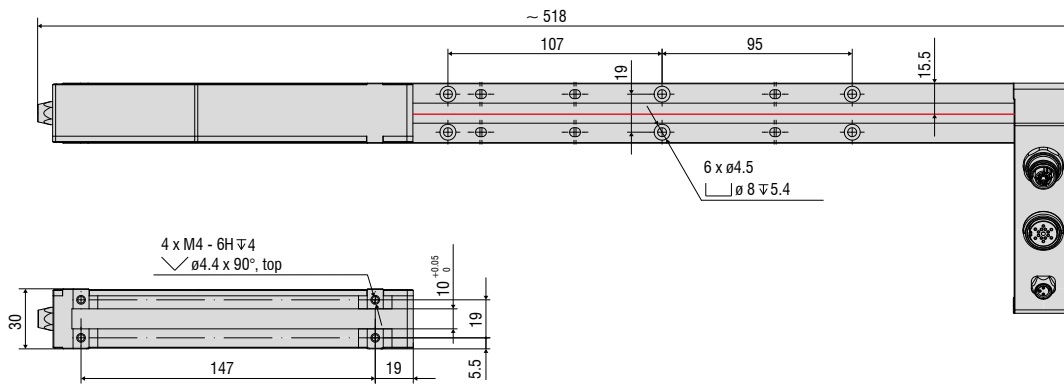

Light source

Receiver



High-resolution LED micrometer optoCONTROL 2600

-  Measuring range 40 mm
-  Resolution 0.1 μm
-  Measuring rate 2.3 kHz
-  Linearity typ. $\pm 3 \mu\text{m}$
-  **INTER FACE** Analog output 0 to 10 VDC
Serial interface RS232/USB
-  LED light source

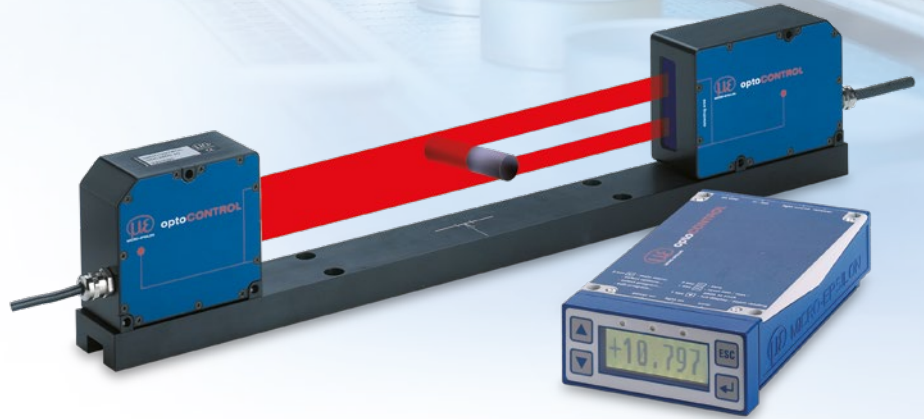

The optoCONTROL 2600 is an optical measuring system with an integrated, high resolution CCD camera. The measurement data received is output via digital or analog interfaces. The micrometer is highly independent of ambient light.

The optoCONTROL 2600 consists of a sensor unit attached to a mounting rail. The sensor unit includes a light source with high-power LED and a receiver with telecentric lens and CCD array. The sensor unit is controlled and evaluated by an intelligent controller with graphic display for operation and readings.

The adjustable light source allows precise measurement of most transparent objects. By combining the LED with the telecentric optics, significantly higher accuracy and repeatability of the measurement data are made possible. The system is insensitive to interferences such as dust or ambient light.

Predefine measurement modes

(6 individual and adjustable programs)

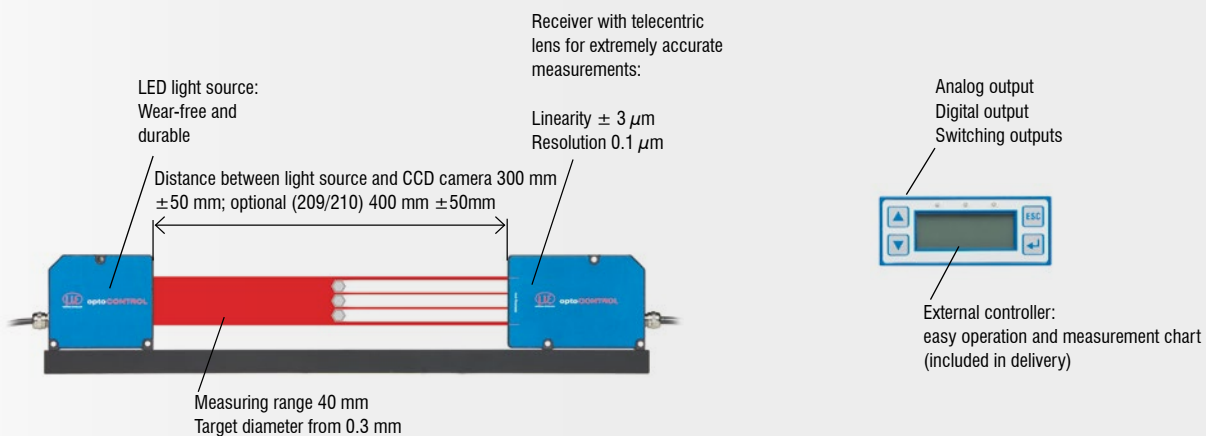
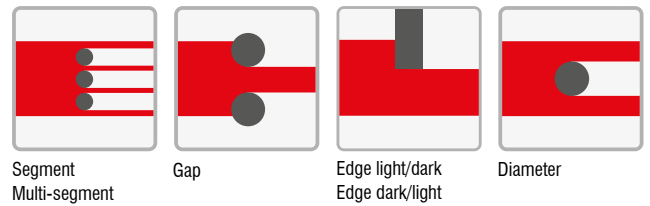

Model		ODC2600-40	ODC2600-40(209)	ODC2600-40(210)
Measuring range		40 mm		
Min. target size		0.3 mm		
Distance light source - receiver (free space) ¹⁾		300 (±50) mm	400 (±50) mm	400 (±50) mm
Measuring distance (target - receiver)		150 (±5) mm	200 (±5) mm	200 (±5) mm
Measuring rate		2.3 kHz		
Resolution ¹⁾		0.1 μm		
Linearity ²⁾		< ±3 μm		
Repeatability ^{2) 3)}		±1 μm	±1.5 μm	±1.5 μm
Light source		red LED 625 nm		
Analog output		0 to 10 VDC, ±10 VDC, selectable		
Digital interface		RS232 (115.2 kBaud); RS422 (691.2 kBaud)		
Switching output		Error, 4x limit values; max. 30V DC ≤ 100 mA		
Signal input		Zero setting/reset; trigger/light (on/off); synchronization		
Digital output		Synchronization ⁴⁾		
Connection	Receiver	integrated cable, length 2 m 12-pole		
	Light source	integrated cable, length 2 m 5-pole		
	Controller	Receiver: 12-pole M8 socket; light source: 5-pole socket for light source Supply: 3-pole socket; signal: 25-pole SUB-D socket		
Mounting		Mounting rail (see accessories), mounting holes		
Temperature range	Storage	-20 °C ... +70 °C (non-condensing)		
	Operation	0 °C ... +50°C (non-condensing)		
Supply voltage		+24 VDC (±15 %)		
Maximum power consumption		< 1 A		
Shock (DIN EN 60068-2-27)		15 g / 6 ms		
Vibration (DIN EN 60068-2-6)		2 g / 20 ... 500 Hz		
Protection class (DIN EN 60529)	Receiver / light source	IP64		
	Controller	IP40		
Material	Receiver / light source	Aluminum housing		
	Light source	450 g		
Weight	Receiver	800 g		
	Controller	1200 g		
	Mounting rail	900 g	1100 g	-
Measuring programs		Edge light-dark; edge dark-light; (outside) diameter/width; gap/(inside diameter); any segment edge		
Control and indicator elements		LCD display (value, maximum, minimum, peak-to-peak) measurement chart in mm / inch, selectable; menu language in German / English, selectable; 3x LEDs (power on, light on, error)		
Special features		4 editable user programs		

The specified data apply for a consistent room temperature of 20 °C, after a warm-up time of 30 min.

¹⁾ Resolution of the digital display (resolution of digital output 0.6 μm)

²⁾ Measured with 3 sigma; edge measurement without averaging, working distance 150±5 mm, option 209/210: 200 mm ± 5 mm

³⁾ Measured with static noise over 3 min.

⁴⁾ Only for synchronization of two or more optoCONTROL 2600 models

Interface modules and accessories

optoCONTROL

XFrame2520 for 2-axis measurements

Accessory for the integration of optical ODC2520-46 micrometers for diameter measurements

- 2-axis frame for X-arrangement of 2 sensors
- Optics can be cleaned with compressed air
- e.g. for wires, cables, tubes, rods or flat steel
- Objects up to 46 mm diameter measurable
- Measuring range 46 x 46 mm
- Evaluation of the two sensors via universal controller possible (not included in scope of delivery)



Various ODC tools for ODC2520 and ODC2600

Depending on the sensor, diverse tools for continuous measurement value recording and parameter set up are available free of charge

- ODC2600 & ODC2500 Tool: For parameterization and continuous recording of measured values.
- SensorTOOL: The measured values of one or more micrometers can be graphically displayed and recorded simultaneously.



Interface modules

Module	ODC1200	ODC2520	ODC2600
IF2001/USB RS422/USB converter to transform a digital signal to USB	⊘	✓	✓
IC2001/USB Single-channel RS422/USB converter cable	⊘	✓	✓
IF2004/USB RS422/USB converter to convert up to 4 digital signals to USB	⊘	✓	✓
IF2008/ETH Interface module for Ethernet connection for up to 8 sensors	⊘	✓	⊘
IF2008PCIE Interface card for multiple sensor signals; analog and digital interfaces	✓	✓	✓
IF2035-EtherCAT Interface module for Industrial Ethernet connection (EtherCAT)	⊘	✓	⊘
IF2035/PROFINET Interface module for Industrial Ethernet connection (PROFINET)	⊘	✓	⊘
IF2035/EtherNetIP Interface module for Industrial Ethernet connection (EtherNet/IP)	⊘	✓	⊘
IF1032/ETH Interface module for connecting the analog interface to Ethernet or Industrial Ethernet (EtherCAT)	✓	⊘	⊘

IF2001/USB converter RS422 to USB

The RS422/USB converter converts the digital signals of an optical micrometer into a USB data packet. The sensor and the converter are connected via the RS422 interface of the converter. Data output is done via USB interface. The converter loops through further signals and functions such as laser on/off, switch signals and function output. The connected sensors and the converter can be programmed through software.

Special features

- Robust aluminum housing
- Easy sensor connection via screw terminals (plug and play)
- Conversion from RS422 to USB
- Supports baud rates from 9.6 kBaud to 12 MBaud

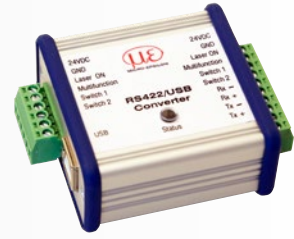

IC2001/USB Single-channel converter cable RS422/USB

The IC2001/USB single-channel converter cable is used for the USB connection of optoCONTROL sensors equipped with an RS422 interface. The cable is easy to assemble and can therefore also be used for installation in machines and systems.

Special features

- 5-core interface cable without outer shield
- Conversion from RS422 to USB
- Easy sensor connection via USB
- Supports baud rates from 9.6 kBaud to 1 MBaud



IF2004/USB: 4-channel converter from RS422 to USB

The RS422/USB converter is used for transforming digital signals from up to four precision micrometers into USB data signals. The converter has four trigger inputs and a trigger output for connecting additional converters. Data is output via an USB interface. The connected sensors and the converter can be programmed through software. The COM interfaces can be used individually and can be switched.

Special features

- 4x digital signals via RS422
- 4x trigger inputs, 1x trigger output
- Synchronous data acquisition
- Data output via USB

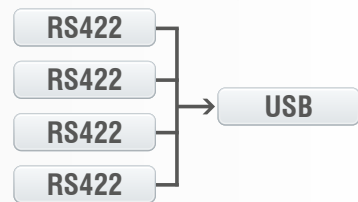

IF2008/ETH

IF2008/ETH Interface module for Ethernet connection with up to 8 sensors

The IF2008/ETH integrates up to eight sensors and/or encoders with an RS422 interface into an Ethernet network. Four programmable switching in-/outputs (TTL and HTL logic) are available.

Ten indicator LEDs directly on the module show both the channel and the device status. In addition, acquisition and output of data via Ethernet is in addition performed at high speeds up to 200 kHz. Parameter setting of the interface module can be easily done via the web interface.



Interface modules and accessories

optoCONTROL

IF2008PCIe/IF2008E

Interface card for synchronous data acquisition

Absolute synchronous data acquisition is a decisive factor for the deflection or straightness measurement using several laser sensors. The IF2008PCIe interface card is designed for installation in PCs and enables the synchronous capture of four digital sensor signals and two encoders. The data is stored in a FIFO memory in order to enable resource-saving processing in blocks in the PC. The IF2008E expansion board enables to detect in addition two digital sensor signals, two analog sensor signals and eight I/O signals.

Special features

- IF2008PCIe - Basic printed circuit board: 4 digital signals and 2 encoders
- IF2008E - Expansion board: 2x digital signals, 2x analog signals and 8x I/O signals

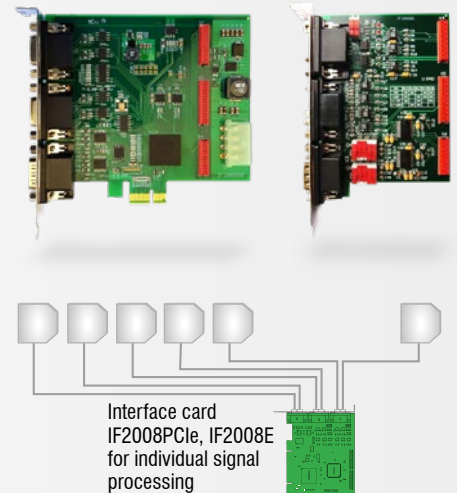

IF2035

Interface module for Industrial Ethernet connection

The IF2035 interface modules are designed for easy connection of Micro-Epsilon sensors to Ethernet-based fieldbuses. The IF2035 is compatible with sensors that output data via an RS422 or RS485 interface and supports the common Industrial Ethernet protocols EtherCAT, PROFINET and EtherNet/IP.

These modules operate on the sensor side with up to 4 MBd and have two network connections for different network topologies. In addition, the IF2035-EtherCAT offers a 4-fold oversampling function, which enables faster measurements than the bus cycle allows, if required. Installation in control cabinets is via a DIN rail.

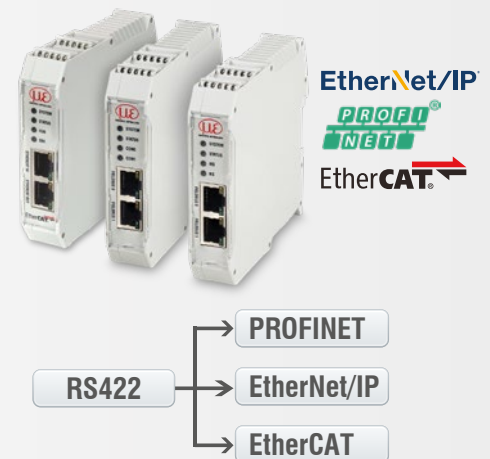

IF1032/ETH







The IF1032/ETH interface module now enables to run micrometers equipped with analog interfaces with the proven operating concept based on a web interface. The Ethernet interface permits to easily display the measured data on a PC. Moreover, micrometers can be connected to an EtherCAT bus. The RS485 interface allows to connect new micrometers that use the Micro-Epsilon specific RS485 protocol.

Interfaces













- Ethernet/EtherCAT
- 1x RS485 (ME-internal protocol)
- 2x analog-in (14 bit, max. 4 ksps), voltage
- 1x analog-in, (14 bit, max. 4 ksps), current
- Inputs for supply voltage
- Trigger input
- EtherCAT synchronization output
- Output for sensor power supply



optoCONTROL 1200/1201

Connection	Interface modules	Connection cables	Mounting	Accessories
Power supply Power supply unit PS2031 2420096 Power supply unit PS2020 2420062		Power supply and signal cables PC1200/90-5 (5 m) (90°) 2901261 PC1200-5 (5 m) 2901260 PC1200-10 (10 m) 2901483		Adjustment plate <u>Receiver</u> JU1200-HR (horizontal) 2966018 JU1200-VR (vertical) 2966019 <u>Transmitter</u> JU1200-VT (vertical) 2966020 JU1200-HT (horizontal) 2966021
Digital output / Ethernet / EtherCAT 	IF1032/ETH 2420066 max. 4 kSps 			 (for 1200 and 1200/90)
PLC Analog Connection via 0 ... 10 V 	Direct 0 - 10 VDC		Mounting rail for C-frame mounting ODC1202-L100 (L=0.4 m) 2966006 ODC1202-L200 (L=0.5 m) 2966007 ODC1202-L500 (L=0.8 m) 2966008  (for 1200 and 1200/90)	Bracket for C-frame mounting BR1200L220 (L=220 mm) 2966024 BR1200L320 (L=320 mm) 2966025























optoCONTROL 2600

Connection	Interface modules	Connection cables	Mounting	Accessories
Power supply Power supply unit PS2031 2420096 Power supply unit PS2020 2420062		Supply cables (open) PC2500-3 (3 m) 2901123 PC2500-10 (10 m) 2901124		Demo prism incl. testing pins 9335380 
Serial or analog connection to PC or PLC 	Direct 0 - 10 VDC Direct RS232 SUB-D9 Direct RS422 SUB-D9 Direct RS422 OE	Output cables IO analog SCA2500-3 (3 m analog) 2901120 SCA2500-10 (10 m analog) 2901215 Signal output cables serial RSxxx SCD2500-3/3/RS232 (3 m) 2901121 (analog + signals / 3 m RS232) SCD2500-3/10/RS422 (3 m) 2901122 (analog + signals / 10 m RS422) SCD2500-3/RS422 2901111 (3 m only RS422 open ends)		Diameter of testing pins - 20 mm - 10 mm - 6 mm - 3 mm
USB 	IF2004/USB 2213024 4-port RS422  IC2001 / USB 2213041  IF2001/USB converters 2213025 	Signal output cable SCD2500-3/10/RS422 (3 m) 2901122 (analog + signals / 10 m RS422) IF2008-Y-adaptor cable (0.1 m) 2901528 For the connection of a 3rc  Signal output cables SCD2500-3/RS422 (3 m) 2901111 (only RS422 open ends)		Extension cable For controller receiver units: CE1800-3 (3 m) 2901057 CE1800-8 (8 m) 2901058 For controller light sources: CE2500-3 (3 m) 2901118 CE2500-8 (8 m) 2901119
Digital output PCIE Card installation 	IF2008PCIE 2213032  IF2008E 2213032 	Interface cables for IF2008 SCD2500-3/IF2008 (3 m) 2901561 SCD2500-8/IF2008 (8 m) 2901563 IF2008-Y-adaptor cable (0.1 m) 2901528 For the connection of a 3rd or 4th sensor 		

Interface module and accessories

optoCONTROL

optoCONTROL 2520

Connection	Interface modules	Connection cables	Mounting	Accessories
Power supply 2420096 (24V; 1A) 2420062 (24 VDC/2.5 A) Power supply Power supply unit PS2031 2420096 Power supply unit PS2020 2420062		Supply, interface and signal cables with open ends PC/SC2520-3 (3 m) 2901918 PC/SC2520-10 (10 m) 29011037 PC/SC2520-20 (20 m) 29011038 PC/SC2520-30 (30 m) 29011039 PC/SC2520/90-5 (5 m) (90°) 29011003		Demo prism incl. testing pins 9335426  Diameter of testing pins - 20 mm - 10 mm - 6 mm - 3 mm
PLC ProfiNET / EthernetIP 	IF2035-EtherCAT 2211036 IF2035-PROFINET 2211039 IF2035-EtherNetIP 2211038 			
Serial RS422	Direct RS422 OE to PC		 	
Analog 0 ... 10 V	Direct 0-10 VDC			
Digital output / USB / Ethernet 	IC2001/USB 2213041 Converter cable 		 	Mounting rail (0.7 m) 2966033 (1.0 m) 2966034 (1.5 m) 2966035
	IF2001/USB 2213025 Converter 			
Serial RS422	Direct RS422 to PC			
Analog 0-10 VDC	Direct 0-10 VDC			
	IF2004/USB 2213024 	Interface and supply cables for IF2008; PC/SC2520-3/IF2008 (3 m) 		
	IF2008PCIE 2213032 	IF2008-Y adapter cable for connection of a 3rd or 4th sensor (0.1 m) 		
	IF2008E 2213018 			
Ethernet	Directly via Ethernet to PC via RJ45	Digital output cables SCD2520-3 (3 m) 2901925		
EtherCAT 	Directly via RJ45	SCD2520-5 (5 m)(90°) 29011002 SCD2520-8 (8 m) (90°) 29011042		
	Optional for connecting multiple 2520 sensors EK1122 2-port junction EK1100 Bus coupler			
	via EtherCAT Switch M12	SCD2520-5 M12 (5 m) 29011040		
Digital output Ethernet 	IF2008ETH 2213018 	Supply and output cable, PCE2520-3/M12 (3m) 29011343 	Connection Transmitter / Receiver CE2520-1 (1 m) 2901919 CE2520-2 (2 m) 2901920 CE2520-5 (5 m) 2901921  CE2520/90-1 (1 m) 90° 2901922 CE2520/90-2 (2 m) 90° 2901923 CE2520/90-5 (5 m) 90° 2901924	

PS2020 Power supply unit
PS2031 Power supply unit

24 VDC / 2.5 A for mounting on DIN rail
Universal power supply unit 100-240V/24V/ 1A

2420062
2420096



Basics & selection criteria

optoCONTROL

All sensors of the optoCONTROL series operate according to the shadow casting / ThruBeam principle. A cross section of the contour of a target is measured with high accuracy. Three types of ThruBeam technologies are used in the different optoCONTROL series to cover a wide range of applications.

Light quantity measurement (ODC1200/1201)

In light quantity measurement, an optical system fans the light from a red laser diode to create a parallel light curtain. The light curtain is aligned with the receiver unit. In the receiver unit, a precision aperture guides the light through various filters and optical components onto a light-sensitive detector. An analog electronic system processes the amount of incident light and outputs this data as an analog signal.

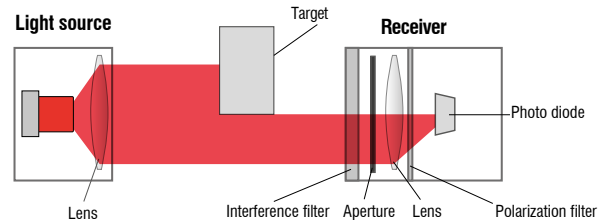

Colometry ODC25xx

Colometry is a laser-based measuring system with an integrated high-resolution line scan camera for measuring geometric quantities. It measures the dimension of a target or the position of an edge on a body using the shadowing principle. A parallel light curtain is generated with a laser light source. The camera in the receiver unit measures the contour of the target using the shadow generated on the pixel-based array.



Telecentric method ODC2600

The telecentric method is a measuring system with an integrated high-resolution line scan camera. The light source illuminates the target from behind. There is a telecentric objective lens in the receiver. It provides an image of the same size in the so-called telecentric range and produces a constant accuracy. The advantages of the telecentric lens are the free positioning of the target within the telecentric range (± 5 mm) and the relatively high tolerance to contamination and ambient light. The line scan camera in the receiver also measures the projected outer contour of the target.

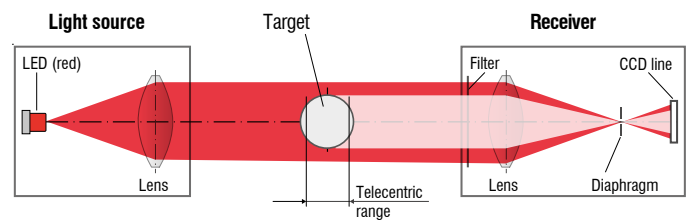

LASER RADIATION
DO NOT VIEW DIRECTLY
WITH TELESCOPE OPTICS
CLASS 1M LASER PRODUCT
IEC 60825-1: 2014
P<2mW, Es<0.2mW/cm², λ=670nm

optoCONTROL 2520 uses a semiconductor laser, 670nm \leq 2mW max. optical power, laser class 1M. No additional protective measures are required for the use of these devices. Be careful with the dazzling effect related to optical instruments.



Class 1 Laser Product
IEC 60825-1: 2014
P<0.39 mW; λ=670 nm
COMPLIES WITH 21 CFR 1040.10 AND 1040.11
EXCEPT FOR CONFORMANCE WITH IEC 60825-1
ED. 3 AS DESCRIBED IN
LASER NOTICE NO. 56, DATED MAY 8, 2019.

optoCONTROL 12xx uses a semiconductor laser, 670 nm, \leq 0.39 mW max. optical power, laser class 1. No additional protective measures are required for the use of these devices.



Sensors and systems for displacement, distance and position



Sensors and measurement devices for non-contact temperature measurement



Measuring and inspection systems for metal strips, plastics and rubber



Optical micrometers and fiber optics, measuring and test amplifiers



Color recognition sensors, LED analyzers and inline color spectrometers



3D measurement technology for dimensional testing and surface inspection