



SCIGATE AUTOMATION (S) PTE LTD

No.1 Bukit Batok Street 22 #01-01 Singapore 659592

Tel: (65) 6561 0488

Fax: (65) 6562 0588

Email: sales@scigate.com.sg

Web: www.scigate.com.sg

Business Hours: Monday - Friday 8.30am - 6.15pm

More Precision.

Optical gauges // Metal industry - aluminum

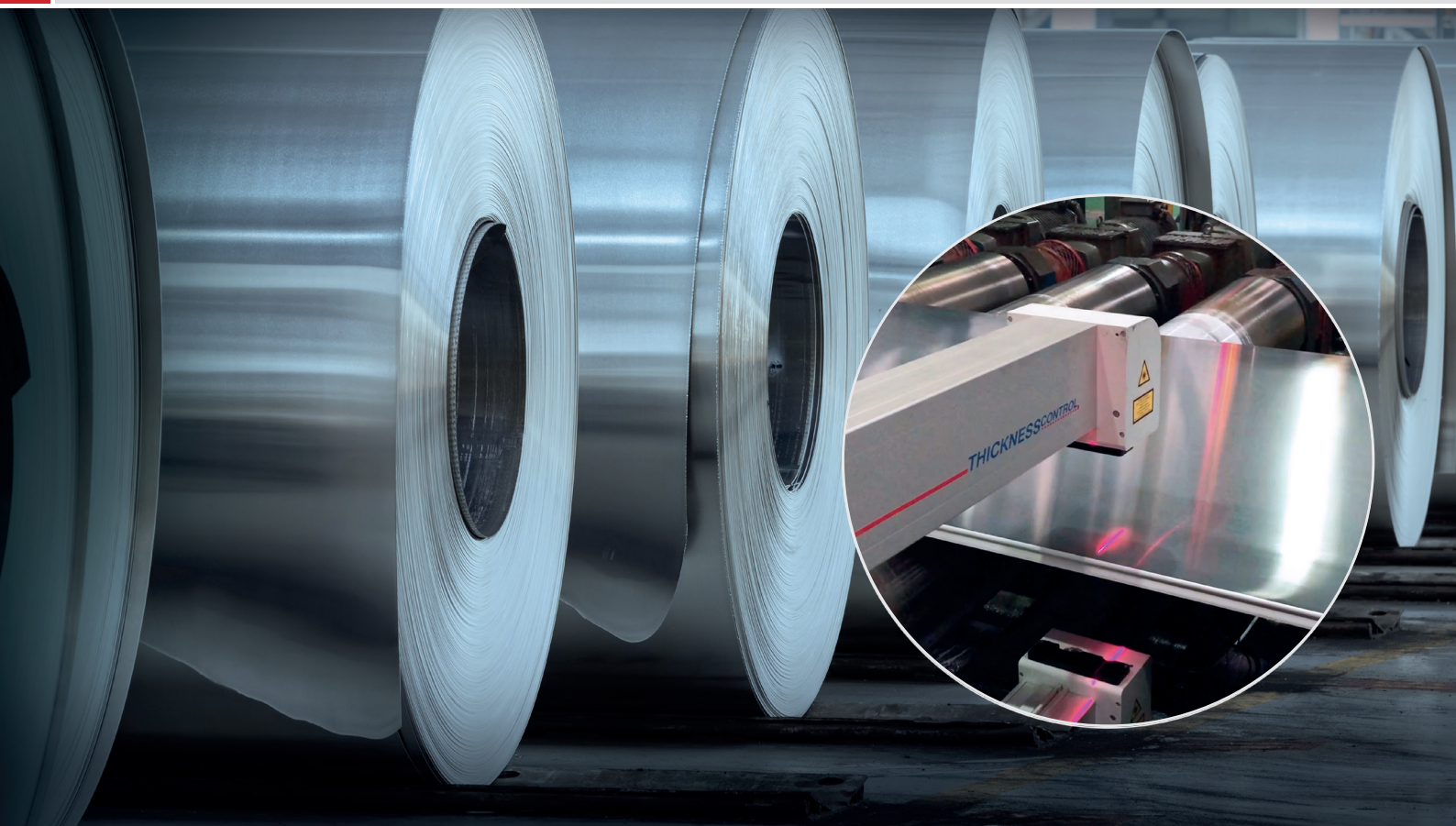

Optical gauges for the metal industry

References

References (extract)

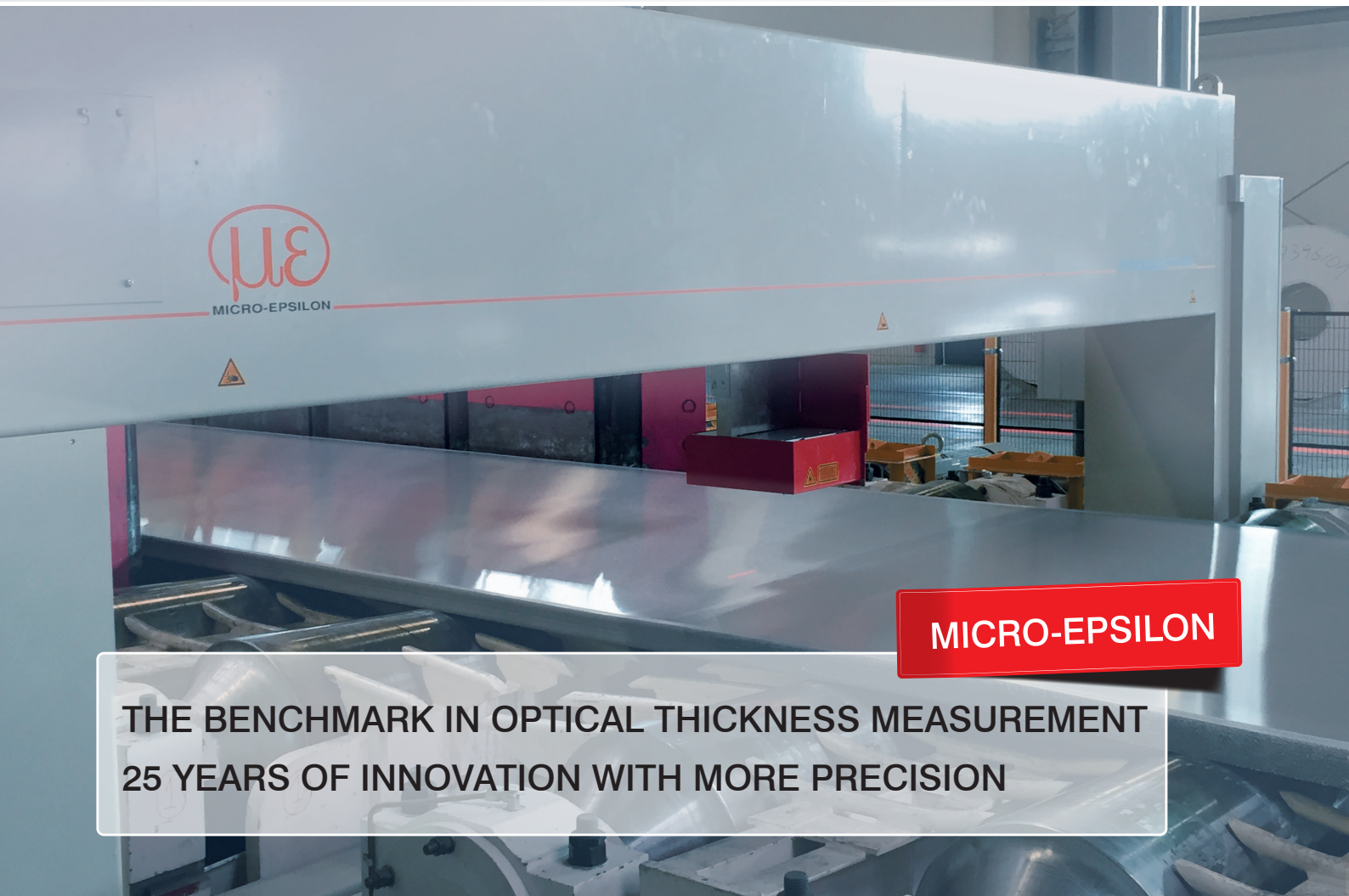

MICRO-EPSILON

**THE BENCHMARK IN OPTICAL THICKNESS MEASUREMENT
25 YEARS OF INNOVATION WITH MORE PRECISION**

Measured features



-  **THICKNESS**
-  **CENTER THICKNESS**
-  **EDGE DROP**
-  **THICKNESS PROFILE**
-  **WEDGE AND CROWN BOW**
-  **WIDTH**

Overview



**Optical gauges
for the metal industry**
Fields of application / Technical data
Page 4 - 5



Cold rolling mills
thicknessCONTROL MTS 8202.K
Page 10 - 11



Hot rolling mills
thicknessCONTROL MTS 9202.LLT
Page 6 - 7

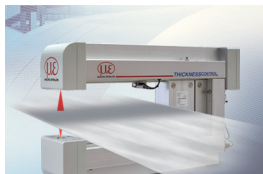

Processing lines / Service Centers
thicknessCONTROL MTS 8202.LLT
Page 12 - 13







Hot rolling mills
thicknessCONTROL MTS 9201.LLT
Page 8 - 9



Processing lines / Service Centers
thicknessCONTROL MTS 8201.LLT
Page 14 - 15

Optical gauges for the metal industry

Fields of application / Technical data

-  **HOT ROLLING MILLS**
-  **COLD ROLLING MILLS**
-  **PROCESSING LINES**
-  **SERVICE CENTERS**

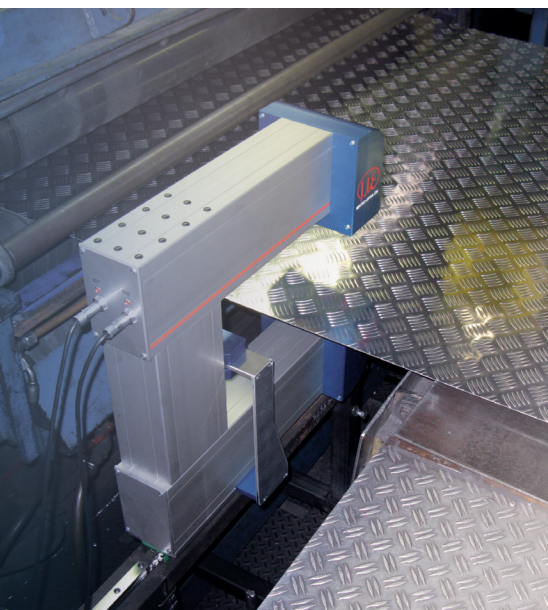

C-frame measurement on checker plate

Operating principle of thickness measurement

The principle of dimensional, geometric thickness measurement includes one optical distance sensor on each side of the material. The distance (=operating range) of both sensors is determined in a calibration process based on a certified measurement standard of which the thickness is added to the sum of the sensor signals in order to determine the current operating range. A 2D sensor not only processes one measuring point.

In the calibration process described above, the coordinate systems of the sensors installed in the upper and lower belts are synchronized. For thickness measurement during production, the difference between the sum of the distance signals and the value of the operating range is determined. The systems are mechanically designed in C-frame or O-frame shape. Both lasers must be projected congruently onto the top side and the rear side of the material in order to achieve an accurate thickness measurement. The sensors are factory-calibrated using an optoelectronic tool and a patented procedure, i.e. the linearity deviation is determined across the entire working range and a correcting function is calculated.

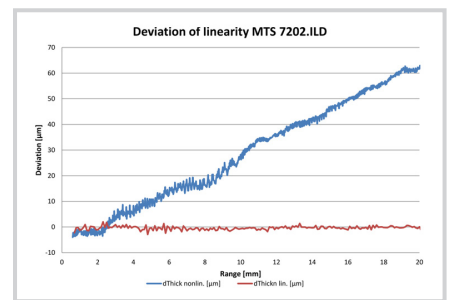

Linearity deviation (accuracy) before and after factory calibration

Innovative "Discrete laser line"

When talking about optical thickness measurement, conventional laser point sensors, confocal chromatic point sensors and laser line sensors (=profile sensors/laser scanners) have to be distinguished. Unlike point sensors, laser line sensors use a static laser line which they project onto the surface of the measuring object. A high quality optical system projects the diffusely reflected light of this laser line onto a highly sensitive sensor matrix which detects during one measurement, depending on the sensor, a profile with 640 or 1280 measuring points. From this matrix image, the integrated controller calculates the distance information (z-axis) and the position alongside the laser line (x-axis) in a two-dimensional coordinate system.



Point cloud diagrams of two laser line sensors

Fields of application / Technical data

Resolution and measuring range

While the resolution of point sensors corresponds to the smallest measurable thickness change, laser line triangulation is much more complex. Here, the resolution is not determined by evaluating one single point but several points or rather an entire profile is taken into account and a reference line is fitted into the point cloud (best-fit-line). Therefore, the resolution is the smallest measurable thickness change between two corresponding reference lines and is consequently higher compared with the point triangulation method using the same optical system, i.e. the same measuring range size. With this effect, thicknessCONTROL MTS 820X.LLT provides a large measuring range at extremely high resolution which is particularly beneficial in slitting line applications.

Robust in harsh, industrial environments

Due to their high data rates, laser line sensors have proven to be very stable in harsh environments. In situations where there is a loss of 50% of the measuring points, e.g. due to steam, residual contamination with mill emulsion or reflections on shiny surfaces, the reference line of the usable point cloud still generates very stable measurement values and is thus superior to laser point technology.

Compensating for strip movement

Compared to laser point sensors, laser line triangulation measurement offers improved accuracy and stability. Tilt angles, warping and deformation of the material to be measured which occur in many processes in the metal industry are recognized using profile sensors and considered in the measurement results. This enables thicknessCONTROL MTS 820X.LLT to provide high quality thickness measurements with accuracies in the micrometer range, even when the metal sheet to be measured is several mm thick and tilted.

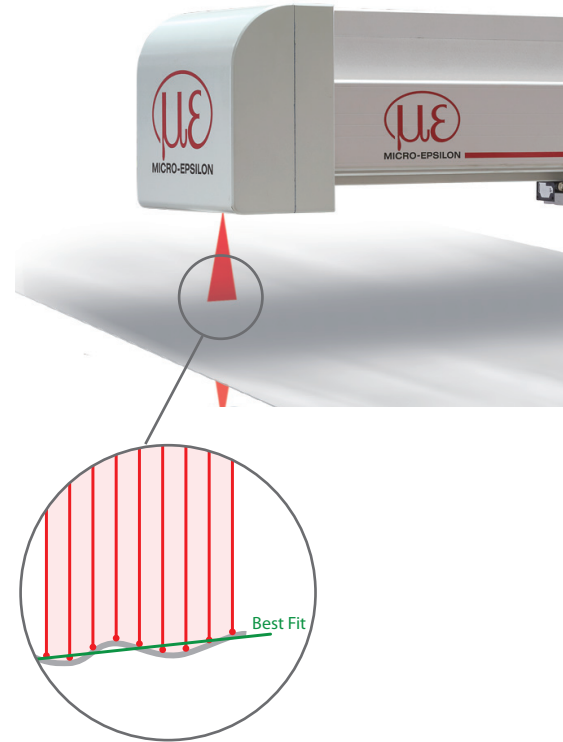

Calculation of the measured value using a reference line

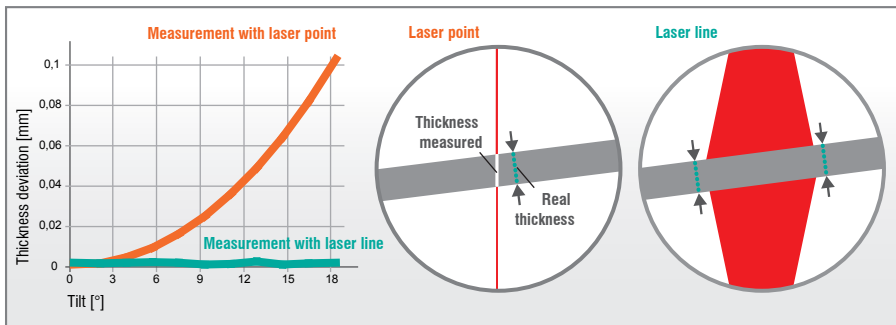

Example of a deviating thickness value due to tilted strip with a material thickness of 4 mm

Automatic calibration & temperature compensation

thicknessCONTROL MTS systems are equipped with in-situ calibration in order to compensate e.g. for the effects of temperature fluctuations. Depending on the respective application, with this calibration either the reference/calibration piece or the C-frame can be positioned. Furthermore, the correct functioning of the system can be cyclically proven at any time. The analysis software enables easy, fast verification of the measuring system's capability, which can be automated depending on the application.



Fully automatic calibration enables long-term measurement stability



Hot rolling mills thicknessCONTROL MTS 9202.LLT

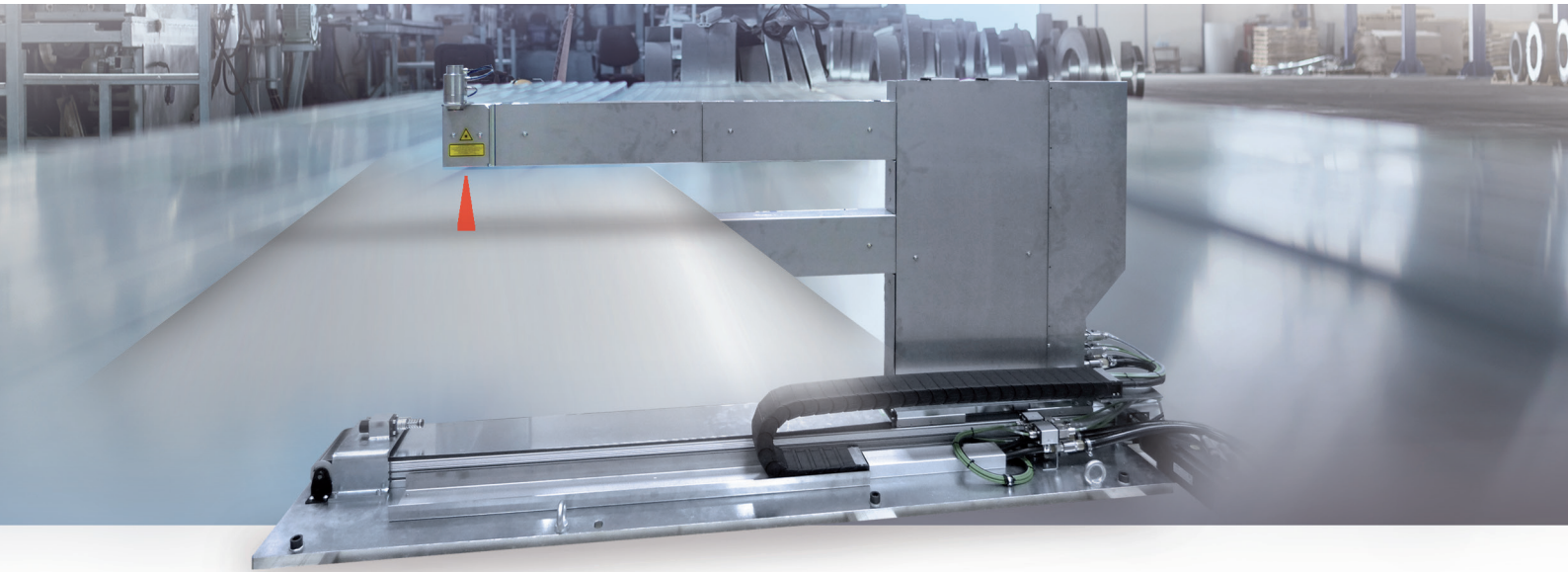

thicknessCONTROL MTS 9202.LLT

The new generation of thickness laser gauges, the thicknessCONTROL 9202.LLT stands for exceptional performance in hot rolling mills.

Intelligent measuring mechanics for high temperatures

The smart mechanics of the MTS9202.LLT series can partially compensate for changes induced by temperature gradients. In addition, a network of temperature sensors stabilizes the measuring range using powerful signal processing.

An additional, regulated cooling register and deflector plates even enable use in aluminum hot rolling mills at material temperatures exceeding 500 °C.

Sequential measuring ranges for more precision and process reliability

The thicknessCONTROL MTS 9202.LLT models with a measuring range of 400 mm are equipped with a special blue laser triangulation sensor which provides two sequential measuring ranges. This covers the varying thicknesses of the rolled material in such a way that measurements can be

performed in the single-digit micrometer range with thinner materials (<100 mm). In addition, this innovative approach ensures significantly increased process reliability due to a very large distance between the passline and the upper belt.

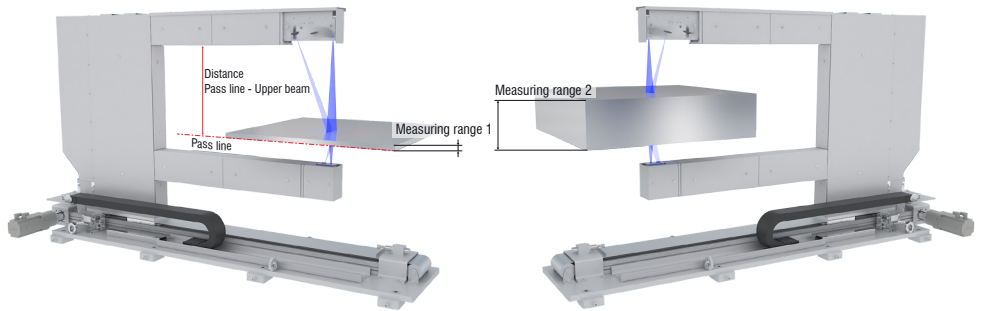

Sequential measuring ranges for large thickness variation



thicknessCONTROL MTS 9202.LLT

Applications

Measurement quantities and possible positions in hot strip mills for systems and sensors from Micro-Epsilon

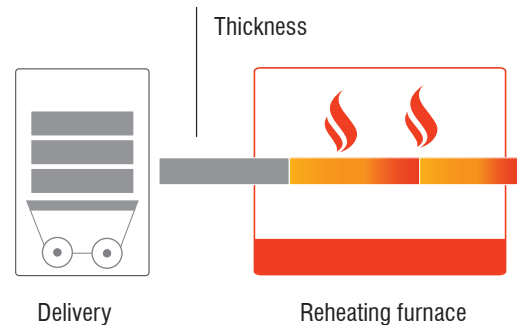

thicknessCONTROL MTS 9202.LLT-60						
Article no.	4350127.301	4350127.302	4350127.303	4350127.304	4350127.305	4350127.306
Measuring width	250 mm	500 mm	1000 mm	1500 mm	2000 mm	2500 mm
Measuring range	60 mm					
Resolution	0.2 μm					
Accuracy ¹⁾	$\pm 2 \mu\text{m}$					
Repeatability ¹⁾	$\pm 0.5 \mu\text{m}$					
Material temperature ³⁾	up to 530 °C					

thicknessCONTROL MTS 9202.LLT-400						
Article no.	4350127.334	4350127.335	4350127.336	4350127.337	4350127.338	4350127.339
Measuring width	250 mm	500 mm	1000 mm	1500 mm	2000 mm	2500 mm
Measuring range 1	100 mm					
Resolution 1	0.5 μm					
Accuracy 1 ¹⁾²⁾	$\pm 10 \mu\text{m}$					
Repeatability 1 ¹⁾	$\pm 1 \mu\text{m}$					
Measuring range 2	100 ... 400 mm					
Resolution 2	2 μm					
Accuracy 2 ¹⁾	$\pm 20 \mu\text{m}$					
Repeatability 2 ¹⁾	$\pm 5 \mu\text{m}$					
Material temperature ³⁾	up to 530 °C					

¹⁾ 2 σ
²⁾ Max. passline deviation 100 mm
³⁾ With further cooling measures

Advantages:

- Patented technology compensates for thermal influences affecting the mechanical frame
- Special sensors with double camera, 400 mm measuring range, accuracy $\pm 10 \mu\text{m}$
- High-performance cooling system for material temperatures exceeding 500 °C
- Pneumatic mechanism protects optical system
- Calibration and measurement independent material and alloy

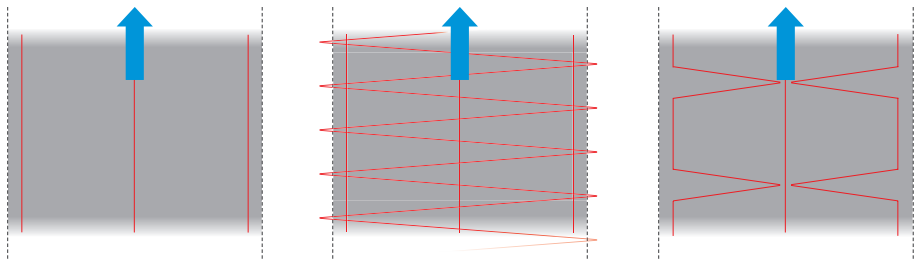

3-track measurement modes

Up to three C-frames of the MTS 9202 series can be operated together. This allows a variety of different measurement modes for edge and center thickness, as well as thickness profile.

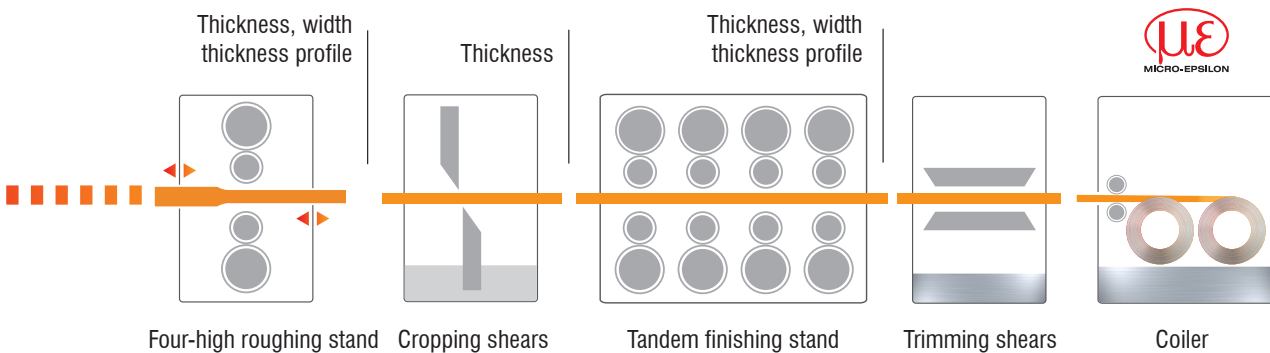



Hot rolling mills thicknessCONTROL MTS 9201.LLT

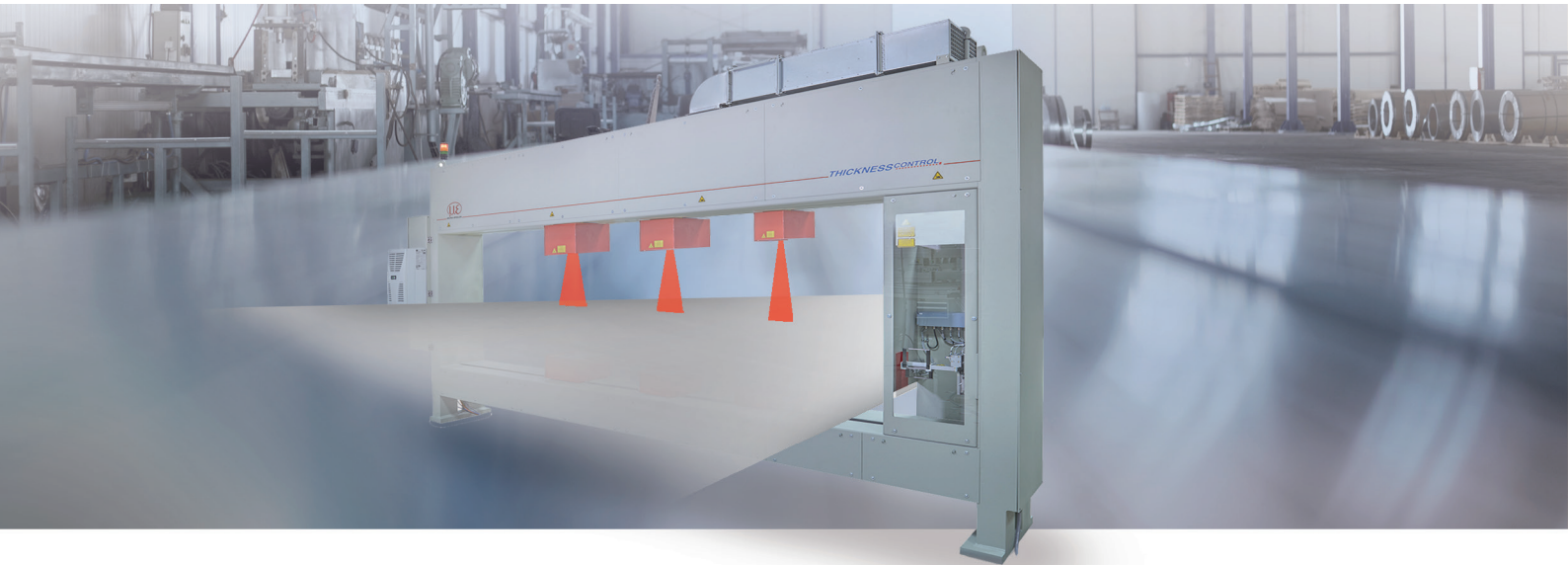

thicknessCONTROL MTS 9201.LLT

Products produced in plate rolling mills are used, for example, in the aerospace and automotive industries. They represent a challenge for isotope and X-ray equipment in terms of measurement technology and costs. The thicknessCONTROL MTS 9201.LLT systems are equipped with special sensor technology and can precisely measure plates with a thickness up to 400 mm in both hot and cold states.

Potential applications for the equipment are behind quarto stands for mill control or quality control. Usually, reversing stands are used at this point, where a single measuring system detects the center thickness. The thicknessCONTROL 9201.LLT systems are also used in shearing lines for final quality assurance.

Robust architecture for the harshest ambient conditions

thickness CONTROL MTS 9201.LLT is specially designed for applications in harshest environments. These systems stand out due to their solid steel frame. The optical sensors are equipped with a water cooling system whereas the frame is purged with cold air so that the integrated, electronic components remain in the specified temperature range. Furthermore, the frame can be equipped with protective plates against heat radiation.

Inside, the MTS 9201 systems have a temperature-stable compensation frame which compensates for the temperature-induced mechanical changes based on a patented process.

Extendable to up to 5 measuring tracks

For typical applications in shearing lines, where three tracks are measured along the sheet, as well as the width and length of the sheet, thicknessCONTROL MTS 9201.LLT can be expanded to up to five measuring units that can be moved independently of each other.



Patented frame-in-frame technology with integrated reference frame to compensate for temperature-induced effects

Applications

Measurement quantities and possible positions in plate rolling mills for systems and sensors from Micro-Epsilon



Delivery



Reheating furnace

Advantages:

- Patented technology compensates for thermal effects on the mechanical frame
- Special sensor technology with double camera, measuring range of 400 mm, accuracy $\pm 10 \mu\text{m}$
- High-performance cooling system for material temperatures exceeding $500 \text{ }^\circ\text{C}$
- Pneumatic mechanism protects optical system
- Calibration and measurement independent material and alloy

thicknessCONTROL MTS 9201.LLT-60						
Article no.	4350006.51	4350006.52	4350006.53	4350006.54	4350006.55	4350006.56
Measuring width	500 mm	1000 mm	1500 mm	2000 mm	2500 mm	3000 mm
Measuring range	60 mm					
Resolution	0.2 μm					
Accuracy ¹⁾	$\pm 2 \mu\text{m}$					
Repeatability ¹⁾	0.5 μm					
Material temperature	up to 530 °C					

thicknessCONTROL MTS 9201.LLT-400						
Article no.	4350006.57	4350006.58	4350006.59	4350006.60	4350006.61	4350006.62
Measuring width	500 mm	1000 mm	1500 mm	2000 mm	2500 mm	3000 mm
Measuring range 1	100 mm					
Resolution 1	0.5 μm					
Accuracy 1 ¹⁾²⁾	$\pm 5 \mu\text{m}$					
Repeatability 1 ¹⁾	$\pm 1 \mu\text{m}$					
Measuring range 2	100 ... 400 mm					
Resolution 2	2 μm					
Accuracy 2 ¹⁾	$\pm 20 \mu\text{m}$					
Repeatability 2 ¹⁾	$\pm 5 \mu\text{m}$					
Material temperature ³⁾	up to 530 °C					

¹⁾ 2 σ

²⁾ Max. passline deviation 100 mm

³⁾ With further cooling measures

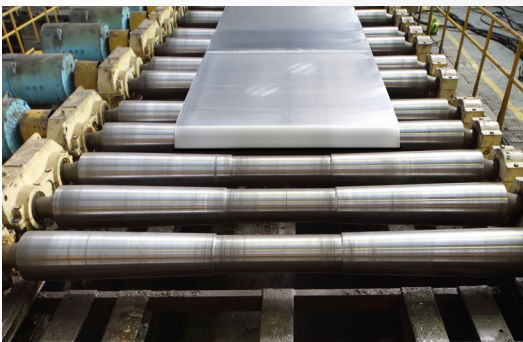

Applications with sensor technology from Micro-Epsilon

Measuring and monitoring the position of aluminum blocks using optoNCDT ILR

Advantages:

- Filter glass for shiny targets
- Large measuring range
- Short response time
- High signal stability on all surfaces

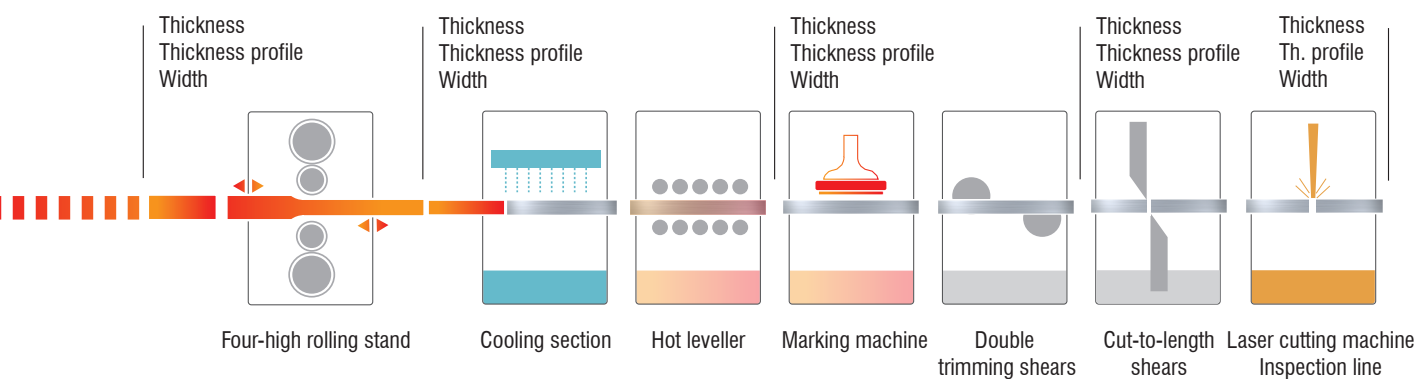



Cold rolling mills thicknessCONTROL MTS 8202.K

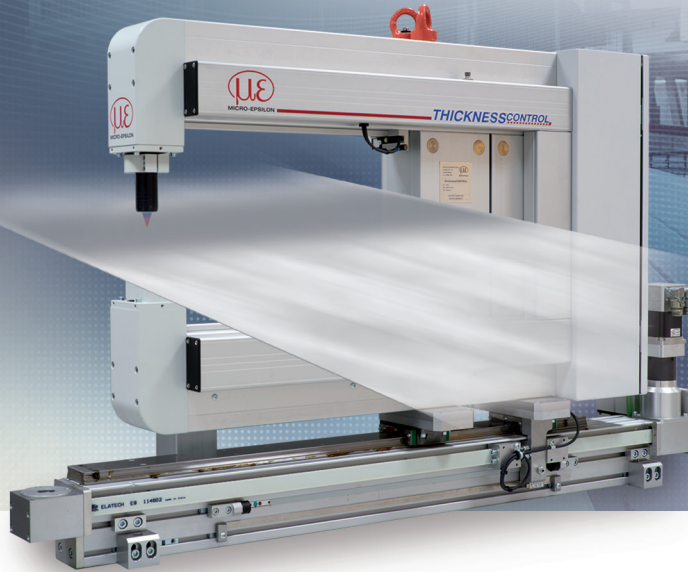

Thickness measurement for control and quality inspection is an important element in the process landscape of cold rolling mills. Common places of application for thicknessCONTROL MTS 8202.K systems for detecting the center thickness or the cross-profile are strip entry or exit of tandem mills or single mill stands.

Confocal technology for highest precision

The thicknessCONTROL MTS 8202.K C-frames are equipped with confocal chromatic sensors.

These focus polychromatic light (white light) onto the target surface through a lens system and disperse the light in monochromatic wavelengths. In the sensor system, this wavelength of light is used for the measurement, which is exactly focused on the target. An optical arrangement images the light reflected onto a light sensitive sensor element, on which the corresponding spectral color is detected and evaluated. This technology enables accuracies down to $\pm 0.3 \mu\text{m}$.

Robust design for challenging environments

Confocal chromatic sensors are passive and can therefore be used with material temperatures up to 70 °C without additional cooling. The systems can be equipped with pneumatic guards which keep the optics of the high-precision sensors clean.



thicknessCONTROL MTS 8202.K

Advantages:

- High data rate up to 6.5 kHz, ideal for performant signal processing
- Ideal for reflective surfaces
- Measuring angle up to 48 °C tolerates tilted materials
- Integrated calibration compensates for thermal effects within seconds

Applications

Measurement quantities and possible positioning in cold and single stand mills for systems and sensors from Micro-Epsilon

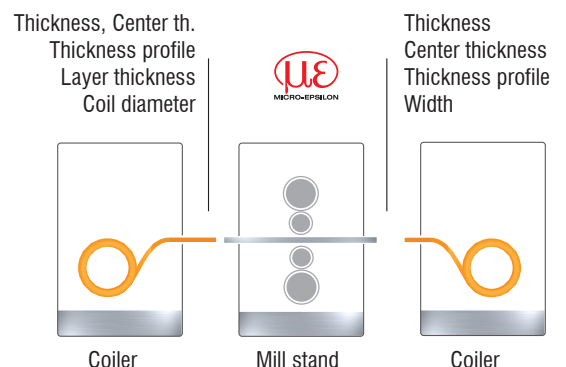

thicknessCONTROL MTS 8202.K								
Article no.	4350127.410	4350127.41	4350127.44	4350127.411	4350127.42	4350127.45	4350127.43	4350127.46
Measuring width	250 mm			500 mm			1000 mm	
Measuring range	3 mm	10 mm	30 mm	3 mm	10 mm	30 mm	10 mm	30 mm
Resolution	0.07 μm	0.12 μm	0.36 μm	0.07 μm	0.12 μm	0.36 μm	0.12 μm	0.36 μm
Accuracy ¹⁾	$\pm 0.4 \mu\text{m}$	$\pm 0.7 \mu\text{m}$	$\pm 2.5 \mu\text{m}$	$\pm 0.4 \mu\text{m}$	$\pm 0.7 \mu\text{m}$	$\pm 2.5 \mu\text{m}$	$\pm 0.7 \mu\text{m}$	$\pm 2.5 \mu\text{m}$
Repeatability ¹⁾	$\pm 0.3 \mu\text{m}$	$\pm 0.5 \mu\text{m}$	$\pm 2 \mu\text{m}$	$\pm 0.3 \mu\text{m}$	$\pm 0.5 \mu\text{m}$	$\pm 2 \mu\text{m}$	$\pm 0.5 \mu\text{m}$	$\pm 2 \mu\text{m}$
Material temperature ²⁾	up to 70 °C							

¹⁾ 2 σ

²⁾ without additional cooling

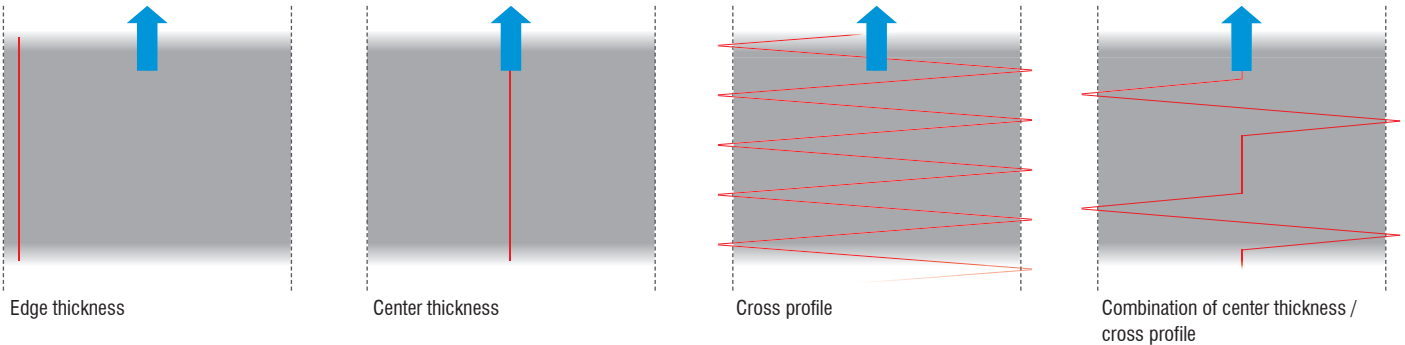

1-track measurement mode

When choosing a C-frame, the measurement width plays an important role. If only the edge is to be measured, the smallest measuring width is sufficient. When measuring the center thickness, the measuring width must correspond to 50 percent of the material width. If the cross profile is to be measured, the measuring width must correspond to the maximum material width.

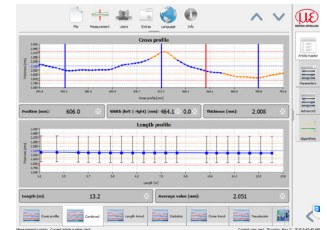

Screenshot cross-sectional and length trend



Analysis and control software

All systems for thickness measurement - regardless of the mechanical design and the sensor technology used - are equipped with the thicknessCONTROL MTS software package. Therefore, they are all based on the same multi-touch-capable operating concept that enables a wide variety of measurement modes. In addition to control and signal processing, functionalities such as article database, production archive, statistical evaluations and limit monitoring can be used. The systems can be fully integrated into the line via a corresponding interface, so that no input is required to operate the system.

Applications

Measurement quantities and possible positioning in cold and tandem mills for systems and sensors from Micro-Epsilon

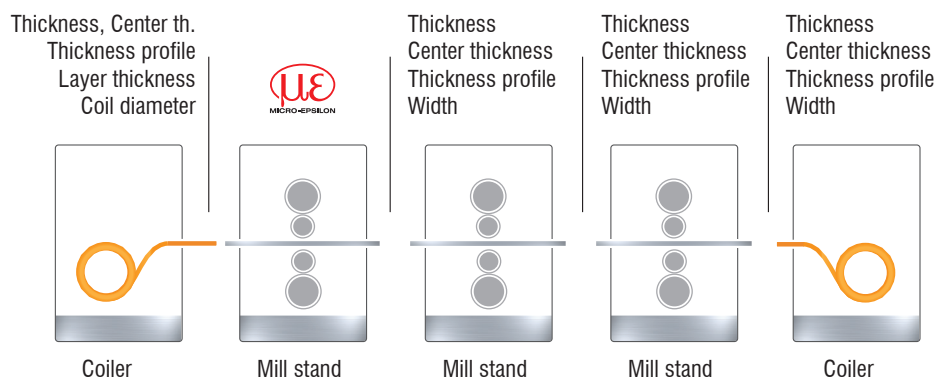



Processing lines / Service Centers thicknessCONTROL MTS 8202.LLT

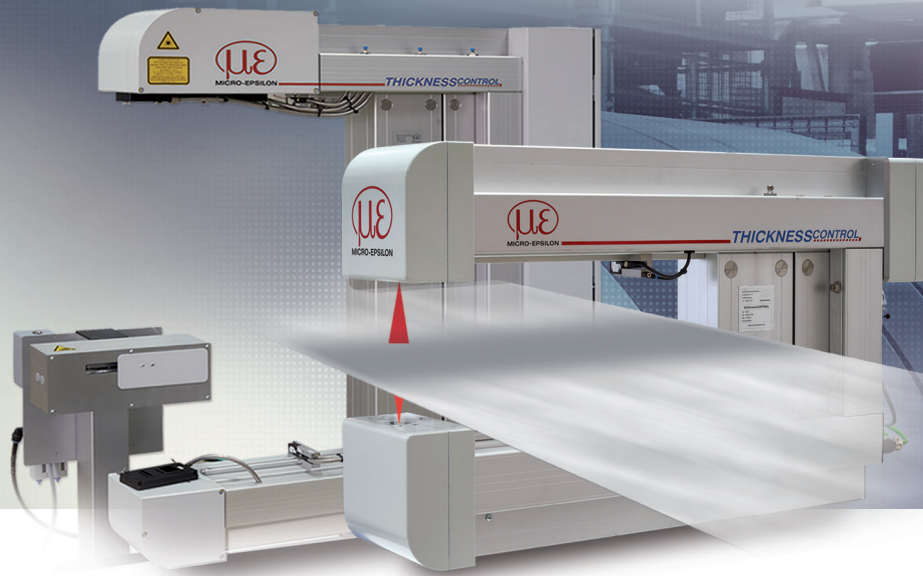

thicknessCONTROL MTS 8202.LLT

In many processes, thickness is one of the most important geometric features. The thicknessCONTROL MTS 8202.LLT systems are successfully used in a variety of applications. The C-frames are equipped with sensors that operate on the basis of discrete laser line technology. They are suitable for harsh environments and complex (galvanized) surfaces. The redundancy of the high data rate provides reliable measurements, even when interferences due to steam as well as emulsion and high gloss surfaces are present.

In cut-to-length or slitting shears, the thickness is measured to ensure the dimensional accuracy of the goods to be processed, e.g. during incoming goods inspection, or to document it as part of quality assurance or for the customer.

Synchronization of up to three systems

Up to three thicknessCONTROL MTS 8202.LLT systems can be operated on one controller. This can be used to measure up to three tracks at fixed positions along a sheet. Two systems can be used to measure the coating thickness, for example in a painting line. For this purpose, one C-frame is placed before and one after the coating and both systems are synchronized via the displacement signal. Thus, the measured values can be assigned to measure the layer thickness.

Application-specific flexibility with more precision

If the lateral resolution of the laser line sensors is not sufficient to achieve the required accuracy with additional measured variables, the thicknessCONTROL MTS 8202.LLT systems can be extended with other

technologies. Up to three laser micrometers are integrated, for example, to precisely measure the width or the cambering. Their arrangement is calibrated inline to compensate for thermally induced change in mechanics.

PATENTED



Additional measurement of width and cambering with patented compensation of tolerance-induced effects

Applications

Measurement quantities and possible positioning for systems and sensors from Micro-Epsilon in slitting lines

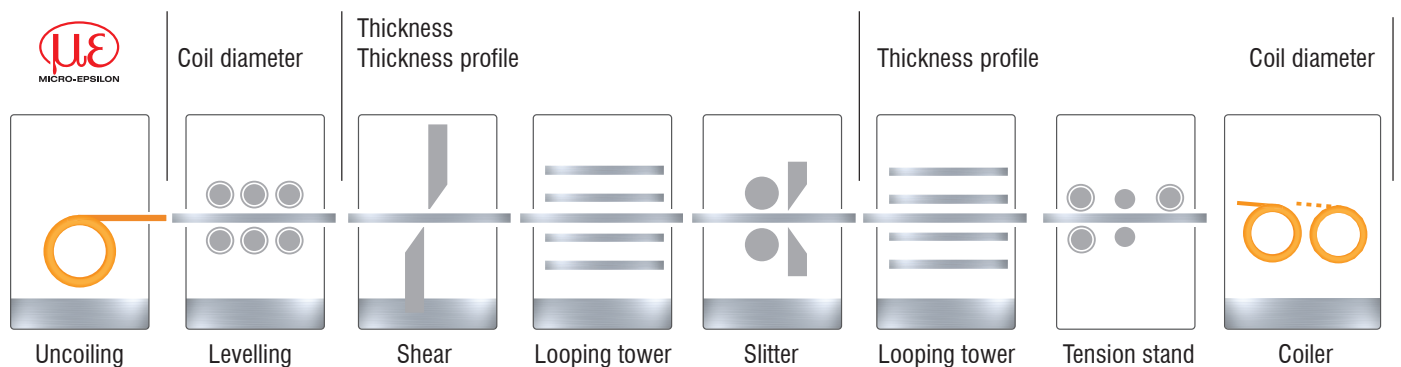

thicknessCONTROL MTS 8202.LLT

Article no.	4350127.21	4350127.22	4350127.23	4350127.24	4350127.71	4350127.72
Measuring width	250 mm		500 mm		1000 mm	
Measuring range 1	60 mm	100 mm	60 mm	100 mm	60 mm	100 mm
Resolution 1	0.2 μm	0.5 μm	0.2 μm	0.5 μm	0.2 μm	0.5 μm
Accuracy 1 ¹⁾	$\pm 2 \mu\text{m}$ ¹⁾	$\pm 10 \mu\text{m}$ ¹⁾²⁾	$\pm 2 \mu\text{m}$ ¹⁾	$\pm 10 \mu\text{m}$ ¹⁾²⁾	$\pm 2 \mu\text{m}$ ¹⁾	$\pm 10 \mu\text{m}$ ¹⁾²⁾
Repeatability 1 ²⁾	$\pm 0.5 \mu\text{m}$	$\pm 1 \mu\text{m}$	$\pm 0.5 \mu\text{m}$	$\pm 1 \mu\text{m}$	$\pm 0.5 \mu\text{m}$	$\pm 1 \mu\text{m}$
Measuring range 2	100 ... 400 mm		100 ... 400 mm		100 ... 400 mm	
Resolution 2	2 μm		2 μm		2 μm	
Accuracy 2 ¹⁾	$\pm 20 \mu\text{m}$		$\pm 20 \mu\text{m}$		$\pm 20 \mu\text{m}$	
Repeatability 2 ¹⁾	$\pm 0.5 \mu\text{m}$		$\pm 0.5 \mu\text{m}$		$\pm 0.5 \mu\text{m}$	
Material temperature ²⁾	up to 40 °C					

¹⁾ 2 σ

²⁾ without additional cooling

Advantages:

- Measurement of geometrical parameters (inner and total thickness of checkered plate)
- Large offset distance related to the measuring range
- Robust design for harsh environments based on proven protection concepts

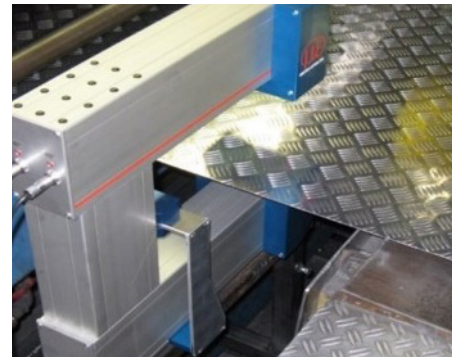
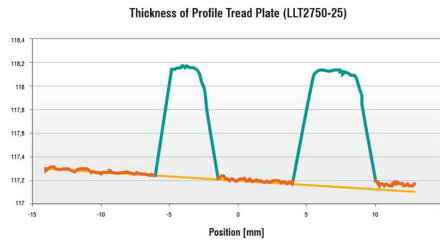

Applications with sensor technology from Micro-Epsilon

Measurement of profile characteristics

The high information density of the discrete laser line can be used to achieve improved robustness of the system and measurement of profile information.

This technology is currently the only system that can accurately measure the internal and total thickness of checker or button plate during production.

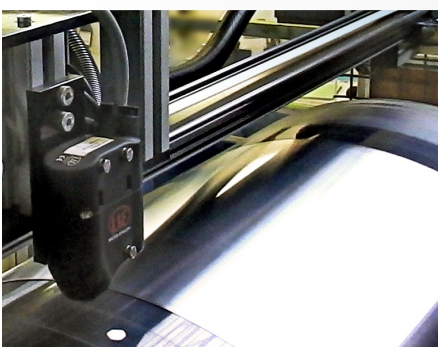
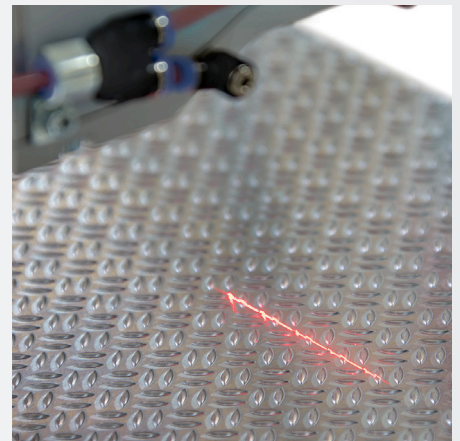
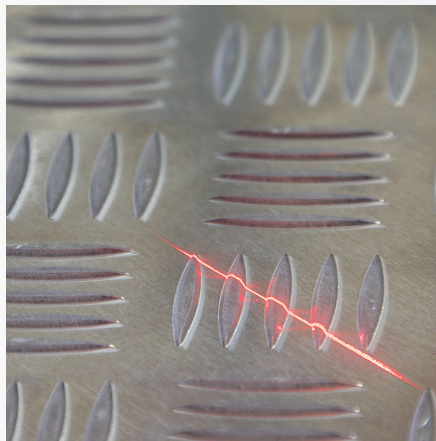

Applications with sensor technology from Micro-Epsilon

Measurement of zinc strip or paint color with colorCONTROL ACS 7000 and ACS 1

Advantages:

- Accuracy and high speed for inline integration
- 100% quality control
- Reduces waste





Processing lines / Service Centers

thicknessCONTROL MTS 8201.LLT

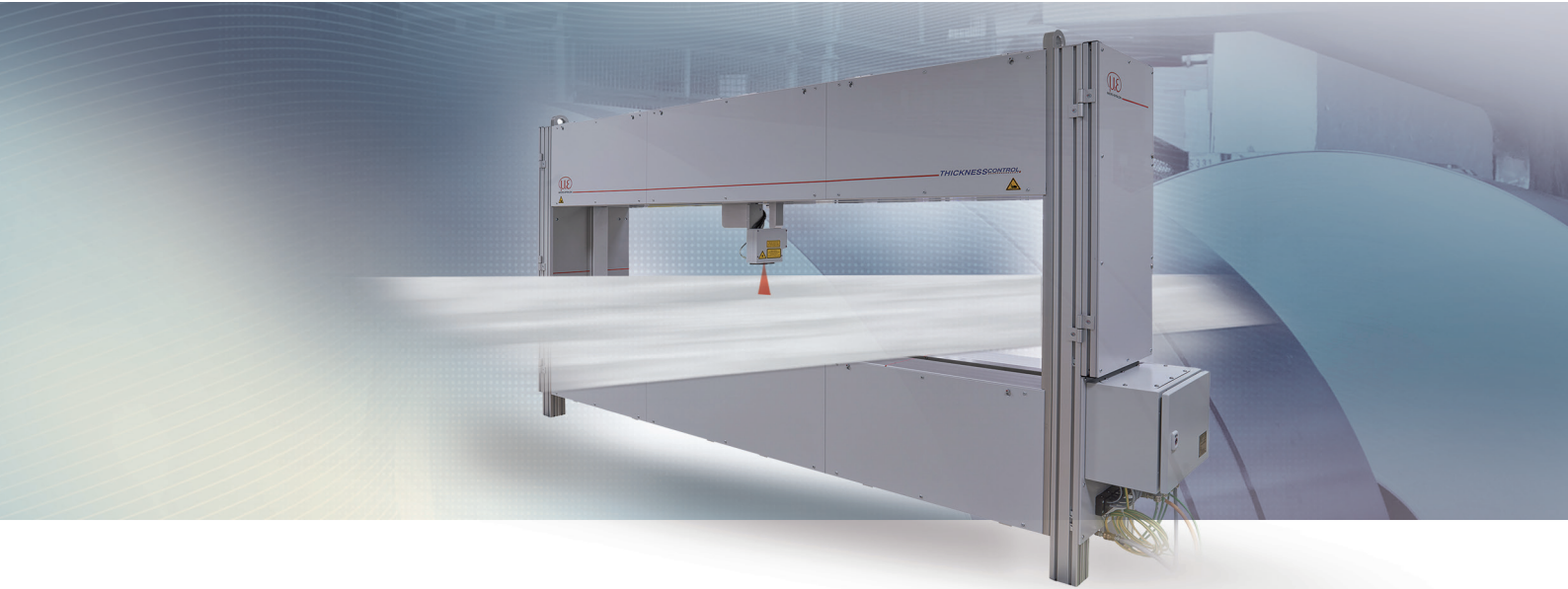

thicknessCONTROL MTS 8201.LLT

In process lines such as painting lines, thickness gauges are used in many places. This ensures both high product and efficiency requirements.

The thicknessCONTROL MTS 8201.LL system is ideally suited for large widths and the detection of cross profiles by fast traversing due to its O-frame design. The traversing speed can be increased to 64 m/min as an option. In order to compensate for the significant temperature influences on the mechanics at large widths, a patented temperature compensation is integrated. The machine includes a special, thermally-stable frame as reference. With additional sensor technology, the changes of the measurement frame caused by temperature fluctuations are measured and compensated for using special algorithms.

Compact and highly dynamic

In cutting lines such as slitting shears and cut-to-length shears, a thickness measurement is used as final quality control or incoming goods inspection. This ensures the tolerance of the material to be supplied. The system is particularly suitable for slitting lines. The high lateral resolution of the laser line enables high precision thickness measurements of each strip up to the edge. This is how every coil produced, even with very small widths, can be evaluated and documented. The large operating range of the thicknessCONTROL MTS 8201.LLT combined with high precision is important just after the cutter spindle, as the cutting process initiates vertical movements. Laser point sensors would not be able to provide the high precision at the measuring ranges required here.

Extendable to up to 5 measuring tracks

For typical applications in shearing lines, where three tracks along the sheet are measured, as well as width and length of the sheet, thicknessCONTROL MTS 8201.LLT can be extended to up to five measuring units. These can be moved independently of each other.

Advantages:

- Patented compensation of parasitic, thermal effects
- Up to 64 m/min traversing speed for large widths
- Detection and compensation of tilt
- Thickness measurement up to the edge due to high lateral resolution

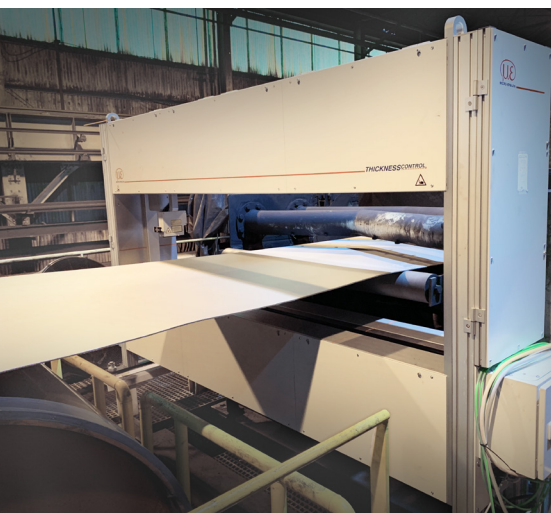

thicknessCONTROL MTS 8201.LLT

Applications

Measurement quantities and possible positioning for systems and sensors from Micro-Epsilon in painting lines

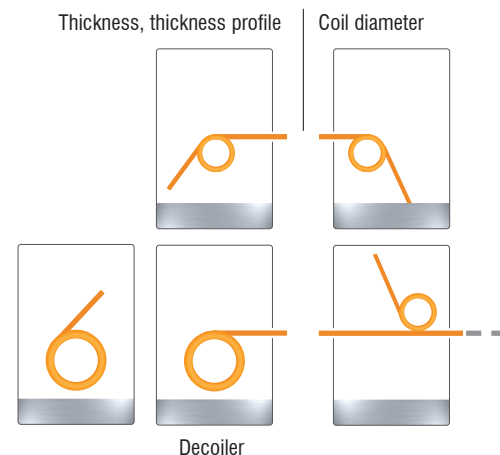

thicknessCONTROL MTS 8201.LLT-60						
Article no.	4350006.10	4350006.12	4350006.14	4350006.16	4350006.32	4350006.33
Measuring width	500 mm	1000 mm	1500 mm	2000 mm	2500 mm	3000 mm
Measuring range	60 mm					
Resolution	0.2 μm					
Accuracy ¹⁾	$\pm 2 \mu\text{m}$					
Repeatability ¹⁾	$\pm 0.5 \mu\text{m}$					
Material temperature ²⁾	up to 40 °C					

thicknessCONTROL MTS 8201.LLT-400						
Article no.	4350006.11	4350006.13	4350006.15	4350006.34	4350006.35	4350006.36
Measuring width	500 mm	1000 mm	1500 mm	2000 mm	2500 mm	3000 mm
Measuring range 1	100 mm					
Resolution 1	0.5 μm					
Accuracy 1 ^{1) 2)}	$\pm 10 \mu\text{m}$					
Repeatability 1 ¹⁾	$\pm 1 \mu\text{m}$					
Measuring range 2	100 ... 400 mm					
Resolution 2	2 μm					
Accuracy 2 ¹⁾	$\pm 20 \mu\text{m}$					
Repeatability 2 ¹⁾	$\pm 5 \mu\text{m}$					
Material temperature ²⁾	up to 40 °C					

¹⁾ 2 σ

²⁾ without additional cooling



Applications with sensor technology from Micro-Epsilon

Measuring the coil diameter during winding with optoNCDT ILR 2250 time-of-flight sensors

Advantages:

- Automated inline monitoring of the coil
- Wear-free and non-contact measurement
- Direct and precise diameter detection
- No tracking of the sensor necessary
- Changeover time of the coil can be planned early
- Reduces the changeover time



Applications

Measurement quantities and possible positioning for systems and sensors from Micro-Epsilon in painting lines

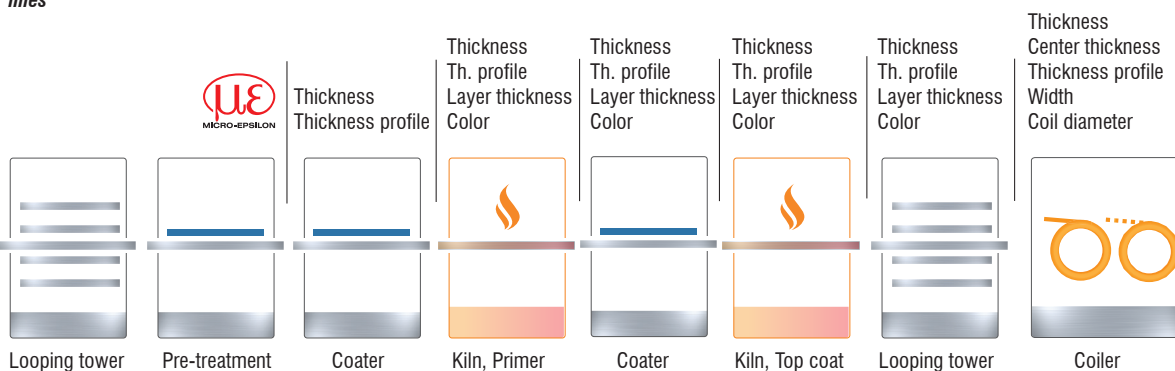

Your local support

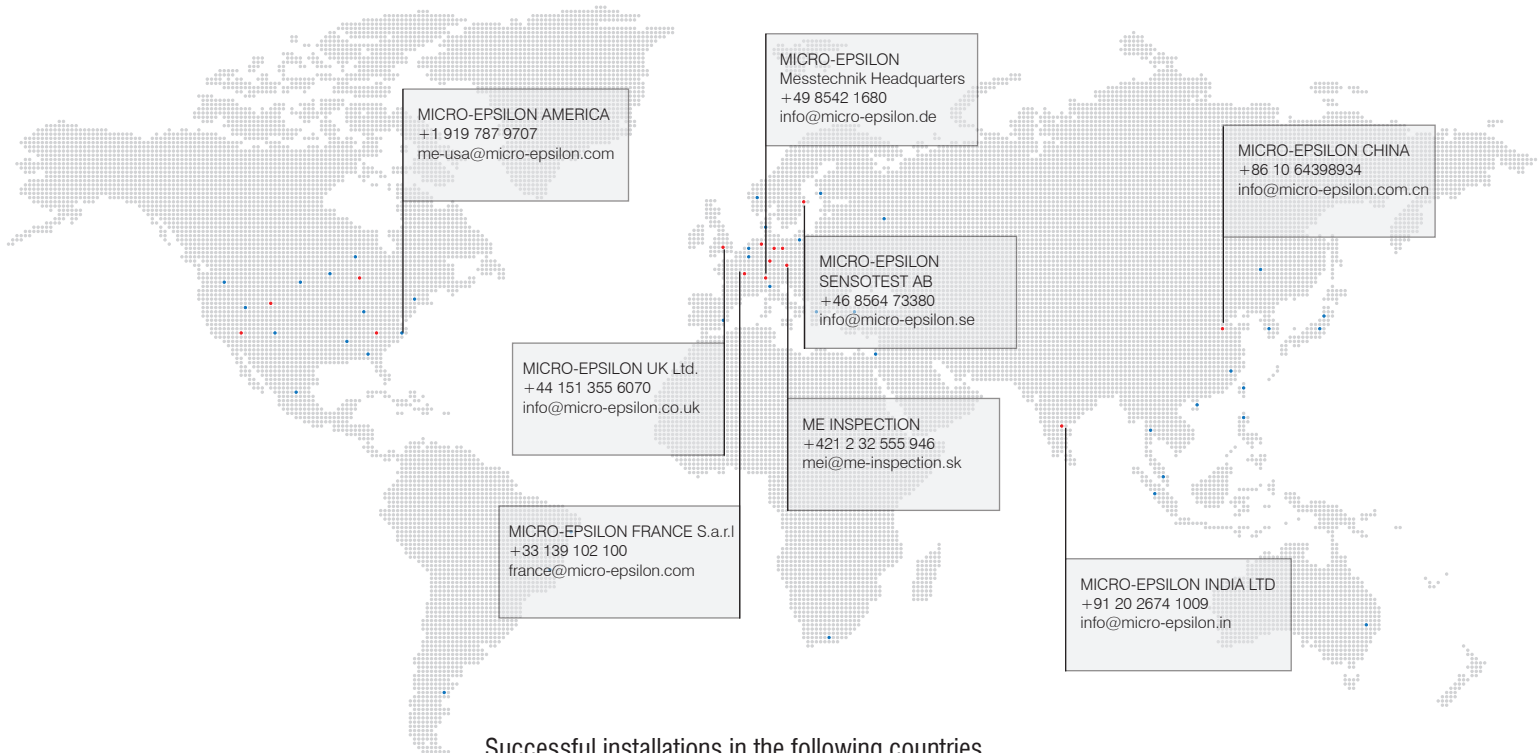

Successful installations in the following countries



MICRO-EPSILON

More precision for added value

Performance and quality, as well as reliability of products and services have made Micro-Epsilon Messtechnik GmbH & Co. KG one of the leading suppliers of inspection systems for optical thickness measurement used in the metal industry. Numerous, successful installations in 13 countries around the world in milling lines and processing lines speak for themselves. Developing and producing all the necessary core components such as sensors, software and measurement-specific machine building inside the company group provides unique innovative skills that are mirrored in the product portfolio of Micro-Epsilon.

MICRO-EPSILON Headquarters
Koenigbacher Str. 15 · 94496 Ortenburg / Germany
Tel. +49 (0) 8542 / 168-0 · Fax +49 (0) 8542 / 168-90
info@micro-epsilon.com · www.micro-epsilon.com