



**SCIGATE AUTOMATION (S) PTE LTD**

Bukit Batok Street 22 #01-01 Singapore 659592

Tel: (65) 6561 0488

Fax: (65) 6561 0588

Email: [sales@scigate.com.sg](mailto:sales@scigate.com.sg)

Web: <https://scigate.com.sg/>







Business Hours: Monday - Friday 8:30AM - 6:15PM

# More Precision

**eddyNCDT 3070** // High-performance inductive displacement measuring system





-  **Wide range of applications with numerous sensor models**
-  **High temperature stability**
-  **High resolution & linearity**
-  **Frequency response 20 kHz (-3dB)**
-  **Sensors for ferromagnetic and non-ferromagnetic targets**
-  **Analog output (U/I)  
Digital output**
-  **Intuitive configuration via web interface**

#### High performance for the industry

The eddyNCDT 3070 is a powerful, inductive sensor system based on eddy currents for measuring ranges smaller than 1 mm. The system comprises a compact controller, a sensor and an integrated cable and is factory-calibrated either for ferromagnetic or non-ferromagnetic materials.

#### Integration into plant and machinery

As sensor and controller are temperature-compensated, a high measurement accuracy can be achieved even in fluctuating temperatures. The sensors are designed for ambient temperatures up to a maximum of +200 °C and an ambient pressure up to 700 bar. The compact controller design as well as the sensor robustness make the measuring system ideal for integration into plant and machinery.

#### New benchmark in controller technology

The industrial-grade M12 Ethernet interface offers a modern fieldbus connection. Configurable analog outputs enable to output the measured values as voltage or current. For multi-system operation, the systems come with a new kind of frequency separation (LF/HF) which enables to operate several sensors next to one another without requiring any synchronization.

Features	Controller type	
	DT3070	DT3071
Active temperature compensation for sensor and controller	✓	✓
Frequency separation (LF & HF)	✓	✓
Industrial Ethernet interface	✓	✓
Intuitive web interface	✓	✓
Multipoint calibration regardless of the distance (up to 3-point calibration)	✓	✓
Scalable measuring range via analog output (teach function)	✓	✓
Scalable analog output	✓	✓
Switching and temperature outputs	-	✓
5-point calibration	-	✓
Storage of multiple characteristic curves	-	✓



When connecting a PC via the Ethernet interface, a modern web interface can be accessed without any further installation and enables the parameterization of sensor and controller. The DT3071 controller provides enhanced features such as 5-point calibration, setting of switching and temperature outputs, as well as storage of multiple characteristic curves.

Model	DT3070	DT3071
Resolution <sup>1)</sup>	static (20 Hz)	0.005 % FSO
	dynamic (20 kHz)	0.025 % FSO
Frequency response (-3dB)	selectable (20 kHz, 5 kHz, 20 Hz)	
Measuring rate	50 kSa/s	
Linearity <sup>2)</sup>	< ± 0.2 % FSO	< ± 0.1 % FSO
Temperature stability	< 0.05 % FSO / K	
Temperature compensation	+10 ... +50 °C	
Synchronization	with LF & HF variants	
Target material <sup>3)</sup>	Steel, aluminum	
No. of characteristic curves	1	max. 4
Supply voltage	12 ... 32 VDC	
Power consumption	2.5 W	
Digital interface	Industrial Ethernet	
Analog output	0 ... 10 V; 4 ... 20 mA (short circuit proof)	
Connection	Sensor: plug connector triaxial socket; supply/signal: 8-pole M12 connector; Industrial Ethernet: 5-pole M12 connector (cable see accessories)	
Mounting	through bores	
Temperature range	Storage	-10 ... +70 °C
	Operation	0 ... +50 °C
Shock (DIN-EN 60068-2-29)	15 g / 6 ms in 3 axes, 2 directions and 1000 shocks each	
Vibration (DIN-EN 60068-2-6)	5 g / 10 ... 500 Hz in 3 axes, 2 directions and 10 cycles each	
Protection class (DIN-EN 60529)	IP67 (plugged)	
Material	Die-cast aluminum	
Weight <sup>3)</sup>	approx. 230 g	

FSO = Full Scale Output

<sup>1)</sup> RMS noise relates to mid of measuring range

<sup>2)</sup> Value with 3-point linearization (DT3070) or 5-point linearization (DT3071)

<sup>3)</sup> Steel: St37 steel DIN1.0037 / aluminum: AlCuMgPb3.1645

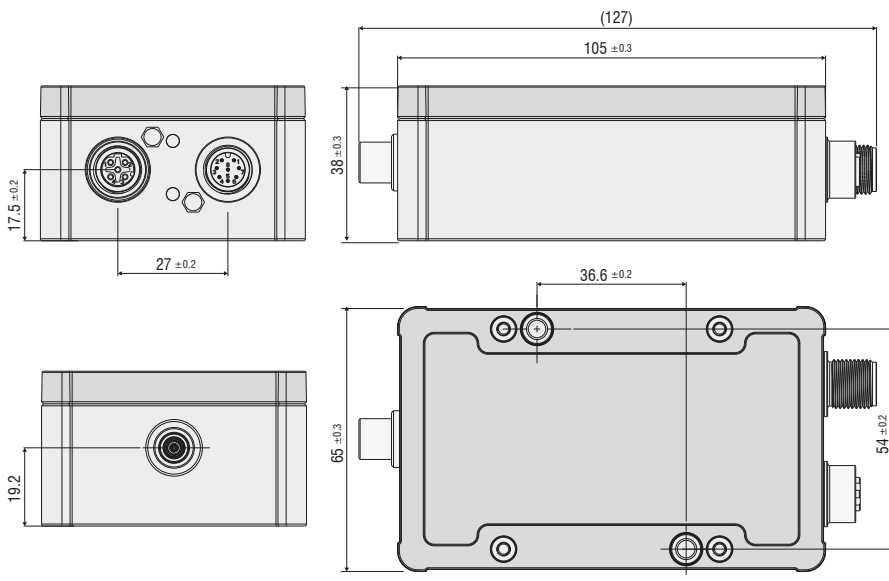

#### Pin assignment IN/OUT/24V IN

Pin	Assignment	Color (cable: PCx/8-M12)
1	Analog output U <sub>Displacement</sub>	White
2	Supply +24 V	Brown
3	Limit value 1 / U <sub>Temp sensor</sub>	Green
4	Limit value 2 / U <sub>Temp controller</sub>	Yellow
5	GND Temperature, limit value	Gray
6	GND analog output	Pink
7	GND supply	Blue
8	Analog output I <sub>Displacement</sub>	Red



8-pole M12x1 housing connector  
View on pin side

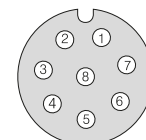

Dimensions in mm, not to scale.

## Sensors and Systems from Micro-Epsilon



Sensors and systems for displacement, distance and position



Sensors and measurement devices for non-contact temperature measurement



Measuring and inspection systems for metal strips, plastics and rubber



Optical micrometers and fiber optics, measuring and test amplifiers



Color recognition sensors, LED analyzers and inline color spectrometers

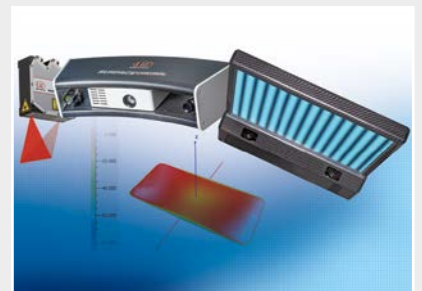

3D measurement technology for dimensional testing and surface inspection