



SCIGATE AUTOMATION (S) PTE LTD

Bukit Batok Street 22 #01-01 Singapore 659592

Tel: (65) 6561 0488

Fax: (65) 6561 0588

Email: sales@scigate.com.sg

Web: <https://scigate.com.sg/>

Business Hours: Monday - Friday 8:30AM - 6:15PM

More Precision

optoNCDT // Laser displacement sensors (triangulation)





- **Ideal for serial and OEM applications**
- ⊕ **Compact design with integrated controller**
- 🎯 **Measuring rate up to 1 kHz**
- 🔌 **INTER FACE Analog output (I) / RS422**
- ⏸ **Plug & Play via select button**
- 🛡 **ASC Active Surface Compensation**

The optoNCDT 1220 is a laser triangulation sensor with compact size for precise displacement, distance and position measurements. The laser sensor is available with measuring ranges from 10 to 50 mm and offers both high measurement accuracy and an adjustable measuring rate up to 1 kHz.

Due to its extremely compact size with integrated controller, the sensor can also be installed in restricted spaces. As well as an analog output, an RS422 interface is available for integration. Its low weight makes this laser sensor ideally suitable for applications where high accelerations occur, e.g., in industrial printers or on robot grippers.

The Active Surface Compensation (ASC) provides stable distance signal control regardless of target color or brightness. Commissioning is quick and easy via function keys or the web interface.

The optoNCDT 1220 offers a unique combination of design, versatility and measurement accuracy. Due to its excellent price/performance ratio, the sensor is ideal for automation tasks and OEM integration with a large number of pieces.

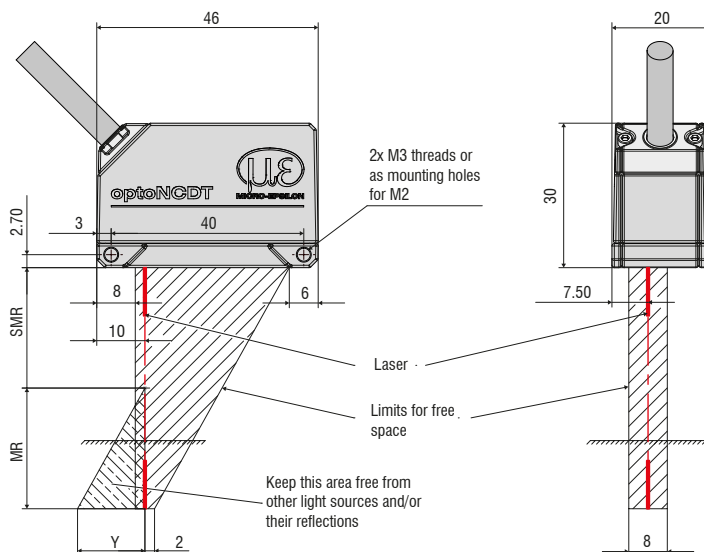

MR	SMR	Y
10	20	10
25	25	21
50	35	28

Model	ILD1220-10	ILD1220-25	ILD1220-50
Measuring range	10 mm	25 mm	50 mm
Start of measuring range	20 mm	25 mm	35 mm
Mid of measuring range	25 mm	37.5 mm	60 mm
End of measuring range	30 mm	50 mm	85 mm
Measuring rate ¹⁾	3 adjustable stages: 1 kHz / 0.5 kHz / 0.25 kHz		
Linearity	< ±10 μm	< ±25 μm	< ±50 μm
	< ±0.10 % FSO		
Repeatability ²⁾	1 μm	2.5 μm	5 μm
Temperature stability	±0.015 % FSO / K		
Light spot diameter (±10 %)	SMR	90 x 120 μm	100 x 140 μm
	MMR	45 x 40 μm	120 x 130 μm
	EMR	140 x 160 μm	390 x 500 μm
	smallest diameter	45 x 40 μm with 24 mm	55 x 50 μm with 31 mm
Light source	Semiconductor laser < 1 mW, 670 nm (red)		
Laser safety class	Class 2 in accordance with DIN EN 60825-1: 2015-07		
Permissible ambient light ³⁾	20,000 lx		
Supply voltage	11 ... 30 VDC		
Power consumption	< 2 W (24 V)		
Digital interface	RS422 (16 bit)		
Analog output	4 ... 20 mA (12 bit, freely scalable within the measuring range) ⁴⁾		
Switching output	1 x error output: npn, pnp, push pull		
Connection	integrated cable 2 m, open ends, minimum bending radius 30 mm (fixed installation)		
Installation	Screw connection via two mounting holes		
Temperature range	Storage	-20 ... +70 °C (non-condensing)	
	Operation	0 ... +50 °C (non-condensing)	
Shock (DIN EN 60068-2-29)	15 g / 6 ms in 3 axes, 1000 shocks each		
Vibration (DIN EN 60068-2-6)	20 g / 20 ... 500 Hz in 3 axes, 2 directions and 10 cycles each		
Protection class (DIN EN 60529)	IP65		
Material	Aluminum housing		
Weight	approx. 30 g (without cable), approx. 110 g (incl. cable)		
Control and display elements	Select button: zero / teach / factory settings; web interface for setup ⁵⁾ ; 2 x color LEDs for power / status		

FSO = Full Scale Output

SMR = Start of measuring range, MMR = Mid of measuring range, EMR = End of measuring range

The specified data apply to white, diffuse reflecting surfaces (Micro-Epsilon reference ceramic for ILD sensors)

¹⁾ Factory setting 1 kHz, modifying the factory setting requires the IF2001/USB converter (see accessories)

²⁾ Measuring rate 1 kHz, median 9

³⁾ Illuminant: light bulb

⁴⁾ The D/A conversion is executed at 12 bits

⁵⁾ Connection to PC via IF2001/USB (see accessories)

Accessories for all optoNCDT series (except for LD16x0)

Power supply

- PS 2020 (power supply 24 V / 2.5 A, input 100 - 240 VAC, output 24 VDC / 2.5 A, mounting onto symmetrical standard rail 35 mm x 7.5 mm, DIN 50022)

Controller unit for evaluation and signal conversion

- C-Box/2A (controller for conversion and evaluation of up to 2 sensor signals)

Interface card

- IF2008PCI / IF2008PCIe (interface card for multiple signal processing; analog and digital interfaces)

USB converter

- IF2001/USB RS422/USB converter (converter for digital signals in USB)
- IF2004/USB 4-channel RS422/USB converter (converter for up to 4 digital signals in USB)

Interface module for Industrial Ethernet connection

- IF2030/PNET
- IF2030/ENETIP

Accessories optoNCDT 1420/1402CL1

Supply and output cable (drag-chain suitable)

- PCF1420-1/I (1 m, output 4 ... 20 mA)
- PCF1420-1/I(01) (1 m, output 4...20 mA)
- PCF1420-3/I (3 m, output 4 ... 20 mA)
- PCF1420-6/I (6 m, output 4 ... 20 mA)
- PCF1420-10/I (10 m, output 4 ... 20 mA)
- PCF1420-15/I (15 m, output 4 ... 20 mA)
- PCF1420-3/U (3 m, with integrated resistor, output 1 ... 5 VDC)*
- PCF1420-6/U (6 m, with integrated resistor, output 1 ... 5 VDC)*
- PCF1420-10/U (10 m, with integrated resistor, output 1 ... 5 VDC)*
- PCF1420-15/U (15 m, with integrated resistor, output 1 ... 5 VDC)*
- PCF1420-3/IF2008 (3 m, interface and supply cable)
- PCF1420-6/IF2008 (6 m, interface and supply cable)
- PCF1420-10/IF2008 (10 m, interface and supply cable)
- PCF1420-3/C-Box (3 m)

* on request with output 2 ... 10 VDC

Supply and output cable, suitable for use with robots

(available in 90° version)

- PCR1402-3/I (3 m)
- PCR1402-6/I (6 m)
- PCR1402-8/I (8 m)

Accessories for optoNCDT 1610/1630

Supply and output cable

- PC1605-3 (3 m)
- PC1605-6 (6 m)
- PC1607-5/BNC (5 m, BNC connector)

Accessories for optoNCDT 1750BL / 1750DR / 1710 / 1710BL

Supply and output cable (drag-chain suitable)

- PC1700-3 (3 m)
- PC1700-10 (10 m)
- PC1700-10/IF2008 (10 m, for use with interface card IF2008)
- PC1750-3/C-Box (3 m)
- PC1750-6/C-Box (6 m)
- PC1750-9/C-Box (9 m)

Supply and output cable (suitable for use with robots)

- PCR1700-5 (5 m)
- PCR1700-10 (10 m)

Supply and output cables for temperatures up to 200 °C

- PC1700-3/OE/HT (3 m)
- PC1700-6/OE/HT (6 m)
- PC1700-15/OE/HT (15 m)

Protection housing

- SGH model (sizes S and M)
- SGHF model (sizes S and M)
- SGHF-HT model

Accessories for optoNCDT 2300/2300LL/2300BL/2300-2DR

Supply and output cable

- PC2300-0,5Y (connection cable to PC or PLC; for operation a PC2300-3/SUB-D will be required)
- PC2300-3/SUB-D (3 m; for operation a PC2300-0,5Y will be required)
- PC2300-3/IF2008 (interface and supply cable)
- PC2300-3/OE (3 m)
- PC2300-6/OE (6 m)
- PC2300-9/OE (9 m)
- PC2300-15/OE (15 m)
- PC2300-3/C-Box/RJ45 (3 m)

* other cable lengths on request

Protection housing

- SGH model (sizes S and M)
- SGHF model (sizes S and M)
- SGHF-HT model

Supply and output cables for temperatures up to 200 °C

- PC2300-3/OE/HT (3 m)
- PC2300-6/OE/HT (6 m)
- PC2300-9/OE/HT (9 m)
- PC2300-15/OE/HT (15 m)

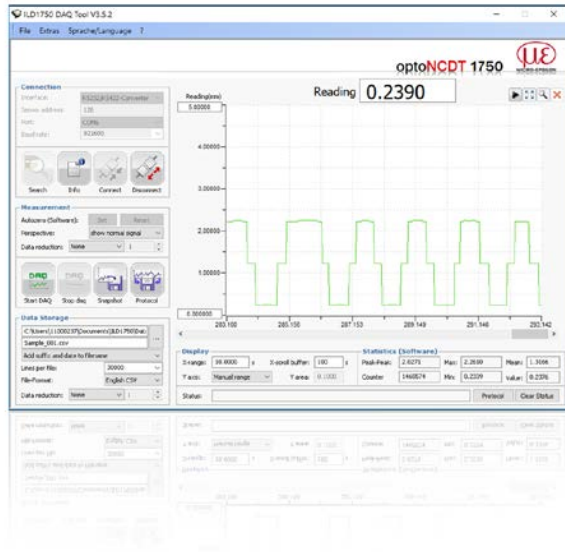

optoNCDT Demo Tool

The scope of supply includes a software for easy sensor configuration. The settings can be implemented conveniently via a Windows user interface on the PC. The sensor parameters are transmitted to the sensor via the serial port and can also be saved if required. The software is available as single and multi-channel version. The sensor is connected to the PC via the sensor cable using a USB converter. [for any ILD sensor]

Free download

Download free of charge from www.micro-epsilon.com/download: software, driver and well-documented driver DLL for easy sensor integration in existing or customer software.

Protection housing for demanding environments

To protect the optoNCDT laser sensors in harsh environments, protective housings are available in different designs.

SGH model

Completely enclosed housing with an integrated front window, where the sensor measures through the window. The water-resistant housing provides protection against solvents and detergents.

SGHF model

With window and compressed-air connection ideal for high ambient temperatures. The integrated air cooling of the housing offers optimum protection for the sensor.

SGHF-HT model

This water-cooled protection housing with window and compressed-air connection is designed for measurement tasks in ambient temperatures up to 200 °C.

Suitable for all long-range sensors

optoNCDT 1710

optoNCDT 1750-500 and optoNCDT 1750-750

optoNCDT 2310

optoNCDT 2300 - 200

Maximum ambient temperature 200 °C

Maximum temperature of cooling water $T(\text{max}) = 10\text{ °C}$

Minimum water flow rate $Q(\text{min}) = 3\text{ liters/min}$



SGHx ILD size S (140x140x71 mm)
for optoNCDT 1750 / 2300 dimensions 97x75 mm



SGHx ILD size M (140x180x71 mm)
for optoNCDT 1750 / 2300 dimensions 150x80 mm

IF2008PCI/IF2008PCIe - PCI Interface card for synchronous data acquisition

The absolutely synchronous data acquisition is a decisive factor for the planarity or thickness measurement using several laser sensors. The IF2008PCI interface card is designed for installation in PCs and enables the synchronous capture of four digital sensor signals and two encoders. The data are stored in a FIFO memory in order to enable resource-saving processing in blocks in the PC. The IF2008E expansion board enables to detect in addition two digital sensor signals, two analog sensor signals and eight I/O signals.

Special features

- IF2008 basic printed circuit board: 4 digital signals and 2 encoders
- IF2008E - Expansion board: 2x digital signals, 2x analog signals and 8x I/O signals

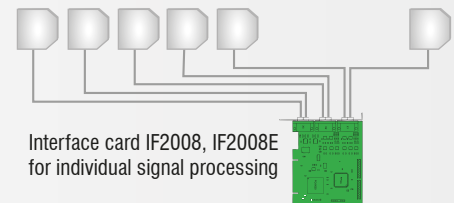
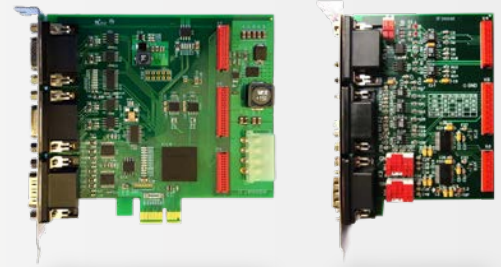

IF2001/USB converter RS422 to USB

The RS422/USB converter transforms digital signals from a laser-optical sensor into a USB data packet. The sensor and the converter are connected via the RS422 interface of the converter. Data output is done via USB interface. The converter loops through further signals and functions such as laser on/off, switch signals and function output. The connected sensors and the converter can be programmed through software.

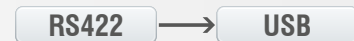
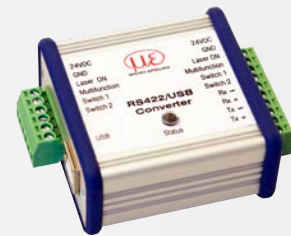

IF2004/USB: 4-channel converter from RS422 to USB

The RS422/USB converter is used for transforming digital signals from up to four optical sensors into USB data signals. The converter has four trigger inputs and a trigger output for connecting additional converters. Data is output via an USB interface. The connected sensors and the converter can be programmed through software.

Special features

- 4x digital signals via RS422
- 4x trigger inputs, 1x trigger output
- Synchronous data acquisition
- Data output via USB

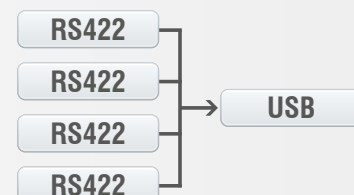

C-Box/2A Controller for D/A conversion and evaluation

C-Box/2A is used for fast D/A conversion of two digital input signals or for evaluating two digital sensor signals. The controller is compatible with the optoNCDT 1420, 1750 und 2300 models. Handling of the C-Box/2A and of the connected sensors are performed via web interface. Averaging functions, thickness, diameter, step and inclinations can be calculated. The D/A conversion is executed at 16 bit and max. 70 kHz.



Special features

- Trigger input
- Multi-function output
- Measurement value output via Ethernet, USB, analog output
4 ... 20 mA / 0 ... 5 V / 0 ... 10 V / ± 5 V / ± 10 V
(scalable via web interface)
- 2x switching outputs for sensors or C-Box/2A status
- Parallel data output via 3 output interfaces

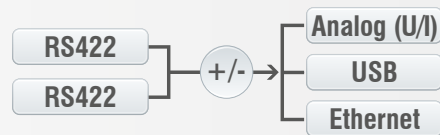

IF2030

Interface module for Industrial Ethernet connection

The IF2030 interface modules are designed for easy connection of Micro-Epsilon sensors to Ethernet-based fieldbuses, e.g., plant control systems. The PROFINET and Ethernet/IP modules are compatible with sensors that output data via an RS422 or RS485 interface. These modules operate on the sensor side with up to 4 MBd and have two network connections for different network topologies. Installation in switching cabinets is via a DIN rail.



EtherNet/IP

PROFINET

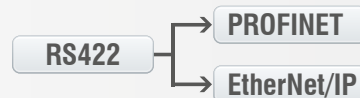

Sensors and Systems from Micro-Epsilon



Sensors and systems for displacement, distance and position



Sensors and measurement devices for non-contact temperature measurement



Measuring and inspection systems for metal strips, plastics and rubber



Optical micrometers and fiber optics, measuring and test amplifiers



Color recognition sensors, LED analyzers and inline color spectrometers

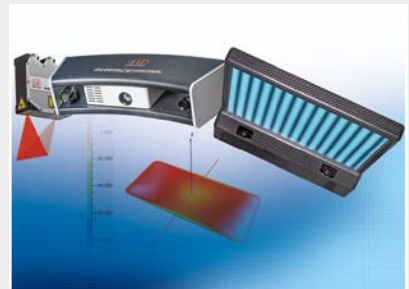

3D measurement technology for dimensional testing and surface inspection