



**SCIGATE AUTOMATION (S) PTE LTD**

No.1 Bukit Batok Street 22 #01-01 Singapore 659592

Tel: (65) 6561 0488

Fax: (65) 6562 0588

Email: sales@scigate.com.sg

Web: www.scigate.com.sg

Business Hours: Monday - Friday 8.30am - 6.15pm



Operating Instructions  
opto**NCDT** 5500

ILD5500-10 ILD5500-100  
ILD5500-25 ILD5500-200

Intelligent laser-optical displacement measurement

MICRO-EPSILON MESSTECHNIK  
GmbH & Co. KG  
Königbacher Str. 15

94496 Ortenburg / Germany

Tel: +49 (0) 8542 / 168-0

Fax: +49 (0) 8542 / 168-90

E-Mail: [info@micro-epsilon.com](mailto:info@micro-epsilon.com)

[www.micro-epsilon.com/contact/worldwide/](http://www.micro-epsilon.com/contact/worldwide/)

<https://www.micro-epsilon.com>

## Contents





1	Safety.....	4
1.1	Symbols used.....	4
1.2	Warnings.....	4
1.3	Notes on product marking.....	5
1.3.1	CE marking.....	5
1.3.2	UKCA marking.....	5
1.4	Intended use.....	5
1.5	Proper environment.....	5
2	Laser Safety.....	6
3	Functional principle, technical data.....	7
3.1	Brief description.....	7
3.2	Advanced Surface Compensation.....	7
3.3	Technical data ILD5500 General.....	8
3.4	Technical data Measuring range 10/25/100/200.....	8
3.5	Control and indicator elements.....	9
4	Delivery.....	10
4.1	Delivery.....	10
4.2	Storage.....	10
5	Installation.....	11
5.1	Notes on operation.....	11
5.1.1	Reflectance of target surface.....	11
5.1.2	Optimization of measurement accuracy.....	11
5.2	Mechanical fastening.....	12
5.2.1	General.....	12
5.2.2	Mounting, dimensional drawing ILD5500.....	13
5.3	Electrical connections.....	15
5.3.1	Connection options.....	15
5.3.2	Pin assignment.....	15
5.3.3	Supply voltage.....	16
5.3.4	Turning on the Laser.....	17
5.3.5	Connector and Sensor Cable.....	17
6	Operation.....	18
6.1	Operation via web interface.....	18
6.1.1	Requirements.....	18
6.1.2	Access via web interface.....	19
6.2	Presets, Setups, selection of measurement configuration.....	20
6.3	Display of measurement values in the web browser.....	21
6.4	Video signal display in the web browser.....	22
6.5	Parameterization via ASCII commands.....	24
6.6	Timing, measurement value cycles.....	24
7	Digital interface RS422.....	25
7.1	Preliminary remarks.....	25
7.2	Measurement data format.....	25
7.3	Conversion of the binary data format.....	25
8	Digital output values.....	26
8.1	RS422.....	26
8.2	Ethernet.....	26
9	Cleaning.....	28
10	Service, repair.....	29
11	Decommissioning, disposal.....	30
12	Disclaimer.....	31
13	Optional accessories.....	32
	Index.....	33

# 1 Safety

## 1.1 Symbols used

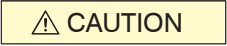
System operation assumes knowledge of the operating instructions.

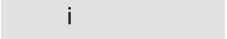
The following symbols are used in these operating instructions:



 CAUTION	Indicates a situation which, if not avoided, may result in minor or moderate injury.
 NOTICE	Indicates a situation that may result in property damage if not avoided.
	Indicates a user action.
	Indicates a tip for users.
	Indicates hardware or a software button/menu.

## 1.2 Warnings

Do not expose yourself to unnecessary laser radiation.

- ▶ Switch off the sensor for cleaning and maintenance.
- ▶ Switch off the sensor for cleaning and maintenance if the sensor is integrated into a system.

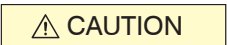
Caution - the use of controls or settings or the performance of procedures not specified in the operating instructions may cause damage.

 CAUTION	<p>Connect the power supply according to the regulations for electrical equipment.</p> <ul style="list-style-type: none"> <li>• Risk of injury</li> <li>• Damage to or destruction of the sensor</li> </ul>
 NOTICE	<p>Avoid knocks and impacts to the sensor.</p> <ul style="list-style-type: none"> <li>• Damage to or destruction of the sensor</li> </ul> <p>Only attach the sensor to the existing mounting holes/threaded holes on a flat surface; clamping of any kind is not permitted.</p> <ul style="list-style-type: none"> <li>• Damage to or destruction of the sensor</li> </ul> <p>The supply voltage must not exceed the specified limits.</p> <ul style="list-style-type: none"> <li>• Damage to or destruction of the sensor</li> </ul> <p>Protect the sensor cable from damage. Attach the cable load-free, catch the cable after approx. 25 cm and catch the pigtail on the plug, e.g. with cable ties.</p> <ul style="list-style-type: none"> <li>• Destruction of the sensor</li> <li>• Failure of the measuring device</li> </ul> <p>Avoid constant exposure of light source and receiver to splashes of water.</p> <ul style="list-style-type: none"> <li>• Damage to or destruction of the sensor</li> </ul> <p>Avoid exposure of sensor to aggressive media (detergents, cooling emulsions).</p> <ul style="list-style-type: none"> <li>• Damage to or destruction of the sensor</li> </ul>

## 1.3 Notes on product marking

### 1.3.1 CE marking

The following apply to the product:

- Directive 2014/30/EU ("EMC")
- Directive 2011/65/EU ("RoHS")

Products which carry the CE marking satisfy the requirements of the EU Directives cited and the relevant applicable harmonized European standards (EN).

The product is designed for use in industrial and laboratory environments.

The EU Declaration of Conformity and the technical documentation are available to the responsible authorities according to the EU Directives.

### 1.3.2 UKCA marking

The following apply to the product:

- SI 2016 No. 1091 ("EMC")
- SI 2012 No. 3032 („RoHS")

Products which carry the UKCA marking satisfy the requirements of the directives cited and the relevant applicable harmonized standards.

The product is designed for use in industrial and laboratory environments.

The UKCA Declaration of Conformity and the technical documentation are available to the responsible authorities according to the UKCA Directives.

## 1.4 Intended use

The sensor is designed for use in industrial and laboratory environments.

It is used for

- Measuring distance, position, geometry, and thickness
- Monitoring Quality and Checking Dimensions

The sensor must only be operated within the values specified in the technical data., [see Chap. 3.3](#)

The sensor must be used in such a way that no persons are endangered and no machines or other physical items of property are damaged in the event of malfunction or total failure of the sensor.

Take additional precautions for safety and damage prevention in case of safety-related applications.

## 1.5 Proper environment

Protection class: IP67

i The protection class is limited to water (no penetrating liquids, detergents, or similar aggressive media).

Optical windows are excluded from the protection class. Contamination of the windows causes impairment or failure of the function.

Temperature range:

- Operation:	0 ... +50 °C
- Storage:	-20 ... +70 °C
Humidity:	5 ... 95% RH (non-condensing)
Ambient pressure:	Atmospheric pressure

## 2 Laser Safety

The sensor works with a semiconductor laser with a wavelength of 670 nm (visible/red).

The sensors fall within laser class 2. The laser is operated in pulsed mode, the maximum optical power is  $\leq 1$  mW. The pulse frequency depends on the set measuring rate (0.25 ... 75 kHz). The pulse duration of the peaks is regulated depending on the measuring rate and the reflectivity of the measuring object and can be 0.5 ... 3994.5  $\mu$ s.

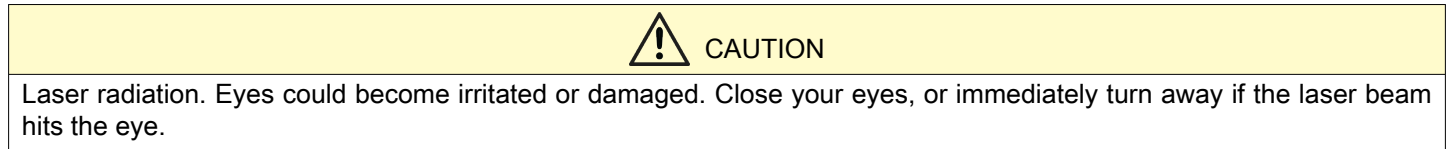

Relevant regulations must be observed when operating the sensors. The following apply accordingly:

- With class 2 laser devices, the eye is not endangered by random, brief exposure to laser radiation, i.e. exposure times of up to 0.25 s.
- Class 2 laser devices may therefore be used without further protective measures if you do not intentionally look into the laser beam or into specular-reflected radiation for more than 0.25 s.
- Because the presence of the eyelid protective reflex should not normally be assumed, one should deliberately close the eyes or turn away immediately if the laser beam hits the eye.

Lasers of Class 2 are not subject to notification and a laser protection officer is not required.

The following signs are attached to the sensor housing:

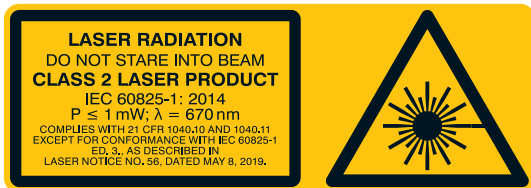

Fig. 2.1: Laser information and laser warning sign

- i If both information signs are covered when the unit is installed, the user must ensure that supplementary information signs are attached at the installation location.

Operation of the laser is indicated visually by the LED on the sensor.

The housing of the optical sensors may only be operated by the manufacturer, [see Chap. 12](#).

For repair and service purposes, the sensors must always be sent to the manufacturer.

Please observe national regulations, e. g., Laser Notice No. 56 for the USA.

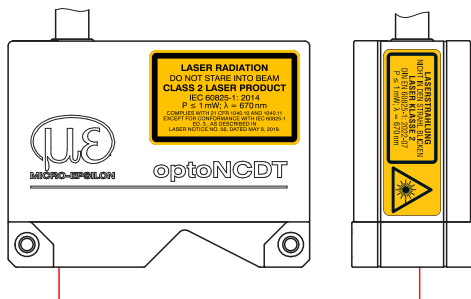

Fig. 2.2: Laser information and laser warning sign on the sensor housing

## 3 Functional principle, technical data

### 3.1 Brief description

The optoNCDT 5500 operates according to the principle of optical triangulation, i.e. a visible, modulated light spot is projected onto the surface of the measuring object.

The diffuse part of the reflection of this light spot is imaged on a spatial resolution element (CMOS) by a receiver optic arranged at a certain angle to the optical axis of the laser beam.

A signal processor in the sensor calculates the distances between the light spot on the target and the sensor from the output signal of the CMOS element. The distance value is linearized and output via the analog or RS422 interface.

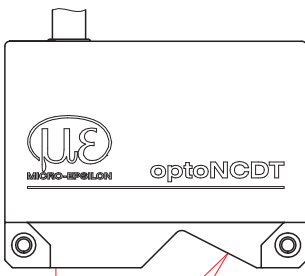

	Analog value		Digital value	
	Current	Voltage	RS422	Ethernet
e-SMR	3 mA	5.2 V / 10.2 V	262077	0x7FFFFFF05
SMR	4 mA (MBA)	0 V	98232	Millimeter
MMR	12 mA (MBM)	2.5 V / 5 V	131000	Millimeter
EMR	20 mA (MBE)	5 V / 10 V	163768	Millimeter
e-EMR			depends on measuring range	
	3 mA	5.2 V / 10.2 V	262078	0x7FFFFFF06

Fig. 3.1: Definition of terms

e-SMR	Reserve Start of measuring range
SMR	Start of measuring range
MMR	Mid of measuring range
EMR	End of measuring range
e-EMR	Reserve End of measuring range

The digital values apply to distance values without zeroing or mastering.

### 3.2 Advanced Surface Compensation

The sensor is equipped with intelligent surface control. New algorithms generate stable measurement results even on demanding surfaces where changing reflections occur. In addition, the new algorithms compensate for ambient light of up to 50,000 lux. The sensor therefore has the highest ambient light resistance in its class and can also be used in highly illuminated environments.

### 3.3 Technical data ILD5500 General

General technical data		ILD5500-x
Measuring rate <sup>[1]</sup>		0,25 kHz ... 75 kHz
Temperature stability <sup>[2]</sup>		±0.005 % FSO / K
Light source		Laser 670 nm
Laser class		Class 2 in accordance with IEC 60825-1: 2022-07
Supply voltage		12 ... 30 VDC
Power consumption		max. 5 W
Signal input		Laser on/off, sync in, trigger/MFI in
Digital interface <sup>[3]</sup>		RS422 (16 bit in the standard measuring range, 18 bit in the extended measuring range), Ethernet (32 bit)
Analog output		4 ... 20 mA / 0 ... 5 V / 0 ... 10 V
Switching output		1 or 2 switching outputs (error & limit value): npn, pnp, push pull
Connection		Sensor with 3 m integrated cable with open ends
Mounting		Support points with locating holes for centering sleeves for reproducible clamping of the sensor 2 x M4 d
Temperature range	Storage	-20 ... 70°C (non-condensing)
	Operation	0 ... 50°C (non-condensing)
Shock (DIN EN 60068-2-27)		15 g / 6 ms in 3 axes
Vibration (DIN EN 60068-2-6)		15 g / 20 ... 500 Hz
Protection class (DIN EN 60529)		IP67
Material		Aluminum housing
Weight		< 660 g (sensor with 3 m OE)
Control and indicator elements <sup>[4]</sup>		Select & Function buttons: interface selection, mastering (zero), teaching, presets, quality slider, frequency factory setting; web interface for setup: application-specific presets, peak selection, video signal, freely selectable average data reduction, setup management, expert mode; 2 x color LEDs for power / status
Permissible ambient light		50,000 lx

### 3.4 Technical data Measuring range 10/25/100/200

Model	ILD5500-10	ILD5500-25	ILD5500-100	ILD5500-200
Measuring range	10 mm	25 mm	100 mm	200 mm
Start of measuring range	30 mm	40 mm	70 mm	100 mm
Mid of measuring range	35 mm	52.5 mm	120 mm	200 mm
End of measuring range	40 mm	65 mm	170 mm	300 mm
Linearity <sup>[5]</sup>	1.5 µm	3.75 µm	20 µm	40 µm
	0.015% FSO	0.015% FSO	0.02% FSO	0.02% FSO
Repeatability <sup>[6]</sup>	< 0,15 µm	< 0,375 µm	< 1,5 µm	< 3 µm

[1] Factory setting: 20 kHz

[2] Related to digital output in the mid of the measuring range; the specified value is only achieved by mounting on a metallic sensor holder. Good heat dissipation from the sensor to the holder must be ensured.

[3] PROFINET and EtherNet/IP require connection via interface module IF2035 (see accessories)

[4] Access to web interface requires connection to PC

[5]

Value applies only to the standard measuring range; FSO = Full Scale Output; the specified data apply to white, diffuse reflecting surfaces (Micro)

[6] Measuring rate 20 kHz, median 9



Model		ILD5500-10	ILD5500-25	ILD5500-100	ILD5500-200
Light spot diameter <sup>[7]</sup>	SMR	85 x 200 µm	140 x 310 µm	230 x 500 µm	780 x 1800 µm
	MMR	60 x 75 µm	60 x 90 µm	230 x 500 µm	780 x 1800 µm
	EMR	130 x 250 µm	230 x 380 µm	640 x 1100 µm	780 x 1800 µm
	smallest Ø	50 x 75 µm with 34.5 mm	60 x 80 µm with 51 mm	82 x 117 µm with 99 mm	-

### 3.5 Control and indicator elements

LED State	Meaning
Green	Measuring object within the measuring range
Yellow	Measuring object in the mid of the measuring range
Red	No distance value available, e.g. target outside the measuring range, too low reflection
Off	Laser switched off
LED Output	Meaning
Green	Measurement value output RS422 active, analog output off.
Yellow	Switching outputs are active RS422 or analog output can be switched on. The web interface can be switched on.
Red	Measured value output current 4 ... 20 mA or Voltage 0 ... 5 V or 0 ... 10 V active
Off	Sensor off, no supply



Tab. 3.1: LEDs on receiver

Button function	Meaning
	Sensor parameterization <ul style="list-style-type: none"> <li>during initialization of sensor: selection of interface and key function (mastering or teaching)</li> <li>in measurement mode: selection of the presets, averaging and measurement frequency functions</li> </ul>
Select button	Meaning
	<ul style="list-style-type: none"> <li>Sensor parameterization</li> <li>Teaching or mastering</li> </ul>

Tab. 3.2: Buttons on the receiver

[7] ±10 %; SMR = start of measuring range; MMR = mid of measuring range; EMR = end of measuring range; light spot diameter determined with point-shaped laser with Gaussian fit (full 1/e<sup>2</sup> width)

## 4 Delivery

### 4.1 Delivery

- 1 Sensor ILD5500
  - 1 Installation instructions
  - 2 laser warning signs German, 2 laser warning signs English, 2 laser warning sign French
  - Accessories (2 pc. centering sleeves, 2 pc. M3 x 40)
- ▶ Carefully remove the components of the sensor from the packaging, handling them in such a way that no damage can occur.

i Do not touch the optical windows. Soiling of the optical windows will impair the functionality.

- ▶ Check the delivery for completeness and shipping damage immediately after unpacking.
- ▶ If there is damage or parts are missing, immediately contact the manufacturer or supplier.

Optional accessories are listed in the appendix.

### 4.2 Storage

Temperature range:	-20 ... +70 °C
Humidity:	5 ... 95 % RH (non-condensing)

## 5 Installation

### 5.1 Notes on operation

#### 5.1.1 Reflectance of target surface

In principle, the sensor evaluates the diffuse portion of the reflections of the laser light spot.

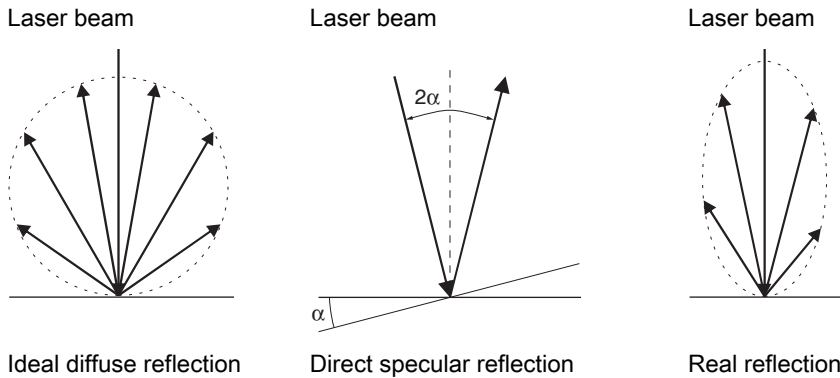

**Tab. 5.1: Reflectance of target surface**

Any statement about a minimum reflection factor is only possible with reservations, since small diffuse portions can be evaluated even of reflecting surfaces. This is done by determining the intensity of the diffuse reflection from the CMOS signal in real time and subsequent controlling, [see Chap. 3.2](#) However, a longer exposure time may be required for dark or shiny objects, such as black rubber. The maximum exposure time is coupled to the measuring rate and can only be increased by lowering the measuring rate of the sensor.

#### 5.1.2 Optimization of measurement accuracy

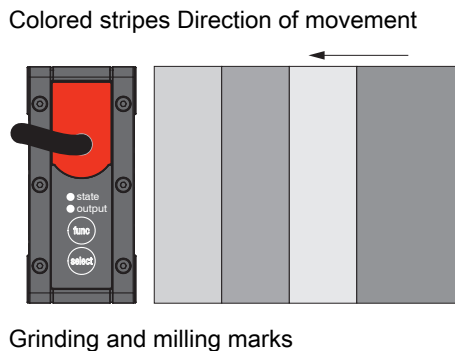

In case of rolled or polished metals that are moved past the sensor, the sensor plane must be arranged in the direction of the rolling or grinding marks. The same arrangement must be used for color strips.

**Tab. 5.2: Sensor arrangement for sanded or striped surfaces**

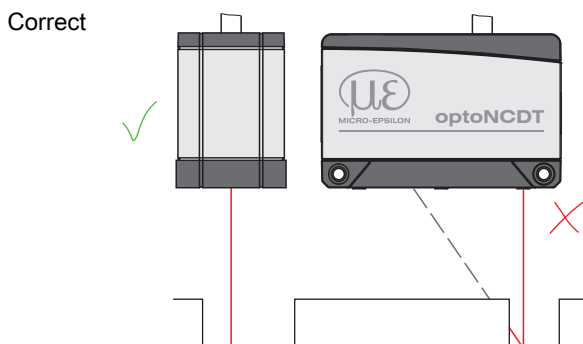

In case of bore holes, blind holes and edges in the surface of moving parts, the sensor must be arranged in such a way that the edge does not obscure the laser spot.

**Tab. 5.3: Sensor arrangement for holes and edges**

## 5.2 Mechanical fastening

### 5.2.1 General

The sensor is an optical system that measures in the  $\mu\text{m}$  range. If the laser beam does not strike the object surface at a perpendicular angle, measurements might be inaccurate.

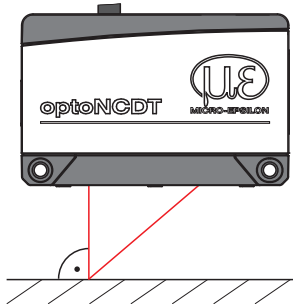

*Fig. 5.1: Sensor mounting with diffuse reflection*

The bearing surfaces surrounding the through-holes (fastening holes) are slightly raised.

- i Ensure careful handling of the sensor during installation and operation. Mount the sensor only to the existing through-bores on a flat surface. Any type of clamping is not permitted. Do not exceed torques.

### 5.2.2 Mounting, dimensional drawing ILD5500

Depending on the installation position, it is recommended to define the sensor position using centering elements and fitting bores. The cylindrical counterbore  $\varnothing 6$  H7 is intended for the position-defining centering elements. This allows for the sensor to be mounted in a reproducible and exchangeable way.

#### Bolt connection

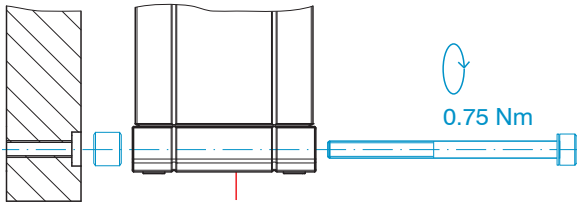

M3 x 40; ISO 4762, A2-70

#### Direct fastening

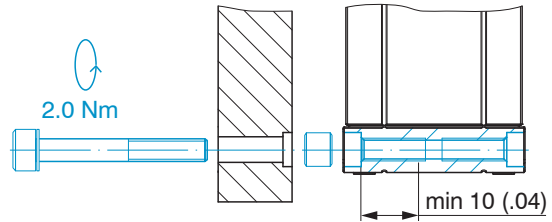

M4; ISO 4762, A2-70 | Screwing depth min. 10 mm

- i Only attach the sensor to the existing through-holes on a flat surface or screw it on directly. Any type of clamping is not permitted.

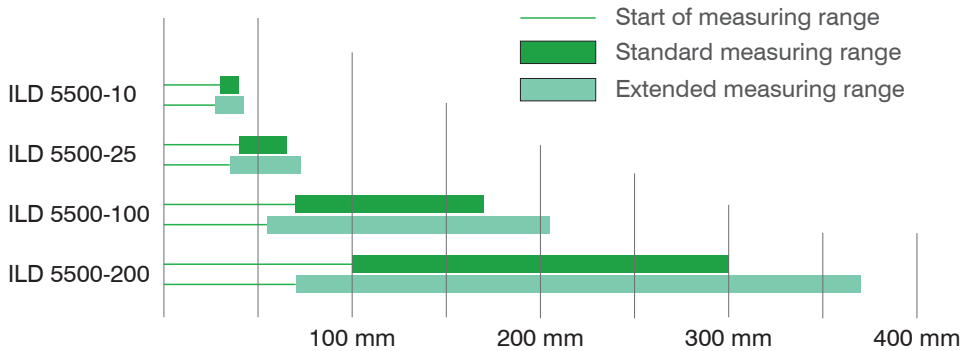

Fig. 5.2: Measuring ranges for distance measurement with extended and standard measuring range

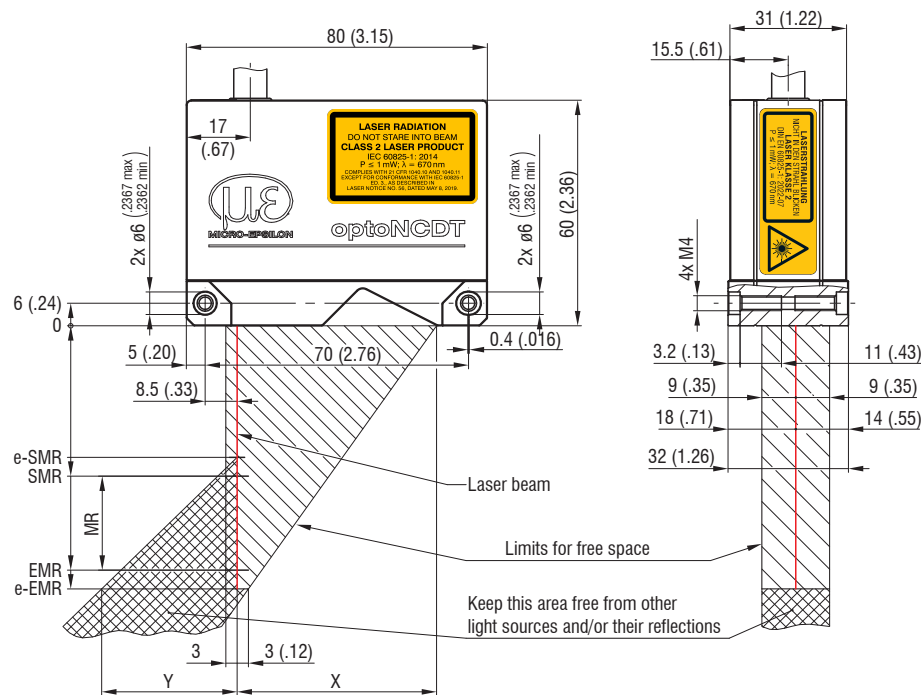

Fig. 5.3: Dimensional drawing ILD5500-10/25

MR <sup>[8]</sup>	100	200
e-SMR <sup>[9]</sup>	55	70
SMR <sup>[10]</sup>	70	100
MMR <sup>[11]</sup>	120	200
EMR <sup>[12]</sup>	170	300
e-EMR <sup>[9]</sup>	205	370
X standard MR	58	59
X with reserve MR	59	60
Y standard MR	64	92
Y with reserve MR	106	167

Tab. 5.4: Extended measuring range (reserve) and free space, ILD5500-100/200

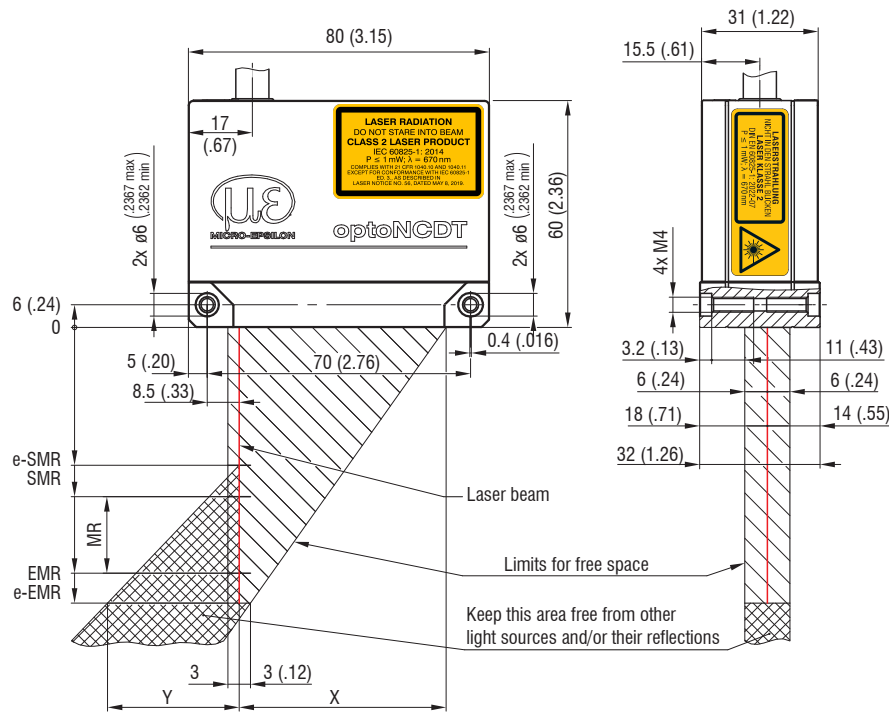

Fig. 5.4: Dimensional drawing ILD5500-100/200

- [8] MR = Measuring range
- [9] Reserve measuring range
- [10] SMR = Start of measuring range
- [11] MMR = Start of measuring range + 0.5\*measuring range
- [12] EMR = End of measuring range

### 5.3 Electrical connections

#### 5.3.1 Connection options

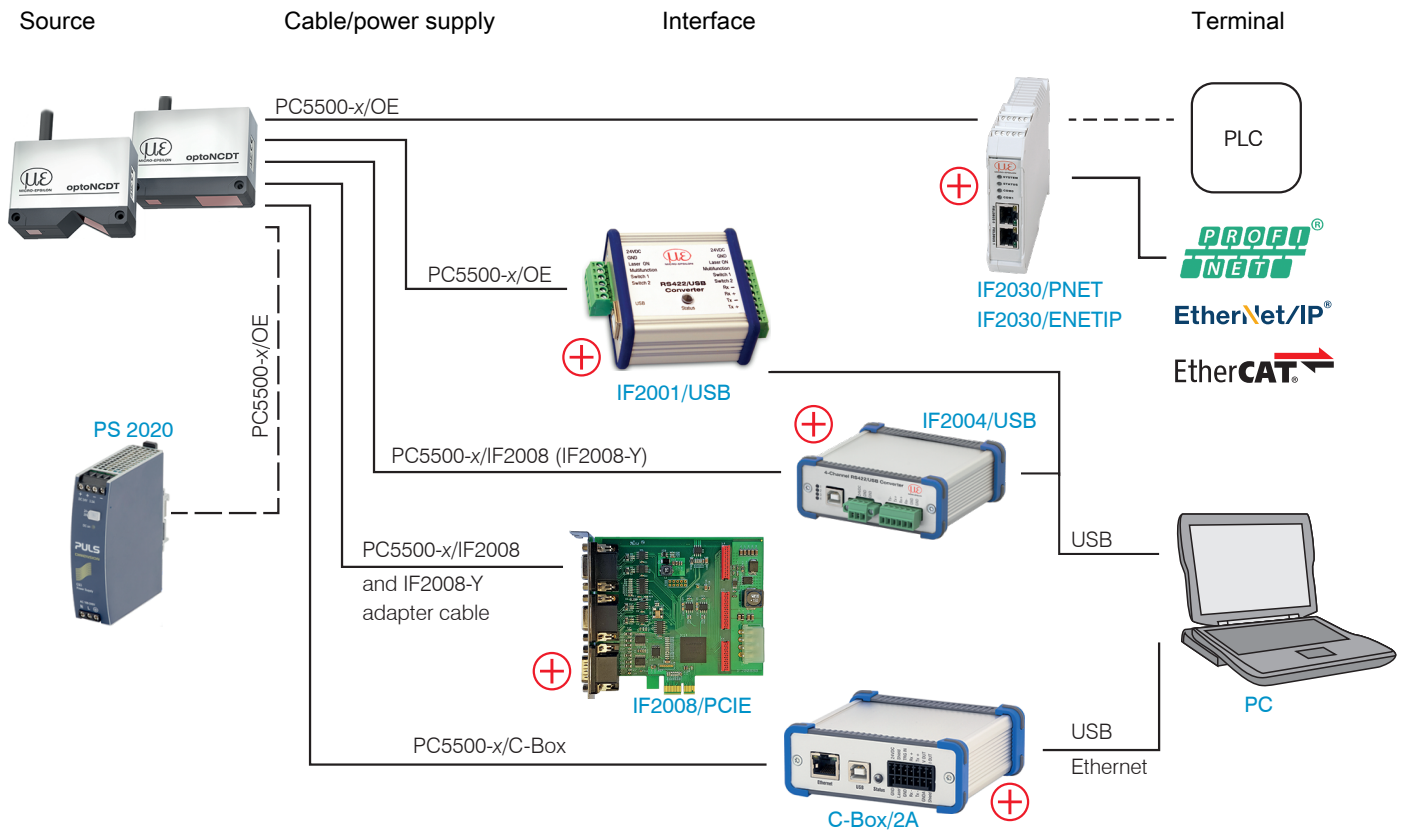



Fig. 5.5: Connection examples on ILD 5500

 Sensor supply via peripheral device.

#### 5.3.2 Pin assignment

Signal	Pin	Wire color PC/ SC5500-x	Notes
V <sub>+</sub>	24	Red	Supply voltage 12 ... 30 VDC, typically 24 VDC, max. 5 W
GND	17	Blue	Reference ground for Power, Sync, RS422
Sync +	5	Gray-pink	Synchronization or triggering Symmetrical, RS422 level, terminating resistor (120 ohm), direction can be switched using software, not electrically separated Alternative: Reference pulse encoder input
Sync -	2	Red-blue	
Tx +	9	Gray-black	Interface RS422 (32 bit), symmetrical Rx internally terminated with 100 Ohm max. 4 Mbaud, full duplex not electrically separated
Tx -	7	Pink-black	
Rx +	6	Green-black	
Rx -	1	Yellow-black	
Out1	16	Brown	Switching outputs Programmable switching behavior: (NPN, PNP or push-pull) 24V logic (HTL)
Out2	8	White	
Multi_in	4	Violet	Switching input for triggering, zeroing/mastering or teaching
Laser_on/off	3	Black	Laser active when pin 3 is connected to GND
AGND	21	Coaxial screen	Reference potential for analog output

Analog output	12	Coax inside	Current 4 ... 20 mA Voltage 0 ... 5 VDC Voltage 0 ... 10 VDC
A_ENC 1+	23	White-gray	Encoder input Incremental signals A, B
A_ENC 1-	18	Gray-brown	
B_ENC 1+	22	White-pink	
B_ENC 1-	19	Pink-brown	
Ethernet shield	13	Eth shield	Industrial Ethernet
RX-Ethernet+	14	White-green	
RX-Ethernet-	10	Green	
TX-Ethernet+	20	White-orange	
TX-Ethernet-	11	Orange	
Shield		SHLD	

**Tab. 5.5: Pin assignment 24-pin M16 socket for supply, interfaces and IO**

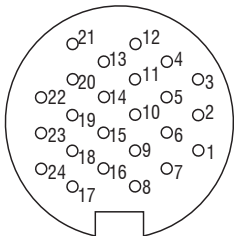

*Fig. 5.6: 24-pin sensor plug, M16, pin side view*

### 5.3.3 Supply voltage

Nominal value: 24 V DC (11 ... 30 V, P < 5 W).

- ▶ Only turn on the power supply after wiring has been completed.
- ▶ Connect the inputs “24 and “17” at the sensor with a 24V power supply.

Sensor Pin	PC5500-x/OE Color	Power supply	
24	Red	V+	
17	Blue	GND	

**Tab. 5.6: Supply voltage connection**

Voltage supply only for measuring devices, not to be used for drives or similar sources of impulse interference at the same time. Micro-Epsilon recommends using an optional available power supply unit PS2020 for the sensor.



### 5.3.4 Turning on the Laser

The measuring laser on the sensor is activated via a switch input (HTL or TTL level). This is advantageous if the sensor has to be switched off for maintenance or similar. Switching can be done with a transistor (for example open collector in an optocoupler), a relay contact or a digital TTL/HTL signal.

i If pin 3 is not connected electrically with Pin 17, the laser is off.

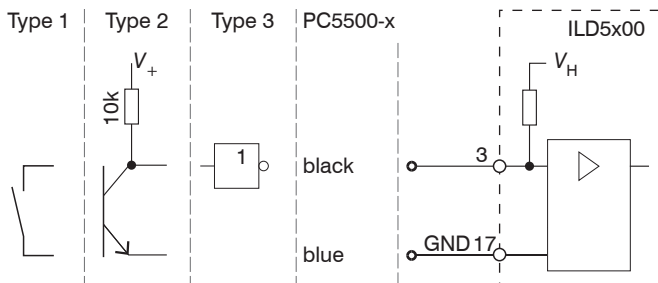

Fig. 5.7: Electrical wiring for laser on/off

Inputs are not galvanically isolated.

24 V logic (HTL): Low  $\leq 3$  V, High  $\geq 8$  V (max 30 V)

5 V logic (TTL): Low  $\leq 0,8$  V, High  $\geq 2$  V

Internal pull-up resistor, an open input is identified as High.

Max. switching frequency 10 Hz

There is no external resistor for current limiting required. Connect Pin 3 with Pin 17 for permanent „Laser on“.

Reaction Time for Laser-On: After the laser was switched on, correct measuring data are sent by the sensor approximately 10 ms later.

### 5.3.5 Connector and Sensor Cable

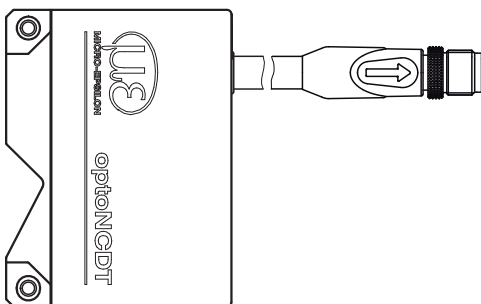

ILD5500 with pigtail

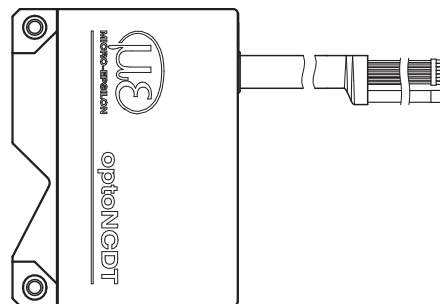

ILD5500 with open ends

- ▶ Never fall below the bending radius for the sensor cable of 30 mm (fixed) resp. 75 mm (dynamic).

i The fixed connected sensor cable is cable carriers suitable.

i Unused open cable ends must be insulated to protect against short circuits or malfunction of the sensor.

Micro-Epsilon recommends to use the cable carriers suitable standard connection cable PC5500 of the optional accessories.

## 6 Operation

### 6.1 Operation via web interface

#### 6.1.1 Requirements

A web server is implemented in the sensor; the web interface contains, among other things, the current settings of the sensor and the peripherals. Operation is only possible while there is an RS422 connection to the sensor.

The sensor is connected to a PC/notebook via an RS422 converter/Ethernet, for example, and the supply voltage is applied.

sensorTOOL by MICRO-EPSILON is a piece of software that you can use to apply settings to the sensor and to view and document measurement data.

You can find this online at <https://www.micro-epsilon.com/download/software/sensorTOOL.exe>.

- ▶ Start the sensorTOOL program.

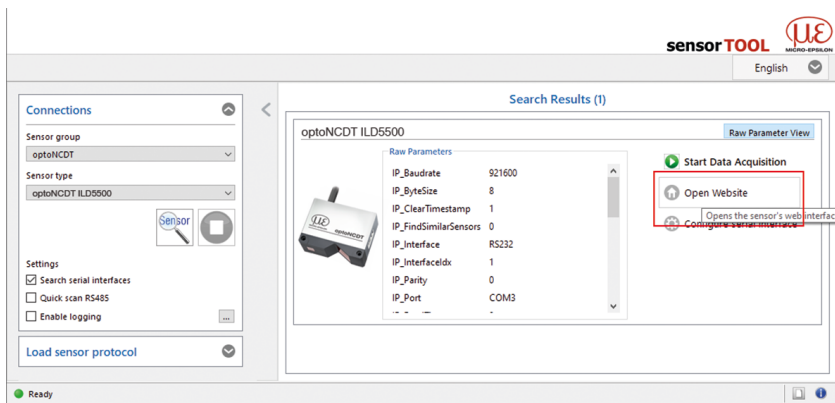

Fig. 6.1: sensorTOOL ILD5500

- ▶ Click the `Sensor` button.

The program searches for connected sensors of the ILD5500 series on the available interfaces. You need an HTML5-compatible web browser on a PC/notebook.

- ▶ Select a desired sensor. Click the `Open website` button.

## 6.1.2 Access via web interface

- ▶ Start the sensor's web interface, see Chap. 6.1.1.

Interactive web pages for configuring the sensor now appear in the web browser. The sensor is active and provides measurement values.

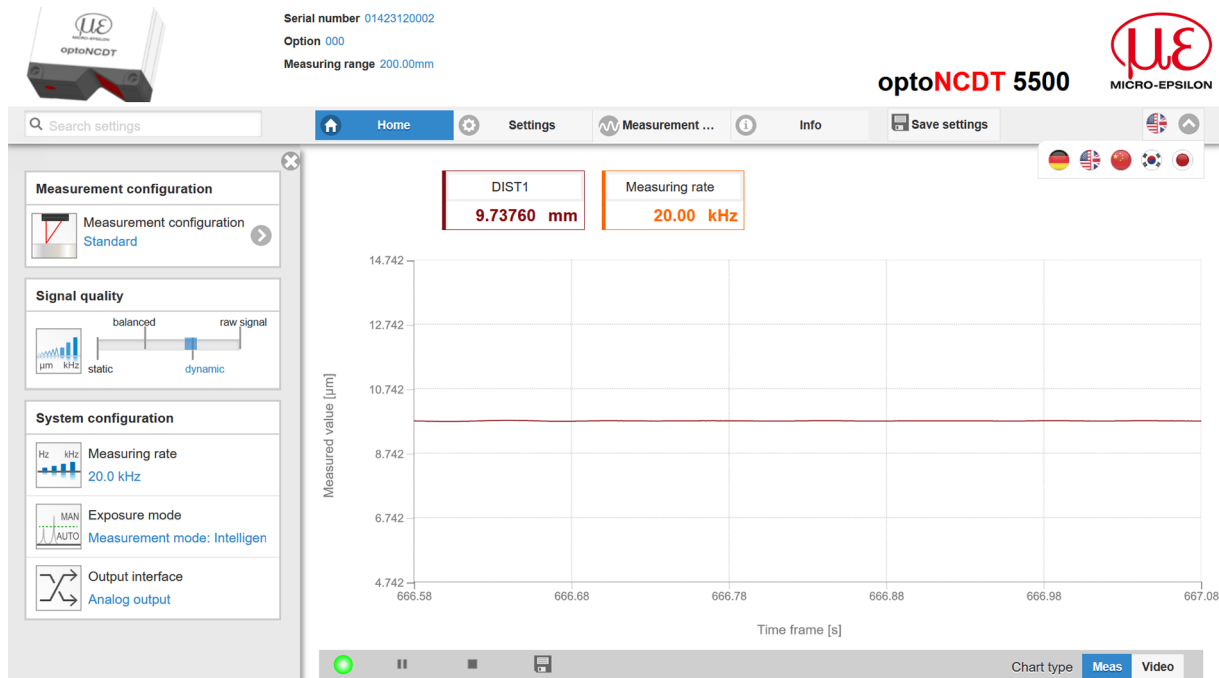

Fig. 6.2: First page after web interface has been accessed

The horizontal navigation contains the following functions:

- The search function enables time-saving access to functions and parameters.
- Home. The web interface starts automatically in this view with Measurement chart, Measurement configuration and Signal quality.
- Settings. This menu contains all sensor parameters.
- Measurement chart. Measurement chart with digital display or video signal display.
- Info. Contains information about the sensor, including serial number, software version and an overview of all sensor parameters.

- Web interface language selection

The appearance of the web pages may change depending on the functions. Dynamic help texts with excerpts from the operating instructions support you in configuring the sensor.

- i Depending on the selected measuring rate and the PC used, measured values may be reduced dynamically in the display. That is, not all measured values are transmitted to the web interface for display and saving.

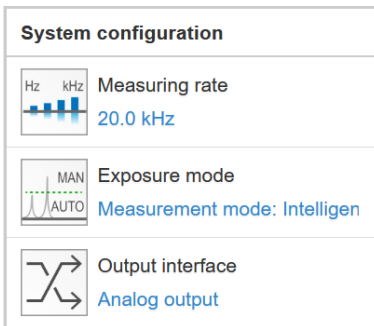

The `System configuration` section in the Home tab shows the current settings, including for the Measuring rate and Output interface in blue.

The Chart type section enables you to switch between the graphical presentation of a measurement value and the video signal.

## 6.2 Presets, Setups, selection of measurement configuration

### Definiton

- Preset: Manufacturer-specific program with settings for frequent measurement tasks; cannot be overwritten. Presets are available for the measuring ranges 10, 25, 100 und 200 mm.
- Setup: User-specific program with relevant settings for a measurement task.
- Initial setup at boot (sensor start): a favorite can be selected from the setups, which is automatically activated at sensor start. If no favorite is determined from the setups, the sensor activates the Standard preset at startup.

Upon delivery of the sensor from the factory

- the presets Standard, Multi-Surface and Light Penetration are possible
- no setups are available.

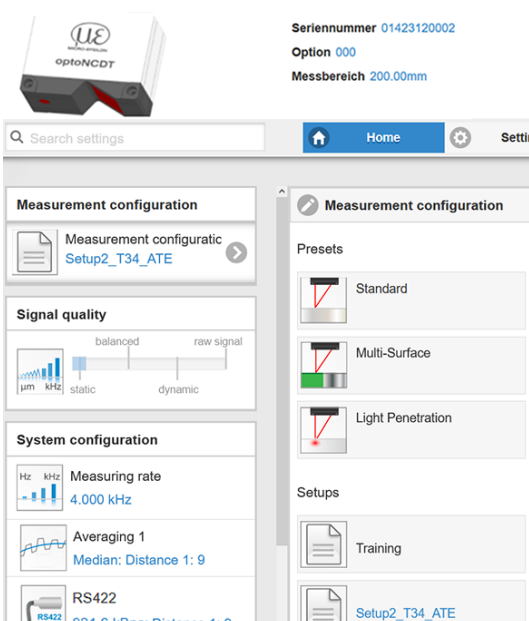

You can select a preset in the tab

- Home > Measurement configuration

You can select a setup in the tab

- Home > Measurement configuration
- Settings in the menu System settings > Load & save > Saved measurement settings

A maximum of 8 setups can be permanently stored in the controller.

Tab. 6.1: Extract from the web interface, Home tab

For all presets, the averaging can be individually adapted to the measurement task via the `Signal quality` slider.

i If the sensor starts with a user-specific measurement setting (setup), it is not possible to change the signal quality.

	Averaging	Description
	Balanced Median with 9 values + Moving with 64 values	In the Signal quality section you can switch between four predefined basic settings (static, balanced, dynamic and without averaging). The reaction in the chart and system configuration is immediately visible.
	Raw signal, without averaging	
	Static Median with 9 values + Moving with 128 values	
	Dynamic Median, 9 values	

Presets allow a quick start into the individual measurement task. Selecting a preset that matches the measuring object surface results in a predefined configuration of the settings that achieves the best results for the selected measuring object material.

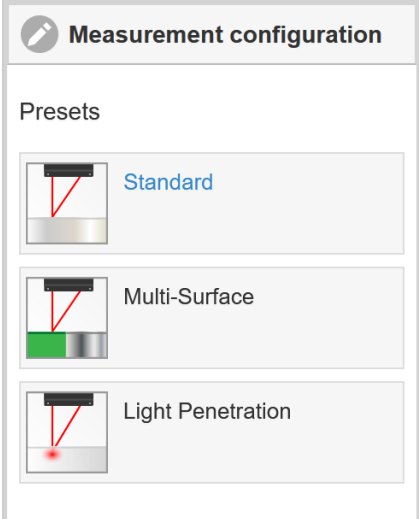
	Standard	ceramics, metal
	Multi-Surface <sup>[13]</sup>	PCBs, hybrid metal
	Light Penetration <sup>[13]</sup>	Plastics (Teflon, POM), materials with strong penetration depth of the laser

i After parameterization, store all settings permanently in a parameter set so that they are available again the next time the sensor is switched on. To do this, use the button. `Save settings` button.

6.3 Display of measurement values in the web browser

- ▶ Display the measurement values in the `Measurement chart` tab.

[13] Available for sensor models optoNCDT 5500 10/25/50/???

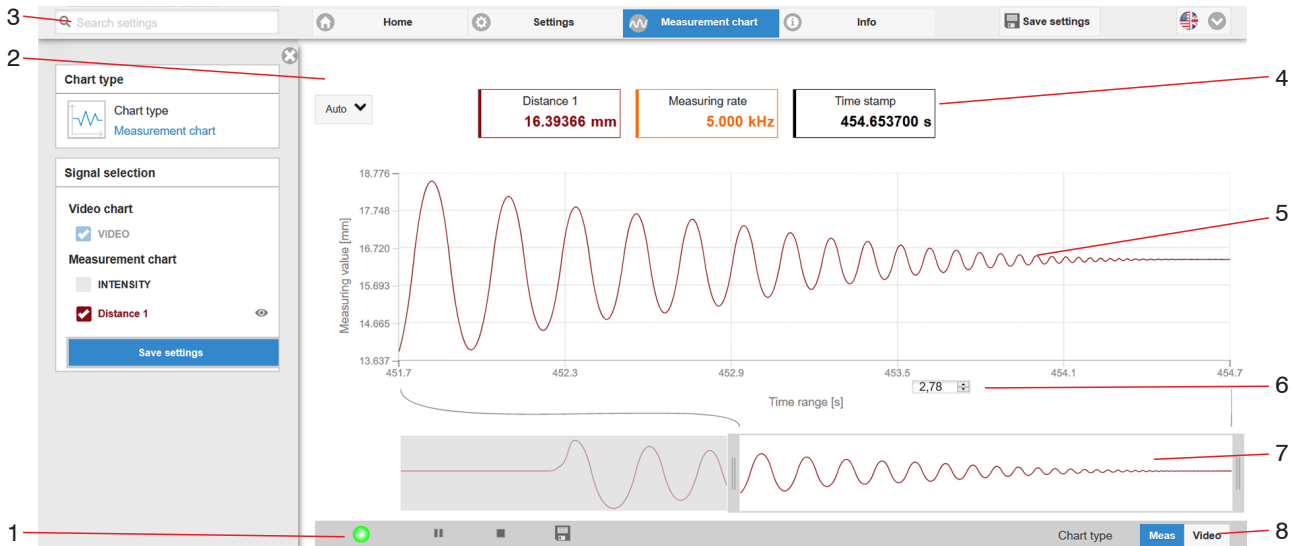

Fig. 6.3: Measurement (distance measurement) web page

- 1 The LED visualizes the status of the transmission of measured values:
  - green Transmission of measured values is running
  - yellow Waiting for data in trigger mode
  - gray Transmission of measured values stopped
 The data query is controlled using the buttons `Play/Pause/Stop/Save` of the transmitted measured values. `Stop` stops the chart; data selection and the zoom function are still possible. `Pause` Pauses the recording. `Save` opens the Windows selection dialog for the file name and storage location to save the last 10,000 values in a CSV file (separation using semicolon). Click on the `Start` button to display the measurement results.
- 2 To scale the axis in the graph for the measured values (y-axis), you can use `Auto` (= automatic scaling) or `Manual` (= manual scaling).
- 3 The search function permits time-saving access to functions and parameters.
- 4 The text boxes above the graphic display the current values for distance, exposure time, current measuring rate, display rate and time stamp.
- 5 Mouseover function. When the chart has been stopped and you move the mouse over the graph, points on the curve are marked with a circle and the associated values are displayed in the text boxes above the graph. Peak intensity is also updated.
- 6 The x-axis can be scaled in the input field under the time axis.
- 7 Scaling the x-axis: During an ongoing measurement, you can use the left-hand slider to enlarge the entire signal (zoom). When the chart has been stopped, the right-hand slider can also be used. You can also move the zoom window with the mouse in the center of the zoom window (four-sided arrow).
- 8 Select a chart type: measurement values or video signal

## 6.4 Video signal display in the web browser

- ▶ Display the video signal in the `Video` section of the `Chart type` selection.

The graph displayed in the large chart area on the right represents the video signal and the receiving row. The video signal displayed in the chart area displays the intensity distribution of the pixels in the receiving row. Left 0 % (small distance), and right 100 % (large distance). The corresponding measured value is marked by a vertical line (peak marking).

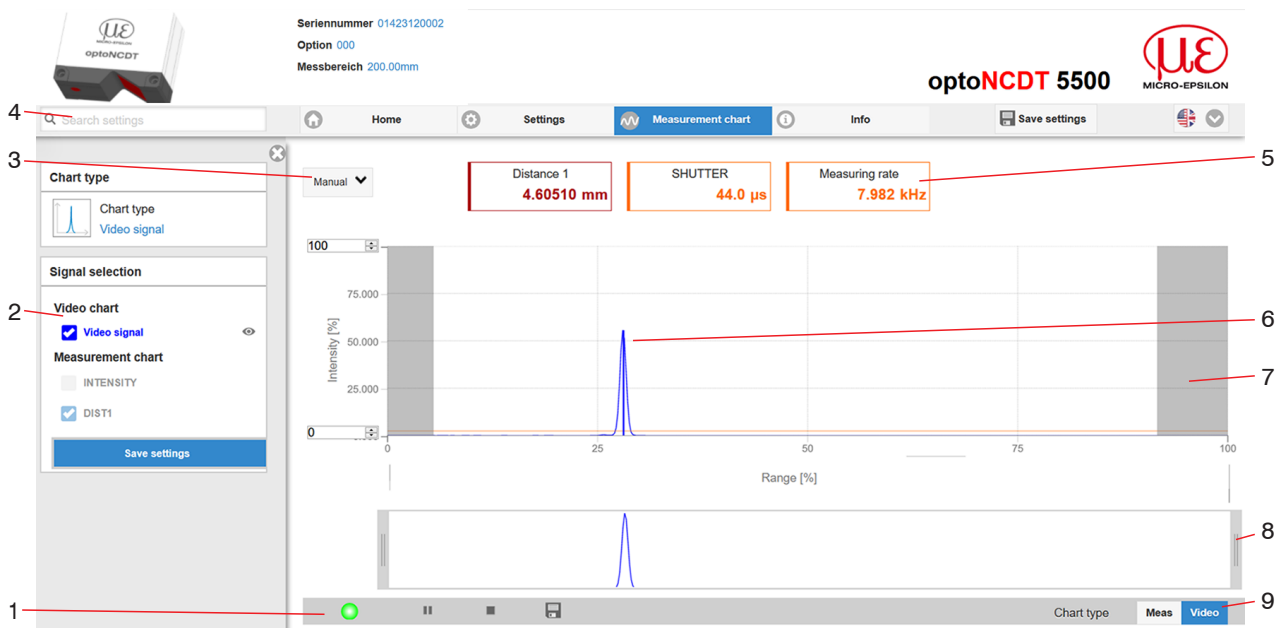

Fig. 6.4: Video signal web page

- 1 The LED visualizes the status of the transmission of measured values:
  - green Transmission of measured values is running
  - yellow Waiting for data in trigger mode
  - gray Transmission of measured values stopped
 The data query is controlled using the buttons *Play/Pause/Stop/Save* of the transmitted measured values *Stop* stops the chart; data selection and the zoom function are still possible. *Save* opens a Windows selection dialog for the file name and storage location to save the video signal in a CSV file. Click on the *Start* button to display the video signal.
- 2 In the left-hand window, the video channels to be displayed can be switched on or off during or after the measurement. Inactive curves are grayed out and can be added by clicking on the check mark. If you want to have displayed one single signal, click on its name.
  - Peak marking (vertical blue line), corresponds to the evaluated measurement value
  - Linearized measuring range (limited by gray hatching), not changeable
  - Masked range (limited by light blue hatching), changeable
- 3 For scaling the intensity axis (y-axis) of the graphic, you can either select *Auto* (= Auto-scaling) or *Manual* (= manual setting).
- 4 The search function permits time-saving access to functions and parameters.
 

i ASCII commands to the sensor can also be entered directly in the search field.
- 5 The text boxes display the current values for distance, exposure time, current measuring rate, display rate and time stamp.
- 6 Mouseover function. When stopped, moving the mouse over the graph marks curve points with a circle symbol and displays the associated intensity. The corresponding x position is displayed in % above the graph window.
- 7 The linearized range lies between the gray shades in the chart and cannot be changed. Only peaks whose middles lie within this range can be calculated as a measured value. The masked area can be restricted if required and is then limited on the right and left by an additional light blue shade. The peaks remaining in the resulting range are used for the evaluation.
- 8 X axis scaling: The chart displayed above is zoomable with both sliders on the right and on the left side in the lower total signal. It can also be moved sideways with the mouse in the middle of the zoom window (four-sided arrow).
- 9 Select a chart type: measurement values or video signal

The display shows how the adjustable measurement task (target material), peak selection and possible interfering signals due to reflections or similar affect the video signal. There is no linear relationship between the position of the peak in the video signal display and the output measured value.

## 6.5 Parameterization via ASCII commands

As an additional feature, you can parameterize the sensor via an ASCII interface, physically RS422. To do this, the sensor must either be connected to a serial interface RS422 using a suitable interface converter, [see Chap. 13](#), or a plug-in card to a PC/PLC.

Observe the correct RS422 basic setting in the programs used.

Once the connection has been established, you can transfer the commands from the appendix to the sensor via a terminal program.

## 6.6 Timing, measurement value cycles

The sensor requires 4 cycles to measure and process without triggering:

The cycle time is 13  $\mu\text{s}$  at a maximum measuring rate of 75 kHz. The measured value N is available at the output after four cycles. The delay time between detection and start of output is therefore at least 52  $\mu\text{s}$ . As the cycles are processed in parallel, the next measured value (N+1) is output after a further 13  $\mu\text{s}$ .



## 7 Digital interface RS422

### 7.1 Preliminary remarks

The RS422 interface has a maximum baud rate of 4 MBaud. The baud rate is set to 921.6 kBaud when the interface is delivered.

Data formats: Measured values in binary format, commands as ASCII character string

Interface parameters: 8 data bits, no parity, one stop bit (8N1)

- i Only disconnect or connect the Sub-D connection between the RS422 and the USB converter when the power is switched off.

### 7.2 Measurement data format

16 bits or 18 bits are transmitted per output value. An output value is distributed over three bytes, which differ in the two highest bits. The transfer of further output values is optional.

Output value 1 / more:

L-byte	0	0	D5	D4	D3	D2	D1	D0
M-byte	0	1	D11	D10	D9	D8	D7	D6
H-byte	1	0 <sup>[14]</sup>	D17	D16	D15	D14	D13	D12

**Tab. 7.1: Bit structure of an output value, output sequence: L byte, M byte, H byte**

### 7.3 Conversion of the binary data format

During conversion, the H byte, M byte and L byte must be recognized on the basis of the first two bits (identifier bits), the identifier bits removed and the remaining bits recombined to form an 18-bit data word.

D17	D16	D15	D14	D13	D12	D11	D10	D9	D8	D7	D6	D5	D4	D3	D2	D1	D0
-----	-----	-----	-----	-----	-----	-----	-----	----	----	----	----	----	----	----	----	----	----

**Tab. 7.2: Result of the conversion**

The conversion must always be done in the user program.

- i The sensor can continue to supply measurements to the RS422 output even while the sensor is communicating.

The IF2008/PCIE PCI-BUS interface card from MICRO-EPSILON, which is connected to the sensor via the optional PC5500-x/IF2008 interface cable, is suitable for data exchange with a PC. The IF2008/PCIE combines the three bytes of the data word and stores them in the FIFO. The 18 bits are used for measurement and error values. The IF2008 interface card can be connected to 2 sensors as standard or (optionally via a Y-intermediate cable) up to 4 sensors plus two additional incremental encoders. Further information can be found in the descriptions of the IF2008/PCIE interface card and the associated MEDAQLib driver program.

You can find the current program routine at: [www.micro-epsilon.de/link/software/medaqlib](http://www.micro-epsilon.de/link/software/medaqlib).

[14] For the last output value, bit 7 in the H byte is 0, which is also the identifier for the start of the block. For all previous output values in the same block, the 7th bit in the H byte is 1. Depending on the measuring rate, baud rate and output data rate, all output data can be output in one block. If the data output is overloaded, a corresponding error value is transmitted in the distance value. Data selection and output sequence is to be queried with the GETOUTINFO\_RS422 command.

## 8 Digital output values

### 8.1 RS422

Signal	Minimum	Maximum	Scaling	Unit
Exposure time	0	65536	Value / 10	µs
Measuring rate	250	75000	Value / 1000	kHz
Trigger time difference	0	40000	Value / 10	µs
Time stamp	-	-		µs
Time stamp HI	0	65536	Value * 65536	µs
Time stamp LO	0	65536	Value	µs
Measured value counter	0	262143	Value	
Status	0	262143	Bit 2: no peak found Bit 5: Distance before SMR (extended) Bit 6: Distance after EMR (extended) Bit 15: Measurement value is triggered Bit 16, 17: Status LED 00 – off 01 – red 10 – green 11 – yellow	
Unlinearized center of gravity	0	262143	Value / 256	Pixels
Intensity	0	4095	Value / 4096 * 100	%
Distance	0	262071	(Value - 98232) / 65536 * measuring range	mm
Trigger event counter	0	262143	Value	
Trigger value counter	0	262143	Value	
Minimum	0	262071	identical with distance	nm
Peak-peak	0	262071	identical with distance	nm
Maximum	0	262071	identical with distance	nm
Temperature	-511	+511	Value / 4	°C

**Tab. 8.1: Overview of digital output values RS422**

Value	Description
262075	Too much data for selected baud rate
262076	No peak is present
262077	Peak is before the measuring range (MR)
262078	Peak is after the measuring range (MR)
262080	Measurement value cannot be evaluated
262081	Peak is too wide
262082	Light source (laser) is switched off

**Tab. 8.2: Status information RS422**

### 8.2 Ethernet

Signal	Minimum	Maximum	Scaling	Unit
Exposure time	0	65536	Value / 10	µs
Measuring rate	250	50000	Value / 1000	kHz
Trigger time difference	0	40000	Value / 10	µs
Timestamp	0	UInt32		µs

Signal	Minimum	Maximum	Scaling	Unit
Timestamp HI	-	-		µs
Timestamp LO	-	-		µs
Measured value counter	0	Uint32	Value	
Status	0	Uint32	Bit 2: no peak found Bit 5: Distance before SMR (extended) Bit 6: Distance after EMR (extended) Bit 15: Measurement value is triggered Bit 16, 17: Status LED 00 – off 01 – red 10 – green 11 – yellow	
Unlinearized center of gravity	0	262143	Value / 256	Pixels
Intensity	0	4095	Value / 4096 * 100	%
Distance	0x80000000	0x7FFFFFF0	Value / 1000000	mm
Trigger event counter	0	Uint32	Value	
Trigger value counter	0	Uint32	Value	
Minimum	0x80000000	0x7FFFFFF0	identical with distance	nm
Peak-peak	0x80000000	0x7FFFFFF0	identical with distance	nm
Maximum	0x80000000	0x7FFFFFF0	identical with distance	nm
Temperature	-511	+511	Value / 4	°C

**Tab. 8.3: Overview of digital output values Ethernet**

Value	Description
0x7FFFFFF04	No peak is present
0x7FFFFFF05	Peak is before measuring range (MR)
0x7FFFFFF06	Peak is after the measuring range (MR)
0x7FFFFFF08	Measurement value cannot be evaluated
0x7FFFFFF09	Peak is too wide
0x7FFFFFF0A	Light source (laser) is switched off

**Tab. 8.4: Ethernet status information**

## 9 Cleaning

We recommend cleaning the protective glass at regular intervals.

### Dry cleaning

This can be accomplished with an anti-static lens brush or by blowing off the windows with dehumidified, clean, oil-free compressed air.

### Wet cleaning

Use a clean, soft, lint-free cloth or lens cleaning paper and pure alcohol (isopropyl alcohol) to clean the protective glass pane.

#### NOTICE

- ▶ Never use commercially available glass cleaner or other cleaning agents.

## 10 Service, repair

If the sensor or sensor cables are defective:

- If possible, save the current sensor settings in a parameter set to reload them into the sensor after the repair.
- Please send us the affected parts for repair or exchange.

If the cause of a fault cannot be clearly identified, please send the entire system including cables to:

MICRO-EPSILON  
Optronic GmbH  
Lessingstrasse 21  
01465 Dresden-Langebrück / Germany

Tel: +49 (0) 35201 729-0  
Fax: +49 (0) 35201 729 -90  
E-Mail: [optronic@micro-epsilon.de](mailto:optronic@micro-epsilon.de)  
[www.micro-epsilon.com/contact/worldwide/](http://www.micro-epsilon.com/contact/worldwide/)  
<https://www.micro-optronic.de/>

## 11 Decommissioning, disposal

In order to avoid the release of environmentally harmful substances and to ensure the reuse of valuable raw materials, we draw your attention to the following regulations and obligations:

- Remove all cables from the sensor and/or controller.
- Dispose of the sensor and/or the controller, its components and accessories, as well as the packaging materials in compliance with the applicable country-specific waste treatment and disposal regulations of the region of use.
- You are obliged to comply with all relevant national laws and regulations.

For Germany / the EU, the following (disposal) instructions apply in particular:

- Waste equipment marked with a crossed garbage can must not be disposed of with normal industrial waste (e.g. residual waste can or the yellow recycling bin) and must be disposed of separately. This avoids hazards to the environment due to incorrect disposal and ensures proper recycling of the old appliances.



- A list of national laws and contacts in the EU member states can be found at [https://ec.europa.eu/environment/topics/waste-and-recycling/waste-electrical-and-electronic-equipment-weee\\_en](https://ec.europa.eu/environment/topics/waste-and-recycling/waste-electrical-and-electronic-equipment-weee_en). Here you can inform yourself about the respective national collection and return points.

- Old devices can also be returned for disposal to Micro-Epsilon at the address given in the imprint at <https://www.micro-epsilon.com/legal-details>.

- We would like to point out that you are responsible for deleting the measurement-specific and personal data on the old devices to be disposed of.

- Under the registration number WEEE-Reg.-Nr. DE28605721, we are registered at the foundation Elektro-Altgeräte Register, Nordostpark 72, 90411 Nuremberg, as a manufacturer of electrical and/or electronic equipment.

## 12 Disclaimer

All components of the device have been checked and tested for functionality in the factory. However, should any defects occur despite careful quality control, these shall be reported immediately to Micro-Epsilon or to your distributor / retailer.

Micro-Epsilon undertakes no liability whatsoever for damage, loss or costs caused by or related in any way to the product, in particular consequential damage, e.g., due to

- non-observance of these instructions/this manual,
- improper use or improper handling (in particular due to improper installation, commissioning, operation and maintenance) of the product,
- repairs or modifications by third parties,
- the use of force or other handling by unqualified persons.

This limitation of liability also applies to defects resulting from normal wear and tear (e.g., to wearing parts) and in the event of non-compliance with the specified maintenance intervals (if applicable).

Micro-Epsilon is exclusively responsible for repairs. It is not permitted to make unauthorized structural and / or technical modifications or alterations to the product. In the interest of further development, Micro-Epsilon reserves the right to modify the design.

In addition, the General Terms of Business of Micro-Epsilon shall apply, which can be accessed under Legal details | Micro-Epsilon <https://www.micro-epsilon.com/legal-details/>.

## 13 Optional accessories

IF2001/USB

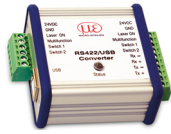

Single channel RS422 to USB converter  
connections: 1x female connector 10-pin (cable clamp) type Würth 691361100010, 1x female connector 6-pin (cable clamp) type Würth 691361100006

PS2020



Power supply unit for DIN rail mounting  
Input 230 VAC, output 24 VDC/2.5 A

IF2008/PCIE

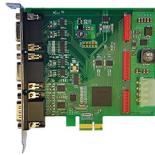

IF2008/PCIE interface card for the synchronous capture of 4 digital sensor signals or 2 encoders. In conjunction with the IF2008E, a total of 6 digital sensor signals, 2 encoders, 2 analog signals, and 8 I/O signals can be captured synchronously.

IF2004/USB



4-channel converter from RS422 to USB, suitable for cable PC/SC2700-3/IF2008; including driver, connections: 2 x sub-D, 1 x terminal block



## Index







MICRO-EPSILON MESSTECHNIK GmbH & Co. KG  
Königbacher Str. 15 94496 Ortenburg / Germany  
Tel. +49 (0) 8542 / 168-0 Fax +49 (0) 8542 / 168-90  
info@micro-epsilon.com [info@micro-epsilon.com](mailto:info@micro-epsilon.com)  
Your local contact: [www.micro-epsilon.com/contact/worldwide/](http://www.micro-epsilon.com/contact/worldwide/)

X9750486-A022104MSC  
© MICRO-EPSILON MESSTECHNIK