

Mini Probe

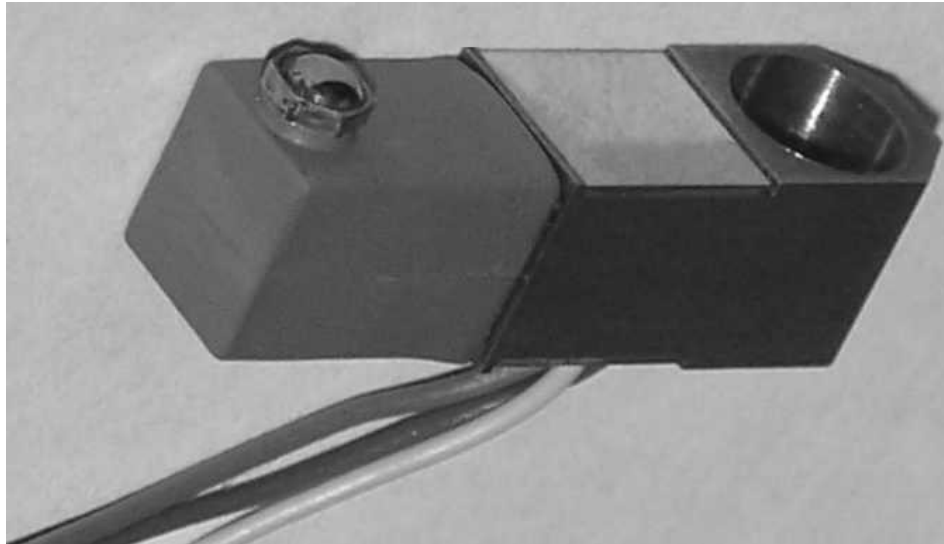

SCIGATE AUTOMATION (S) PTE LTD
No. 1 Bukit Batok Street 22 #01-01 Singapore 659592
Tel: (65) 6561 0488 Fax: (65) 6562 0588
Email: sales@scigate.com.sg Web: www.scigate.com.sg
Business Hours: Monday - Friday 8.30am - 6.15pm



user manual

AM Models



1.0: Index

Section Title	Page	Section Title	Page
1.0 Index	2	8.0 Outline Drawings.....	11
2.0 Safety Summary	3	8.1 Outline Drawings - AM/0.25/S.....	11
3.0 Introduction	4	8.2 Outline Drawings - AM/0.5/S.....	12
4.0 Components of the Mini Probe	5		
5.0 Mechanical Installation	6	Return of Goods	
5.1 Positioning	6	Solartron Sales Offices	
5.2 Mounting	6		
5.3 Cable	6		
5.4 Wiring	6		
5.5 Tip Adjustment	7		
5.6 Tip Replacement.	7		
6.0 Probe Connections	8		
7.0 Specifications.....	10		

2.0: Safety Summary

Terms in this Manual

WARNING statements identify conditions or practices that could result in personal injury or loss of life.

CAUTION statements identify conditions or practices that could result in damage to the equipment or other property.

Symbols in this manual



This symbol indicates where applicable cautionary or other information is to be found.

WARNINGS:

Do not operate in an explosive atmosphere

To avoid explosion, do not operate this equipment in an explosive atmosphere. This equipment is not intended for use in a safety critical environment.

NOTES:

This equipment contains no user serviceable parts

This equipment must be returned to your Solartron dealer for all servicing and repair.

Low Voltage

This equipment operates at below the SELV and is therefore outside the scope of the Low Voltage Directive.

3.0: Introduction

The Mini Probe is a compact, low profile, transducer intended for measurements in confined spaces. The product is based on a parallel spring structure that is significantly more robust than a single leaf arrangement. This greatly improves the reliability of the sensor, extending its working life and allowing it to be used in more demanding applications, such as automatic gauges. The parallel spring also insures a high level of repeatability, both on axis and across axis, so that it can be used in dynamic applications where profiling is required.



CAUTION

The Mini Probe needs to be treated carefully, as with any precision instrument, to avoid damage during installation - please see section 5 of this manual.

4.0: Components of the Mini Probe

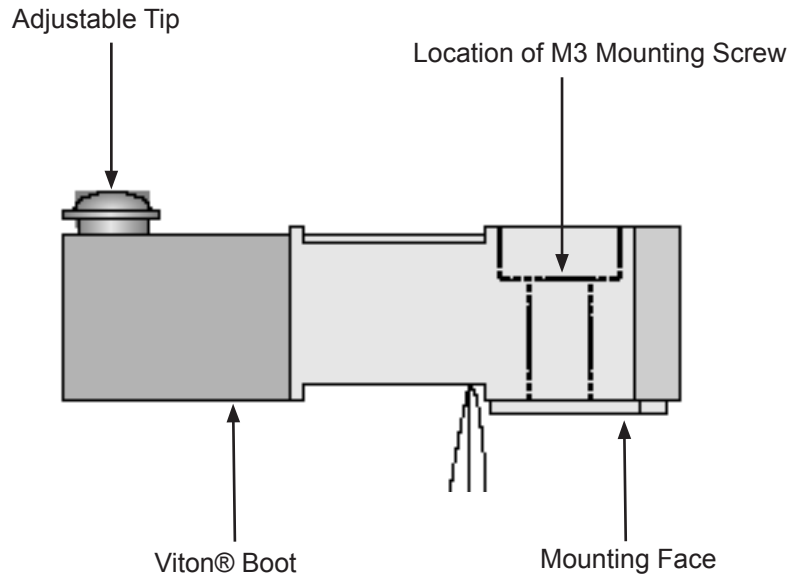

Viton® - Registered trademark of DuPont Performance Elastomers

5.0: Mechanical Installation

5.1: Positioning

The Mini Probe is susceptible to some degree to the influence of magnetic fields and should therefore be positioned well away from electric motors, relays and permanent magnets.

5.2: Mounting

The centreline of the Mini Probe is accurately aligned to one side of the transducer to provide a reference datum face. Similarly, the rear face and base mounting face of the Mini Probe can be used as a datum. These datum faces are shown on the CAD drawing in section 7.0.

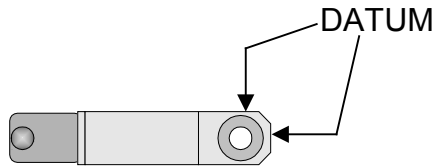

Installation is simply a matter of positioning the device, and securing it via a single M3 screw (supplied with the Mini Probe). The probe head may be mounted in any orientation..

5.3: Cable

To minimise transducer failure due to cable damage, cable runs should be positioned well clear of moving components and vulnerable working areas.

A minimum bend radius of 1mm is recommended for the wires coming out of the probe head. These wires should not be subjected to regular bending.

5.4: Wiring

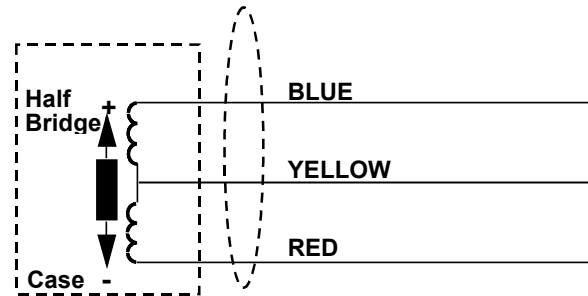

WARNING
When mounting the Mini Probe in a fixture, care must be taken as the probe can be damaged by the application of twisting forces.

5.0: Mechanical Installation

5.5: Tip Adjustment

The Mini Probe Tip height can be adjusted over a 0.5 mm range (± 0.25 mm from the factory set position - approximately $\pm 1/2$ turn).

To adjust tip

- 1) Firmly hold the Mini Probe frame as shown, so that it is not stressed during the tip adjustment

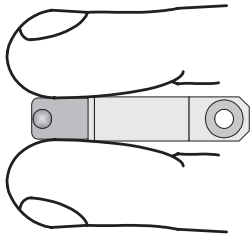

- 2) Using the spanner supplied, turn the tip until the required tip extension is achieved..



CAUTION

In order to avoid damage to the probe, it is critical that the Mini Probe is held firmly whilst the tip is being adjusted. Failure to do so will stress the assembly and may damage the structure beyond repair.

5.6: Tip Replacement

To remove tip

- 1) Firmly hold the Mini Probe frame, so that it is not stressed during the tip removal.
- 2) Using the spanner supplied, unscrew the tip from the Mini Probe.

To install tip

- 1) Firmly hold the Mini Probe frame, so that it is not stressed during the tip installation.
- 2) Using the spanner supplied, screw the replacement tip into the Mini Probe until the required tip extension is achieved. The tip is self-locking, so a tightening torque is not applicable. Do not tighten the tip against the stop.

6.0: Probe Connections

6.1: Probe Connections

To aid installation, the probe and connector cable may be separated. Two connection styles are used. Labels are provided on cables to ensure the connector cable can be matched with the corresponding probe head.

Pin to Pin Connection

Pull the in-line connections apart (handling the end of the connector only) and, at the same time, carefully slide back the sleeve to aid removal.

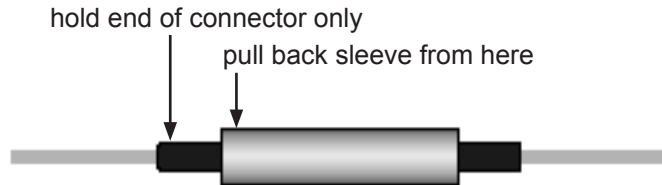

To reconnect, push the pin and socket together, feeling for the pin and socket making contact before finally pushing them together.

Alternatively, slide the sleeve back to expose the connector. Push the pin and socket together and then slide the sleeve back into position

Ensure connectors are mating before pushing together



Gently pull the ends of the sleeve to stretch it slightly. This puts a little tension into the sleeve and helps to pull the connector pins together.



When the probe is installed, ensure that the wires are not under tension. The connection method does not provide a positive locking. It is recommended that wires and cables are clamped or restrained in order to prevent the connectors being put under tension.

6.0: Probe Connections

6.1: Probe Connections (continued)

M5 Circular Connector

To separate the probe and connector cable, hold the probe connector and turn the locking ring only. When the locking ring is fully unscrewed the connector halves may be separated. Excessive cable twist may cause damage.

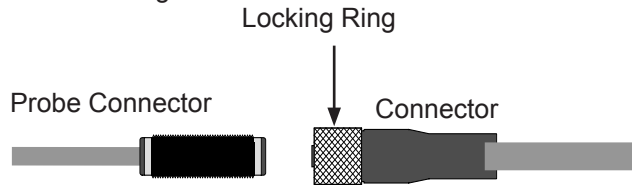

6.2: Grounding / Shielding

Pin to Pin Connection

It is recommended that the spade terminal be connected to the same metal work as the transducer. When multiple Mini Probes are being used, only one connection may be required. For installations where the connector cable and the probe are mounted close to each other on common metalwork, this extra connection may not be required.

The unshielded wires from the transducer should remain loosely twisted and be contained within (or remain in close proximity to) the metalwork.

These precautions will greatly improve the grounding / shielding aspects of the installation.

M5 Circular Connector

No additional screening precautions are required. The cable screens are continuous through the connector.

For additional advice regarding grounding and shielding, contact your original supplier.

7.0: Specifications

Specifications can be found on the Product Datasheet, which can be downloaded from www.solartronmetrology.com

