

Product Features:

- Compatible with Winmate M700DM8 Tablet PC
- Hold the tablet on the desk and support multiple I/O
- Supported I/O: 1 x COM, 1 x LAN, 2 x USB, DC-in (2.5Ø power jack input)
- Side I/O supported : 2 x USB

Mechanical Drawing

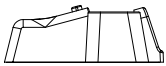
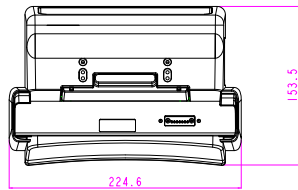

Front View

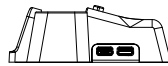

Side View

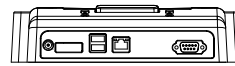

IO View

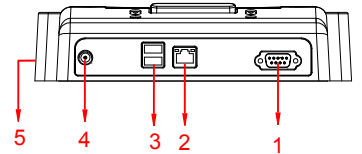

1. 1 x COM (RS232)
2. 1 x LAN (10/100)
3. 2 x USB

4. DC-IN (2.5Ø)
5. 2 x USB

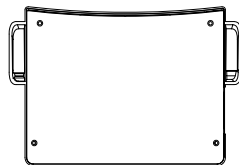

Installation Procedure

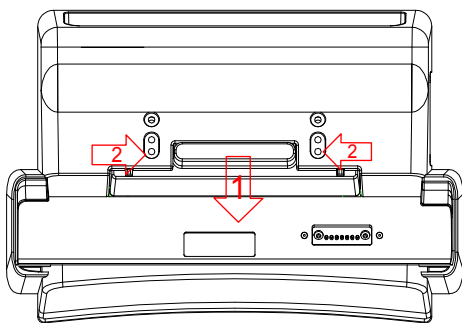

Top View

1. Pull down the latch
2. Insert the screw and tighten it
3. Insert the M700DM8 into the table docking, align the Pogo pin and make sure it is attached properly



SCIGATE AUTOMATION (S) PTE LTD

No.1 Bukit Batok Street 22 #01-01 Singapore 659592

Tel: (65) 6561 0488

Fax: (65) 6562 0588

Email: sales@scigate.com.sg

Web: www.scigate.com.sg

Business Hours: Monday - Friday 8.30am - 6.15pm



Rear View

Specification

Dimension	224.6 x 153.5 x 54.9 mm
Power Input	5V DC-in
I/O support	1 x COM, 1 x LAN, 2 x USB, DC-in (2.5Ø power jack)
Side I/O	2 x USB 2.0