

10.4" Flat Stainless P-Cap IP65 Panel PC (Intel® Celeron Bay Trail N2930 1.83GHz)

Flat Stainless P-Cap Chassis

MODEL #: R10IB3S-SPT2



Features:

- Intel® Celeron Bay Trail-M N2930 1.83GHz Processor
- Stainless housing, built to withstand the most demanding industries
- Sealed to IP65 for protection against water and dust
- A true flat, easy-to-clean front surface with edge-to-edge design
- Flat multi-touch panel pc with superior readability and P-Cap technology
- Various mounting solutions, Yoke mount and VESA mount
- Plenty of I/O s including USB 2.0, RS232 serial port and RJ45-10/100/1000 LAN ports
- Waterproof ports with adapter cables for external connectivity
- Support Glove / Rain mode (on going)

IP65 connector / cable

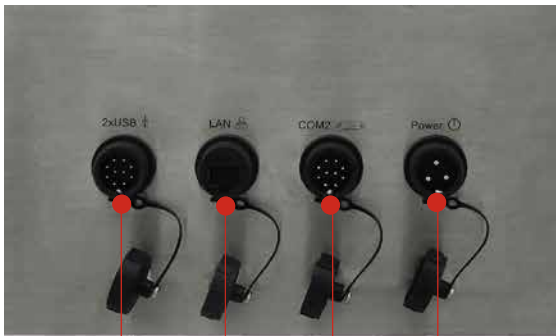

2 x USB2.0 LAN COM2 Power

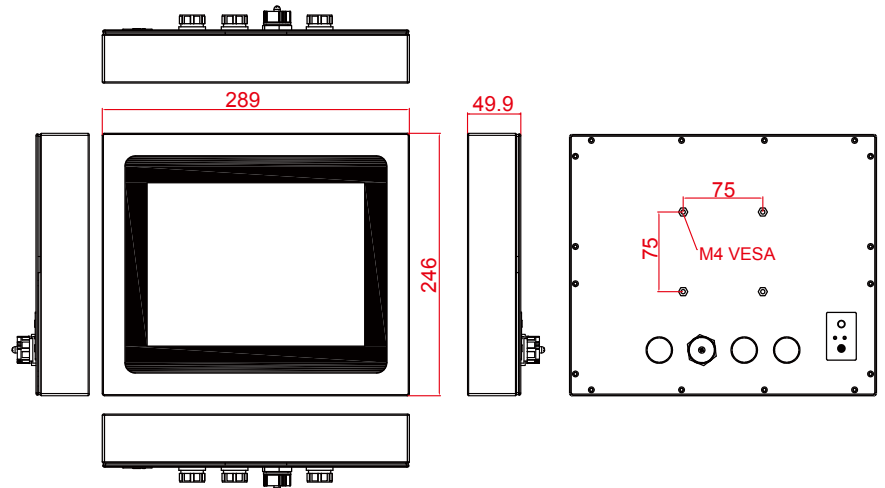

* Note: this is a simplified drawing and some components are not marked in detail. Please contact our sales representative if you need further product information.

System Specifications

TFT Characteristics :

- Resolutions : 1024 x 768
- Brightness : 350 cd/m² (typ.)
- Contrast Ratio : 1000 : 1 (typ.)
- Viewing Angles : -88~88(H);-88~88(V)
- Max Colors : 16.2M

Specifications :

- Processor : Intel® Celeron Bay Trail-M N2930 1.83GHz
- BIOS : AMI 16Mbit Flash
- System Chipset : Intel® Atom SoC Integrate
- Memory Slot : 1 x SO-DIMM, Default 4GB, Max 8GB DDR3L 1600
- Storage : Default 64GB
- Graphic Chipset : Integrated HD Graphics
- Ethernet : 2 x RJ45 Gigabit LAN (1 x RJ45 internal)
- Audio : Built in ALC886 HD Audio Codec
- USB : 6 x USB2.0 (4 x USB internal)
- Serial : 4 x RS232 (3 x RS232 internal)
- Expansion Slot : 1 x Mini PCIe (Internal)
- SSD Interface : 1 x Mini PCIe SSD
- Power Input : DC-IN (Lockable, Power Jack)
- Certification : CE, FCC, RoHS
- Security : Trusted Platform Module (TPM 1.2)

* A customized housing is needed if you would like to have more I/O connectors

Power Specifications :

- Power Input : 12V DC IN (Lockable Power Jack)
- Power Consumption : 33W (typ.)(Max.backlight & high CPU load)

Environment Considerations :

- Operating Temperature : 0 deg.C to 45deg.C
- Operating Humidity : 30% to 90% (non condensing)

Input/ Output Connectors :

- Ethernet LAN : 1 X RJ45 - 10/100/1000 Mbps
- COM : 1 x RS232
- USB : 2 x USB Type-A Receptacle
- Power : 1 x 12VDC

Accessories :

- External Power Supply 50W w/power cord
- LAN Cable
- Serial Cable
- USB Cable
- VESA screws

Order Options :

SBC	PANEL PC
RAM : SODIMM DDR3L Max 8GB	OS : Windows 10 IoT Enterprise Windows Embedded 8.1 Industry Pro Windows Embedded 8 Standard Windows Embedded 7 Standard
Storage : Mini PCIe SSD	



10.4" Flat Stainless P-Cap IP65 Panel PC (Intel® Celeron Bay Trail N2930 1.83GHz)

Flat Stainless P-Cap Chassis

MODEL #: R10IB3S-SPT2

Pin Assignment of cables

Power Cable

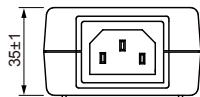
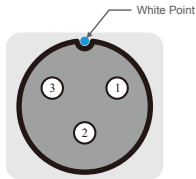
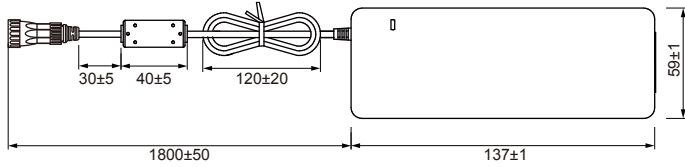

Pin No.	Symbols	Color
CN1-3	GND	Black
CN1-2	shield	
CN1-1	VCC	White

LAN Cable

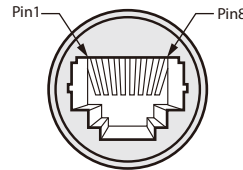
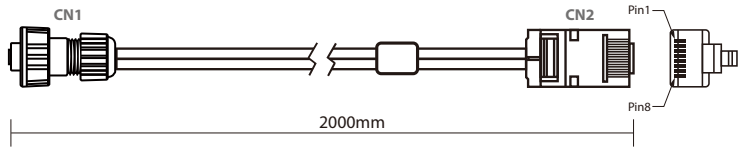

Plug	Wire Color	Conn.	
1	Orange / White	1	Twist
2	Orange	2	
3	Green / White	3	Twist
4	Blue	4	
5	Blue / White	5	Twist
6	Green	6	
7	Brown / White	7	Twist
8	Brown	8	

Serial Cable

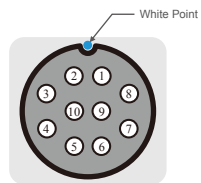
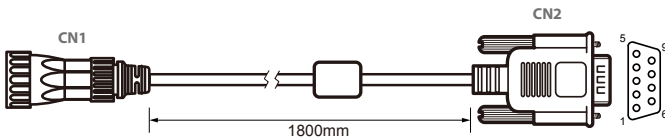

Pin No.	Symbols	Color
CN1-1	DCD-CON2	Green
CN1-2	DSR-CON2	Brown
CN1-3	RXD-CON2	Red
CN1-4	RTS-CON2	Orange
CN1-5	TXD-CON2	Blue
CN1-6	CTS-CON2	White
CN1-7	DTR-CON2	Purple
CN1-8	RI-CON2	Yellow
CN1-9	GND-CON2	Black
CN1-10	NC	

Pin No.	Symbols	Color
CN2-1	DCD-CON2	Green
CN2-2	DSR-CON2	Brown
CN2-3	RXD-CON2	Red
CN2-4	RTS-CON2	Orange
CN2-5	TXD-CON2	Blue
CN2-6	CTS-CON2	White
CN2-7	DTR-CON2	Purple
CN2-8	RI-CON2	Yellow
CN2-9	GND-CON2	Black
CN2-10	NC	

USB Cable

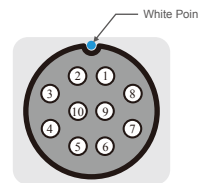
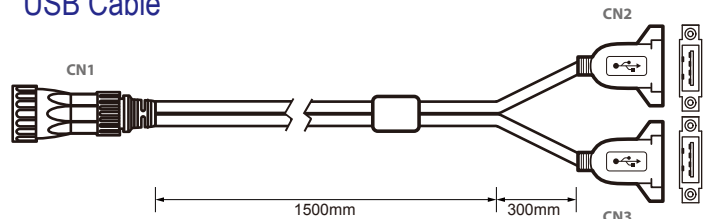

Pin No.	Symbols	Color
CN1-1	VCC	RED
CN1-2	VCC	RED
CN1-3	D-	WHITE
CN1-4	D-	WHITE
CN1-5	D+	GREEN
CN1-6	D+	GREEN
CN1-7	GND	BLACK
CN1-8	GND	BLACK
CN1-9	Braid	

Pin No.	Symbols	Color
CN2-1	VCC	RED
CN2-2	VCC	RED
CN2-3	D-	WHITE
CN2-4	D-	WHITE
CN2-5	D+	GREEN
CN2-6	D+	GREEN
CN2-7	GND	BLACK
CN2-8	GND	BLACK
CN2-9	Braid connect to the housing	

twisted pair

twisted pair



SCIGATE AUTOMATION (S) PTE LTD

No.1 Bukit Batok Street 22 #01-01 Singapore 659592

Tel: (65) 6561 0488

Fax: (65) 6562 0588

Email: sales@scigate.com.sg

Web: www.scigate.com.sg

Business Hours: Monday - Friday 8.30am - 6.15pm