

R19IC7T-PMM1 19" Panel PC (Intel® Core™ i7-620M/i5-520M)

Mechanical Design

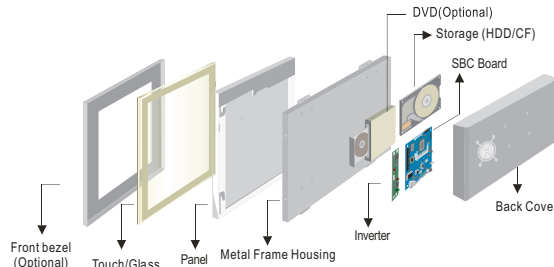

Panel Mount (8 mm front bezel)



Mechanical design

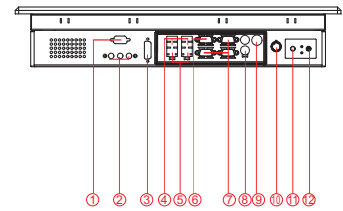

1. RS-232 Conn. (Optional)
2. Audio Jack
3. DVI (Optional)
4. USB
5. LAN
6. VGA
7. RS-232 Conn.
8. PS/2
9. DC-IN Lockable Power Jack
10. Brightness Adjustment Knob
11. Power On Button
12. Power Reset Button

Fully Integrated I/O

Dimensions

FRONT VIEW

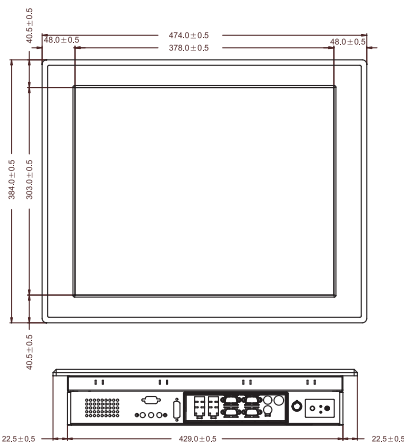

SIDE VIEW

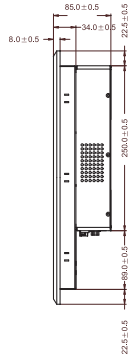

BACK VIEW

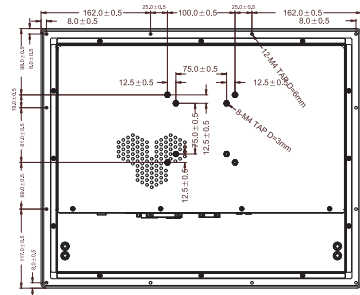

IP65 CUT OUT

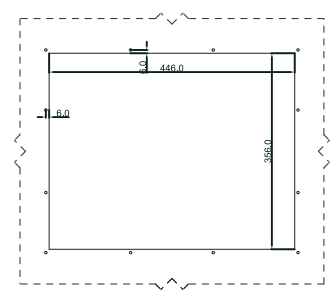

BOTTOM VIEW

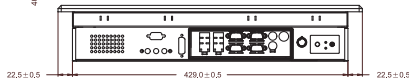

- * Measurements shown in mm
- * Tolerance of all dimensions is shown as follow 0~30 mm ± 0.1 mm, 30~50 mm ± 0.15 mm, 50~120 mm ± 0.2 mm, above 120 mm ± 0.25 mm
- * Note: this is a simplified drawing and some components are not marked in detail. Please contact our sales representative if you need further product information.

Specifications

System :

- CPU : Intel® Core™ i7-620M/i5-520M Processor (2.66GHz / 2.4GHz)
- Memory : 2 x SO-DIMM, Max 8GB DDR3 1066/800
- System Chipset : Intel® HM55 Chipset
- Storage : 2 x SATA II
- LAN : Dual Broadcom BCM57780 GbE
- Audio Codec : Realtek ALC886 HD Audio Codec

Input / Output :

- Serial Ports : 2 x RS232, 1 x RS232/422/485*
- USB Ports : 4 x USB
- Keyboard / Mouse : 2 x PS/2
- Ethernet : 2 x RJ45-10/100/1000Mbps
- VGA : 1 x VGA (female)

* Default setting:RS232

Expansion Slot :(internal)

- 1 x PCI-E(x16), 2 x Mini PCI-E

Power Specifications :

- Power Input : 12V DC IN (Lockable Power Jack)
- Power Consumption : 173W (typ.)(Max.backlight & high CPU load)

Accessories :

- External Adapter : 110~230V Ac-in 12V DC-output power adapter

Panel Spec :

- Size/Type : 19" TFT
- Resolutions : 1280 x 1024
- Brightness : 250 cd/m² (typ.)
- Contrast Ratio : 1000 : 1(typ.)
- Viewing Angles : -85~85(H);-80~80(V)
- Max Colors : 16.7M (8 bits/colors)

Environment Considerations :

- Operating Temperature : 0 deg.C to 50 deg.C
- Operating Humidity : 30% to 90% (non condensing)

OS BSP / Driver Support :

- Support Windows 7 / Windows XP Embedded / Windows XPP Embedded / Linux 2.6

Order Options :

- | | |
|---|--------------------------------|
| Mechanical : Panel Mount(8 mm bezel) | Storage : 2.5" HDD / mSATA SSD |
| Touch : 5 Wires Resistive or AR Protective Glass either one | RAM : SO-DIMM DDR3 1066/800 |
| | OS : Windows XPE (Optional) |
| | Windows XPPE (Optional) |
| | Windows 7 (Optional) |
| | Linux (Optional) |

(A customized housing is needed if you have demands of SAW/IR/IT/SC touch)

SCIGATE
Your Automation Partner

SCIGATE AUTOMATION (S) PTE LTD
No.1 Bukit Batok Street 22 #01-01 Singapore 659592
Tel: (65) 6561 0488 Fax: (65) 6562 0588
Email: sales@scigate.com.sg Web: www.scigate.com.sg

Business Hours: Monday - Friday 8.30am - 6.15pm



Note: All Specifications are subject to change without prior notice!

Revised Date: 11-May-2017 V1.2