

R19IH7T-OFA1

19" Panel PC (Intel® 4th Generation Core™ i5 Platform)

Mechanical Design



Open Frame

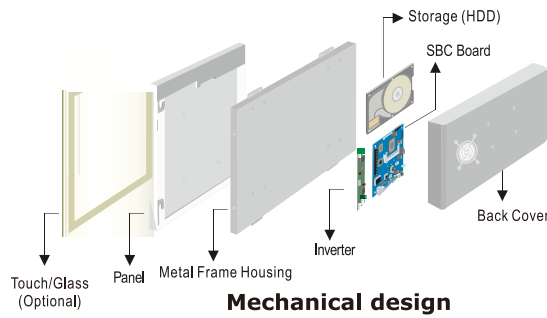

Mechanical design

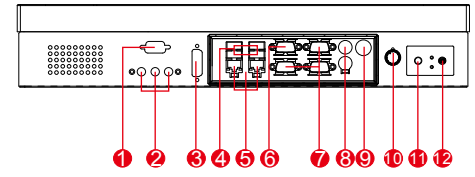

1. RS-232 Conn. (Optional)
2. Audio Jack
3. DVI (Optional)
4. USB
5. LAN
6. VGA
7. RS-232 Conn.
8. PS/2
9. 12V DC-in
10. Brightness Adjustment Knob
11. Power On Button
12. Power Reset Button

Fully Integrated I/O

Dimensions

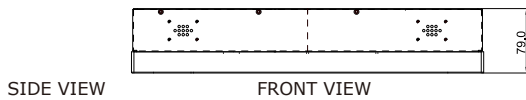

SIDE VIEW

FRONT VIEW

SIDE VIEW

BACK VIEW

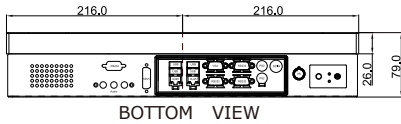
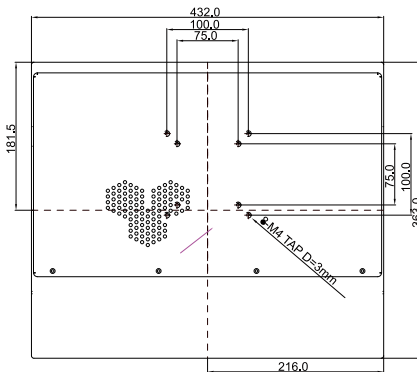
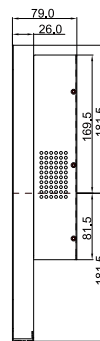
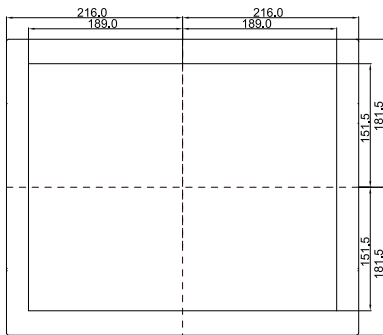
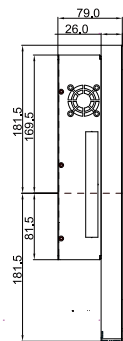

BOTTOM VIEW

- * Measurements shown in mm
- * Tolerance of all dimensions is shown as follow 0~30 mm ± 0.1 mm,
- * 30~50 mm ± 0.15 mm, 50~120 mm ± 0.2 mm, above 120 mm ± 0.25 mm
- * Note: this is a simplified drawing and some components are not marked in detail. Please contact our sales representative if you need further product information.

Specifications

System:

- CPU : Intel® 4th Generation Core™ i5-4200M 2.5GHz (Max. 3.1GHz) Processor
- Memory Slot : 2 x SO-DIMM, Max 16GB DDR3L 1333/1600
- System Chipset : Intel® QM87 Chipset
- IDE/SATA : 2XSATA III
- LAN : Intel® Ethernet Controller I211-AT + Intel® Gigabit Ethernet PHY I218-LM
- Audio Codec : Realtek ALC886 HD Audio Codec

Input / Output :

- Serial Ports : 2 x RS-232, 1 x RS-232/422/485
- USB Ports : 4 x USB 3.0
- Keyboard/Mouse : 2 x PS/2
- Ethernet : 2 x RJ45-10/100/1000 Mbps
- VGA : 1 x VGA
- Power : 1 x DC-in Power Jack(+12V)
- Audio : Line in, Line out, Mic in

Expansion Slot:

- 2 x Mini PCIe (1 for WiFi, 1 for 3G Module), 1 x PCI
- * A customized housing is needed if you would like to have the PCI expansion.

Power Specifications :

- Power Input : 12V DC IN
- Power Consumption : 60W (typ.)(Max.backlight & high CPU load)

Accessories :

- External Adapter : 110~240V Ac-in Power Adapter

Panel Spec :

- Size/Type : 19" TFT
- Resolutions : 1280 x 1024
- Brightness : 400 cd/m² (typ.)
- Contrast Ratio : 1000 : 1 (typ.)
- Viewing Angle : -85~85(H); -80~80(V)
- Max. Colors : 16.7M (8 bits/colors)

Environment Considerations :

- Operating Temperature : 0 deg.C to 50 deg.C
- Operating Humidity : 30% to 90% (non condensing)

OS BSP / Driver Support :

- Support Windows 7 / Windows 8 embedded / Windows 10 IoT Enterprise

Order Options :

- | | |
|--------------------------------------|---|
| Mechanical : Open Frame | Storage : 2.5" HDD/mSATA SDD |
| Touch : 5 Wires Resistive (Optional) | RAM : DDR3L 1333/1600 MAX 16GB |
| | OS : Windows 7 / Windows 8 embedded / Windows 10 IoT Enterprise |
- (A customized housing is needed if you have demands of SAW/IR/SC touch)



SCIGATE AUTOMATION (S) PTE LTD

No.1 Bukit Batok Street 22 #01-01 Singapore 659592
 Tel: (65) 6561 0488 Fax: (65) 6562 0588
 Email: sales@scigate.com.sg Web: www.scigate.com.sg

Business Hours: Monday - Friday 8.30am - 6.15pm



Note: All Specifications are subject to change without prior notice!

2-Jun-2016 V1.2