

R20IC7T-IPA2 20.1" Panel PC (Intel® Core™ i7-620M/i5-520M)

Mechanical Design

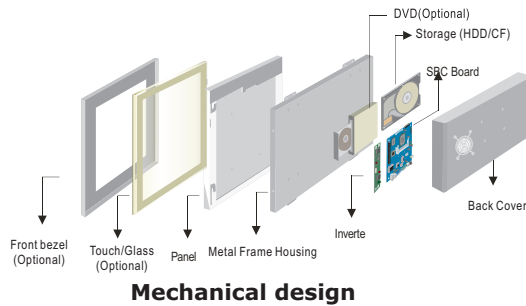

Mechanical design

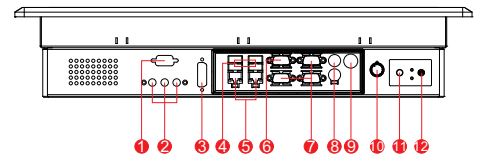

1. RS-232 Conn.(Optional)
2. Audio Jack
3. DVI(Optional)
4. USB
5. LAN
6. VGA
7. RS-232 Conn.
8. PS/2
9. DC-IN Power Jack
10. Brightness Adjustment Knob
11. Power On Button
12. Power Reset Button

IP65 (10 mm front bezel)

Fully Integrated I/O

Dimensions

IP65 CUT OUT

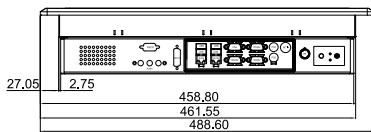
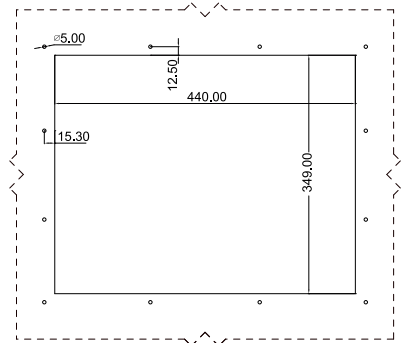
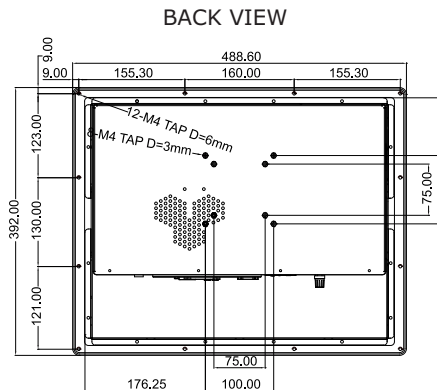
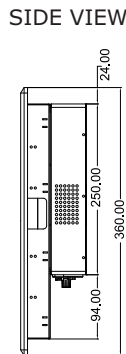
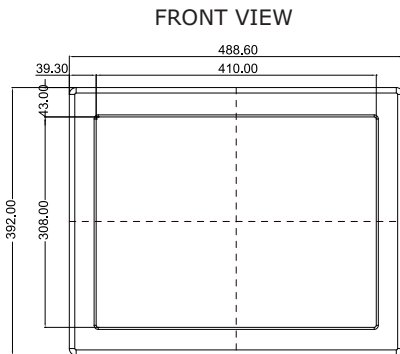

BOTTOM VIEW

- * Measurements shown in mm
- * Tolerance of all dimensions is shown as follow 0~30 mm ± 0.1mm, 30~50 mm ± 0.15 mm, 50~120 mm ± 0.2 mm, above 120 mm ± 0.25 mm
- * Note: this is a simplified drawing and some components are not marked in detail. Please contact our sales representative if you need further product information.

Specifications

System :

- CPU : Intel® Core™ i7-620M/i5-520M Processor (2.66GHz / 2.4GHz)
- Memory Slot : 2 x SO-DIMM, Max 8GB DDR3 1066/800
- System Chipset : Intel® HM55
- Storage : 2 x SATA II
- LAN : Dual Broadcom BCM57780 GbE
- Audio Codec : Realtek ALC886 HD Audio Codec

Panel Spec :

- Size/Type : 20.1" TFT
- Resolutions : 1600 x1200
- Brightness : 300 cd/m² (typ.)
- Contrast Ratio : 800 : 1(typ.)
- Viewing Angles : -89~89(H);-89~89(V)
- Max Colors : 16.7M (8 bits/colors)

Input / Output :

- Serial Ports : 2 x RS232, 1 x RS232/422/485
- USB Ports : 4 x USB
- Keyboard / Mouse : 2 x PS/2
- Ethernet : 2 x RJ45-10/100/1000Mbps
- VGA : 1 x VGA (female)

• Default setting:RS232

Environment Considerations :

- Operating Temperature : 0 deg.C to 50 deg.C
- Operating Humidity : 30% to 90% (non condensing)

Expansion Slot :

- 1 x PCI-E(x16), 2 x Mini PCI-E

Order Options :

Mechanical : Open Frame	Storage : 3.5" HDD/CF/Both
Panel Mount(5mm bezel)	RAM : SO-0DIMM DDR3 1066/800
IP65(10mm bezel)	OS : Windows XPPE (Optional)
Touch : 5 Wires Resistive(Optional)	Windows XPPE (Optional)
	Windows 7 (Optional)
	Linux (Optional)
	DVD : Yes

(A customized housing is needed if you have demands of SAW/IR/IT/SC touch)

Power Specifications :

- Power Input : 12V DC IN (Lockable Power Jack)
- Power Consumption : 195W (typ.)(Max.backlight & high CPU load)

Accessories :

- External Adapter : 110~230V Ac-in power adapter



SCIGATE AUTOMATION (S) PTE LTD

No.1 Bukit Batok Street 22 #01-01 Singapore 659592
 Tel: (65) 6561 0488 Fax: (65) 6562 0588
 Email: sales@scigate.com.sg Web: www.scigate.com.sg

Business Hours: Monday - Friday 8.30am - 6.15pm

