



SCIGATE AUTOMATION (S) PTE LTD

No.1 Bukit Batok Street 22 #01-01 Singapore 659592

Tel: (65) 6561 0488 Fax: (65) 6562 0588

Email: sales@scigate.com.sg Web: www.scigate.com.sg

Business Hours: Monday - Friday 8.30am - 6.15pm

VIBRATION TYPE LEVEL SWITCH

Model **KVX/XV2**

**HIGHLY SENSITIVE & COMPACT VIBRATION LEVEL SWITCH
MEETING DEMANDING PROCESSES AS WELL AS
HARD REQUIREMENTS**

DETECTING HYPOBARIC POWDER;

Standard Type can detect an object of apparent specific gravity from 0.1 or over while

Optional Type can do one from 0.03 or over.



**Reliably Detect Any Materials Whose Specific Conductivity
Or Electrical Properties May Be Varied. Because The Sensitivity Is At
The Tip Of The Sensing Plate, It May Not Be Affected By Fouling Or Build-Up At
The Plate-Root. With The Development Of New Mechanism And
New Circuitry, It Has Greatly Been Upgraded In
Terms Of Sensitivity And Reliability**

APPLICABLE TO POWDER WHOSE DETECTION IS DIFFICULT DUE TO THE SMALL APPARENT SPECIFIC GRAVITY, AND YET IT IS USER-FRIENDLY.

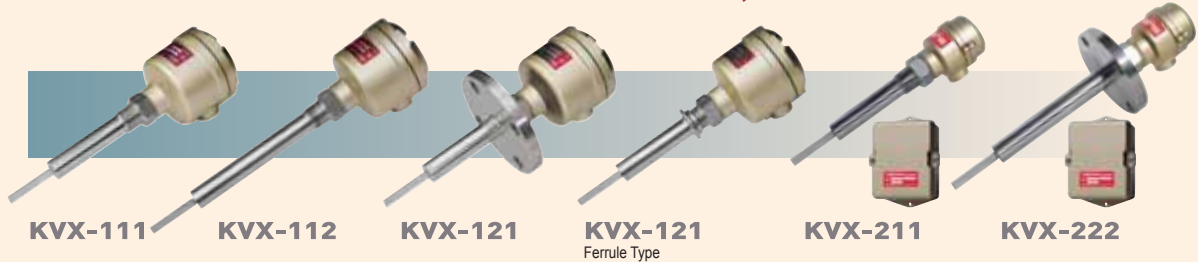

KVX SERIES FEATURES

- Well suited to detection of such small-gravity powders that other instruments can not measure.
- Applicable to an object whose conductivity or specific gravity varies.
- Simple operation without complex sensitivity adjustment.
- Easy maintenance with few driving parts.
- Pressure resistant with no sealing part.
- Highly sensitive to detect fine and light powders. (Specific gravity : more than 0.1) (Specific gravity : 0.03, available as option)
- Applicable to liquids.
- A remote box is prepared as a vibration countermeasure.
- An operating lamp is fixed.
- 2 types of L dimension = 180mm, 250mm

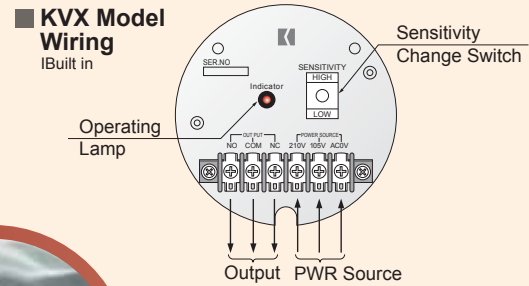

PRINCIPLE OF OPERATION

When an object gets in touch with a rod oscillated by piezoelectricity, vibration damping takes place. This damping is transferred to a relay output.

Lightweight/Compact/Quality Level Switch !!

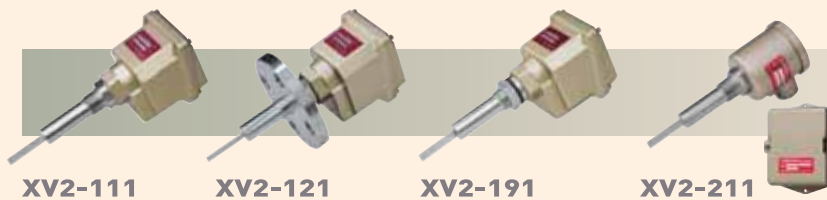

XV2 SERIES FEATURES

Besides the same performance as that of KVX series, it is compact and lightweight. It is the level switch developed to meet the downsizing requirements in particular.

XV2 Model Wiring Built-in

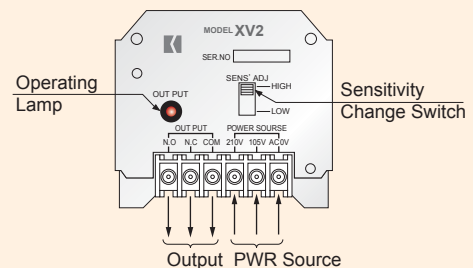

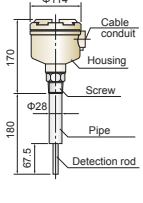
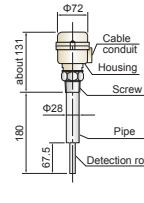
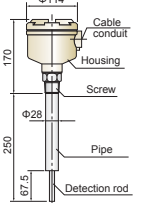
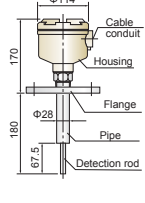
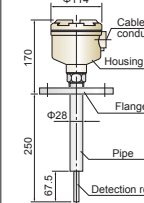
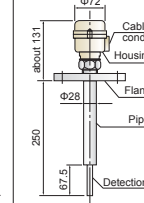
KVX Standard Model & Specification						
	Model	KVX-111	KVX-211	KVX-112	KVX-121	KVX-122
Installation	R1	R1	R1	JIS10K50A	JIS10K50A	JIS10K50A
Conduit	G 3/4	G 1/2	G 3/4		G 1/2	
Sensitivity	Specific Gravity over 0.1 (over 0.03 as option)					
Sens. Adjustment	2 sensitivity Levels (Switchable H & L * L level at factory setting)					
Contact Capacity	250VAC 10A (30VDC 10A)					
Power Source	105 / 210VAC ±10% (24VDC as option)					
Consumption	4VA					
Pressure	980kPa					
Temp. inside	-20°C ~ +80°C (No condensation)					
Ambient Temp	-20°C ~ +60°C (No condensation)					
Rod Materialial	304SS (316LSS as option)					
Housing Materialial	ADC					
Cable Length	—	4m (10m as option)	—	—	—	4m(10m as option)
Protection Rank	IP-66	IP-55 equivalent	IP-66		IP-55 equivalent	
Angle Rod	Can be available (KVX-□□□-3)					
Sensitivity Volume	Can be available (Optional)					
Fouling Protection	Can be available (Optional)					
Detect sediments in water	Can be available (depending on condition)					
Weight	1.4Kg	1.0Kg	1.5Kg	3.6Kg	3.7Kg	3.4Kg

*Note: Flange and Ferrule are not weldable.

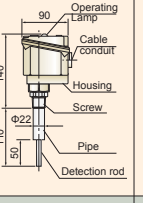
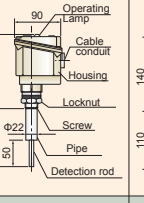
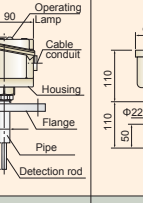
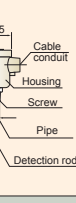
XV2 Standard Model & Specification				
	Model	XV2-111	XV2-191	XV2-121
Installation	R 3/4	G 3/4	JIS10K50A	R 3/4
Conduit	G 1/2			
Sensitivity	Specific Gravity over 0.1 (over 0.03 as option)			
Sens. Adjustment	2 sensitivity Levels (Switchable H & L * L level at factory setting)			
Contact Capacity	250V AC 5A (30V DC 5A)			
Power Source	105 / 210VAC ±10% (24VDC as option)			105V / 210V AC ±10%
Consumption	4VA			
Pressure	980kPa			
Temp. inside	-20°C ~ +80°C (No condensation)			
Ambient Temp	-20°C ~ +50°C (No condensation)			
Rod Materialial	304SS (316LSS as option)			
Housing Materialial	ADC			AC
Cable Length	—	—	—	4m
Protection	IP-55 equivalent			
Angle Rod	Can be available (XV2-□□□-3)			
Sensitivity Volume	Not available			
Fouling Protection	Not available			
Detect sediments in water	Not available			
Weight	1.0Kg	3.3Kg	0.8Kg	

* Note: Flange and Ferrule are not weldable.

■ KVX/XV2 REMOTE MODEL

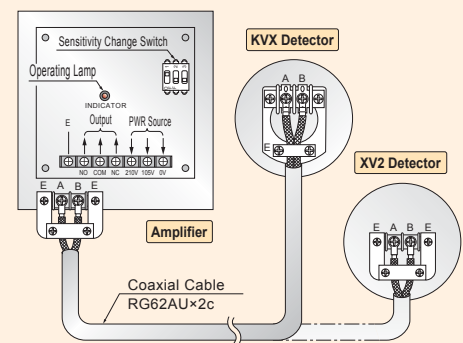

■ KVX/XV2 OUTDOOR WALL MOUNTING

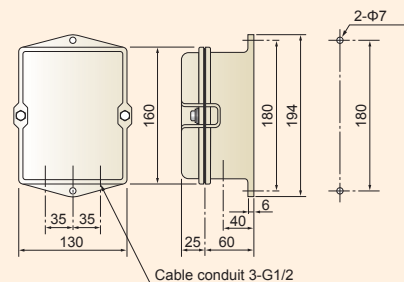

Color : Hammer-net gold
Weight : 1.7kg

DESIGNATION OF MODEL

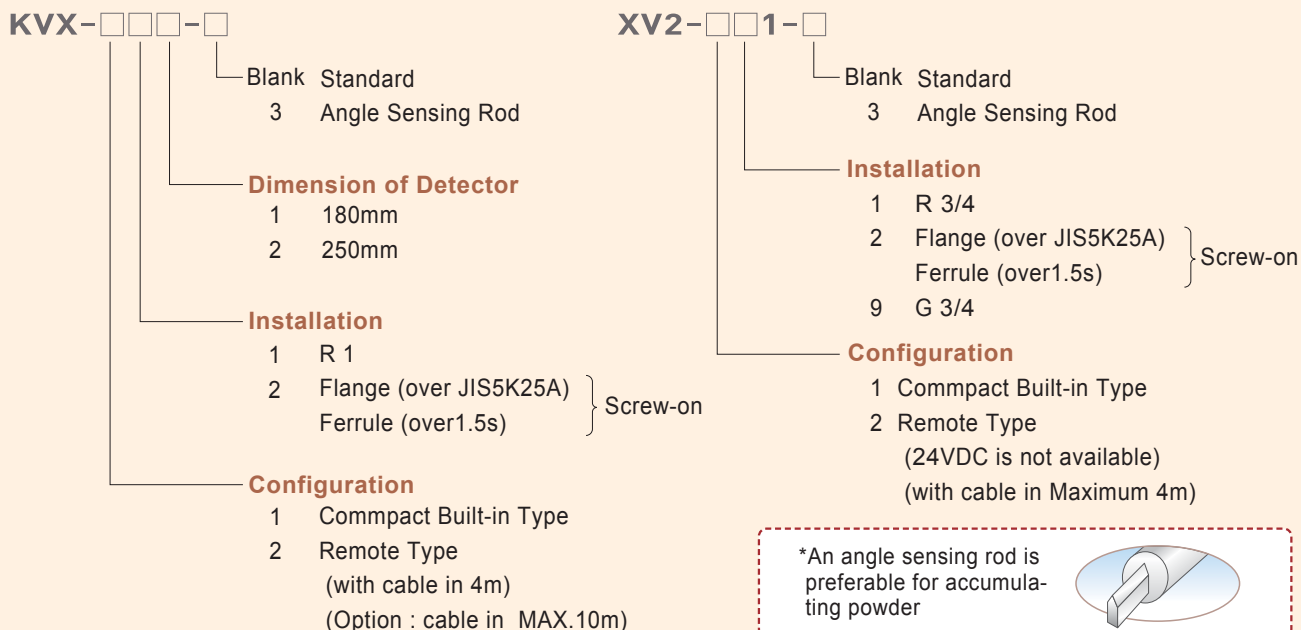

● NOTES FOR INSTALLATION

In case of horizontal mounting, make the cable conduit directly downward in both Flange and Screw mounting Types. An arrow on a hexagonal nut between the housing and the screw shows the mounting direction (KVX only). Make this arrow up on the hexagonal nut, while the conduit should face directly underneath. When screwing, so as to the correct direction, adjust the finishing angle with increasing or decreasing a thickness of sealant tape. When screwing, you should make the last angle adjustment within a 360 degree roll in rolling the seal tape up or down.

Apply an effective sealing material on the screw when you fix it. The detection rod must be completely protruded inside the tank.

Do not rotate the level switch with housing but with the hexagonal nut by spanner or wrench when you screw in the instrument.

Line of business

- Rotary Paddle Type Level Switch
- Vibration Type Level Switch
- Swing Type Level Switch
- Acoustic Level Switch
- Capacitance Type Level Switch
- Capacitive Proximity Sensor
- Capacitance Type Level Indicator
- Diaphragm Type Level Switch
- Tilt Switch
- Leak Type Level Switch
- Microwave Switch
- Sounding Bob Type Level Indicator
- Flow Switch
- Conductance Type Level Switch
- Float Switch
- Float Type Level Indicator
- Ultrasonic Type Level Indicator
- Equipments For Conveyor Lines
- Dust Monitor System
- Zirconia Oxygen Analyzer
- Laser Type Level Indicator
- RADAR Type Level Indicator
- On-line Sensors for Accurate Liquid Analysis
- Ultrasonic Flow meter

*Please be sure to read USER'S GUIDE, Installation & Operation Instructions before using the instrument.

*The specifications herein may be subject to change without advance notice.

Nuclear Power Generation to Rice Milling
All-round Manufacturer of Level Controllers for Powder, Granules and Liquid

KANSAI Automation Co., Ltd.

Headquarters :
2-14, Togano-cho, Kita-ku, Osaka 530-0056, Japan
TEL. 81-6-6312-2071 FAX. 81-6-6314-0848
e-mail: info@kansai-automation.co.jp

<http://www.kansai-automation.co.jp>

Tokyo Branch : 1-29-6, Hamamatsu-cho, Minato-ku, Tokyo 105-0013, Japan
TEL. 81-3-5777-6931 FAX. 81-3-5777-6933

Nagoya Office : 3-31-27, Uchiyama, Chigusa-ku, Nagoya 464-0075, Japan
TEL. 81-52-741-2432 FAX. 81-52-741-1588

Kyushu Office : 1-2-39, Asano, Kokura Kita-ku, Kitakyushu 802-0001, Japan
TEL. 81-93-511-4741 FAX. 81-93-511-4580



Design, development, and manufacture of level measuring sensors

Agent